

# 1

## Kit 145075

VOLKSWAGEN Arteon, 5-dr Hatchback, 17-



ISO 11154-E

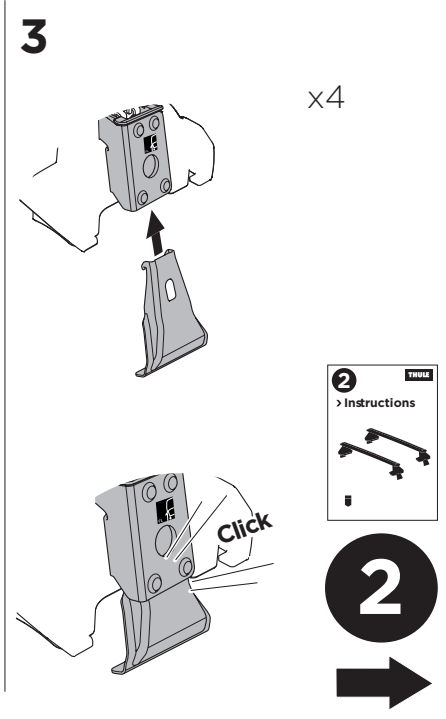
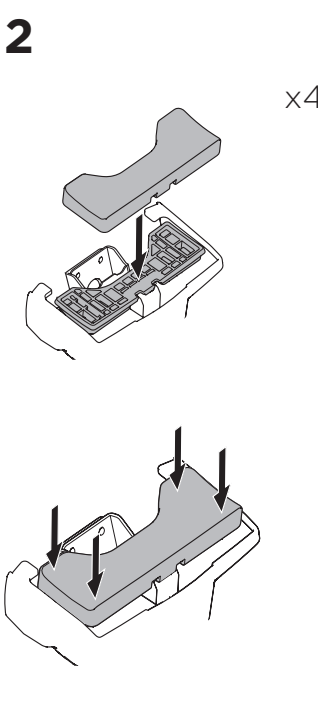
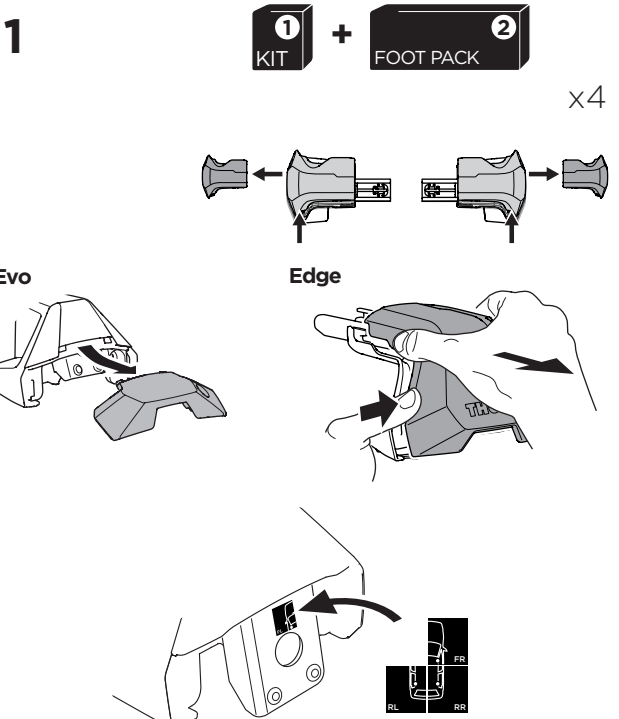
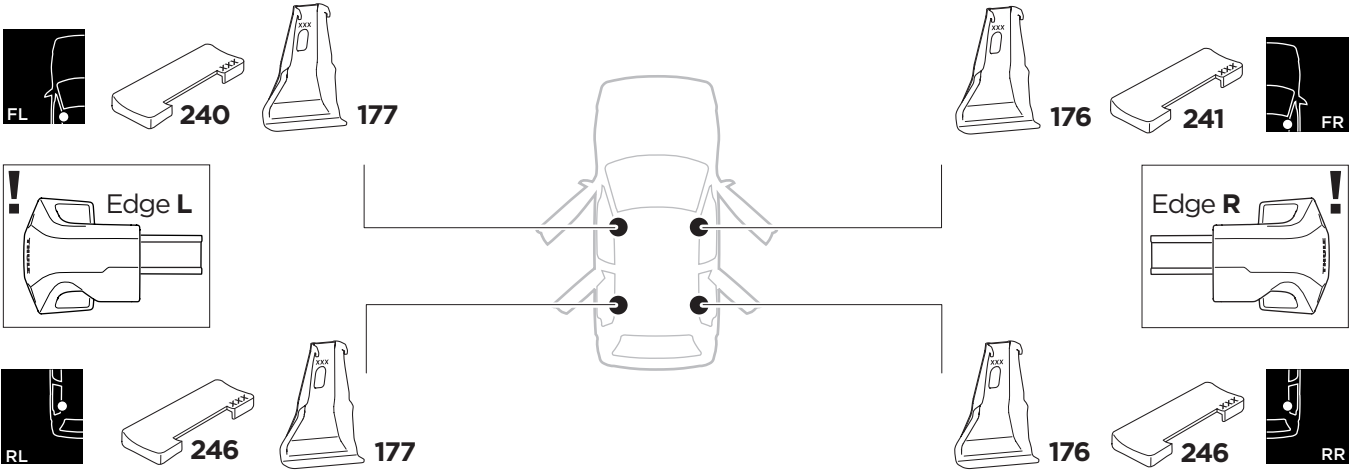
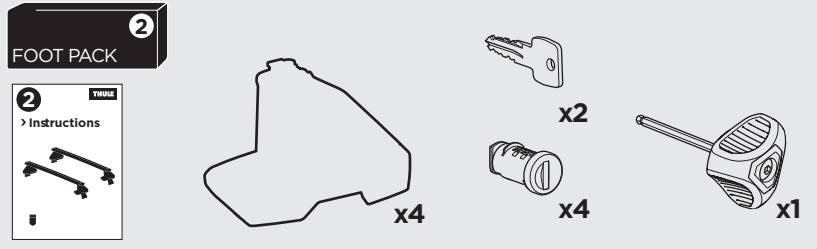
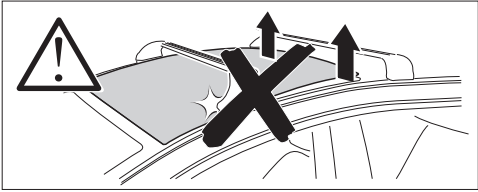
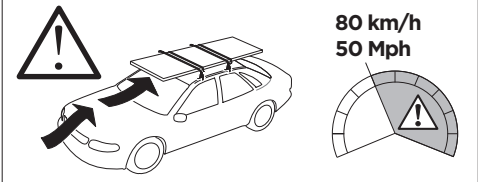
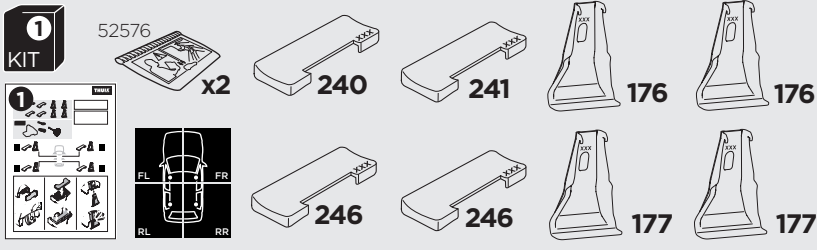



THULE WingBar Evo	THULE WingBar Edge	THULE WingBar	THULE SquareBar Evo	<b>Evo X (scale)</b>	<b>Edge X (scale)</b>
<b>VOLKSWAGEN Arteon, 5-dr Hatchback, 17-</b>				<b>47,5</b>	<b>B</b>

THULE ProBar Evo	THULE SlideBar Evo	<b>X (mm/inch)</b>		
<b>VOLKSWAGEN Arteon, 5-dr Hatchback, 17-</b>		<b>1126 mm / 44 3/8"</b>		

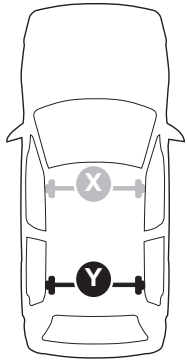

THULE WingBar Evo	THULE WingBar Edge	THULE WingBar	THULE SquareBar Evo	<b>Evo Y (scale)</b>	<b>Edge Y (scale)</b>
<b>VOLKSWAGEN Arteon, 5-dr Hatchback, 17-</b>				<b>44</b>	<b>I</b>

THULE ProBar Evo	THULE SlideBar Evo	<b>Y (mm/inch)</b>		
<b>VOLKSWAGEN Arteon, 5-dr Hatchback, 17-</b>		<b>1091 mm / 43"</b>		

	<b>W (mm/inch)</b>	<b>Z (mm/inch)</b>
<b>VOLKSWAGEN Arteon, 5-dr Hatchback, 17-</b>	<b>755 mm / 29 3/4"</b>	<b>150 mm / 5 7/8"</b>

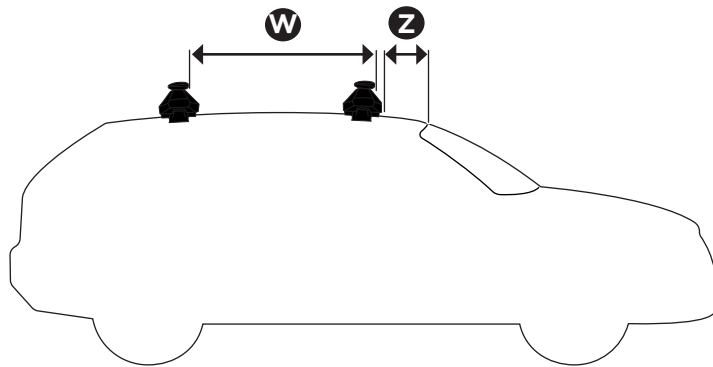

**i**

