



# KW-M180DBT KW-M180BT

MONITOR WITH RECEIVER

## Quick Start Guide

ÉCRAN AVEC RÉCEPTEUR

## Guide de démarrage rapide

MONITOR CON RECEPTOR

## Guía de inicio rápido

MONITOR COM RECETOR

## Guia de Iniciação Rápida

MONITOR MIT EMPFÄNGER

## Kurzanleitung

MONITOR MET ONTVANGER

## Snelstartgids

MONITOR CON RICEVITORE

## Guida rapida

ALICILI MONITÖR

## Hızlı Başlangıç Kılavuzu

JVCKENWOOD Corporation

### Model name indication position

See "Removing the trim plate" (P.14)

### Position d'indication du nom du modèle

Reportez-vous à la section « Retrait de la plaque de garniture » (P.31)

### Posición de la indicación del nombre del modelo

Consulte "Retirada del marco" (P.48)

### Posição da indicação do nome do modelo

Consulte "Retirar a moldura" (P.65)

### Anzeigeposition der Modellbezeichnung

Siehe „Entfernen der Ziertafel“ (S.82)

### Model naam indicatie positie

Zie "Verwijderen van de afwerkingsplaat" (P.99)

### Posizione di indicazione del nome del modello

Fare riferimento a "Rimozione della piastra di taglio" (P.116)

### Model adı konumu gösterir

Bkz. "Dekoratif Levhaların Sökülmesi" (S.133)

Trim plate  
Plaque de garniture  
Ziertafel  
Afwerkingsplaat  
Piastra di taglio  
Marco  
Moldura  
Dekoratif levha

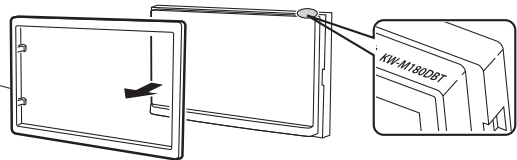

# Contents

Before use .....	2
How to read this manual .....	2
Precautions .....	2
Getting Started .....	3
Clock settings .....	3
Basics .....	4
Functions of the Buttons on the Front Panel .....	4
Common operations .....	4
HOME screen descriptions .....	4
Source control screen .....	4
Digital Radio .....	5
Digital Radio Basic Operation .....	5
Digital Radio Setup .....	5
Tuner .....	6
Tuner Basic Operation .....	6
Presetting stations .....	6
Tuner Setup .....	6
USB .....	7
Preparation .....	7
Playback operations .....	7
iPhone .....	8
Preparation .....	8
Playback operations .....	8
External Components .....	9
Using external audio/video players .....	9
Rear view camera .....	9
Learning function of steering remote .....	9
Reverse with ATT .....	9
Bluetooth .....	10
Register your smartphone to the unit .....	10
Receive a phone call .....	10
Make a phone call .....	10
Playing Bluetooth Audio Device .....	11
Controlling Audio .....	11
Controlling General Audio .....	11
Installation .....	12
Before Installation .....	12
Installing the unit .....	13
About this Unit .....	17
More information .....	17
Specifications .....	17
Copyrights .....	18

- For detailed operations and information, refer to the INSTRUCTION MANUAL on the following website:

<<https://www.jvc.net/cs/car/>>.



# Before use

## How to read this manual

- The panels shown in this guide are examples used to provide clear explanations of the operations. For this reason, they may be different from the actual panels.
- In operation procedures, bracket shape indicates the key or button you should control.  
< >: indicates the name of panel buttons.  
[ ]: indicates the name of touch keys

 This symbol on the product means there are important operating and maintenance instructions in this manual. Be sure to carefully read instructions in this manual.

## Precautions

### WARNING

#### To prevent injury or fire, take the following precautions:

- To prevent a short circuit, never put or leave any metallic objects (such as coins or metal tools) inside the unit.
- Do not watch or fix your eyes on the unit's display when you are driving for any extended period.
- If you experience problems during installation, consult your JVC dealer.

#### Precautions on using this unit

- When you purchase optional accessories, check with your JVC dealer to make sure that they work with your model and in your area.
- You can select a language to display menus, audio file tags, etc. See **General Settings Setup (P.3)**
- The Radio Data System or Radio Broadcast Data System feature won't work where the service is not supported by any broadcasting station.

#### Protecting the monitor

- To protect the monitor from damage, do not operate the monitor using a ballpoint pen or similar tool with the sharp tip.

#### Cleaning the Unit

If the front panel of this unit is stained, wipe it with a dry soft cloth such as a silicon cloth. If the front panel is stained badly, wipe the stain off with a cloth moistened with neutral cleaner, then wipe it again with a clean soft dry cloth.

### CAUTION

- Applying spray cleaner directly to the unit may affect its mechanical parts. Wiping the front panel with a hard cloth or using a volatile liquid such as thinner or alcohol may scratch the surface or erase screened print.

#### How to reset your unit

If the unit or the connected unit fails to operate properly, reset the unit.

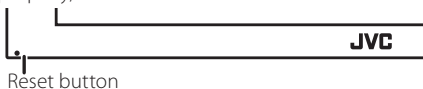

Reset button

# Getting Started

## 1 Turn the ignition key of your car to ACC.

The unit is turned on, please read the warning and press "Agree" to enter the screen.



## 2 Press the < Home > button.

## 3 Touch [Settings].

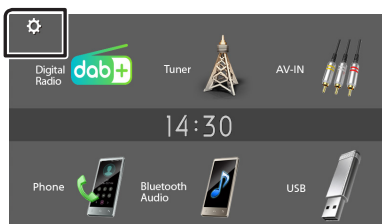

## 4 Touch the corresponding key and set the value.

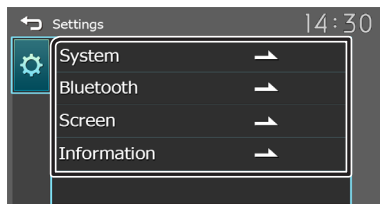

### [System]

#### [Beep Tone]

Activates or deactivates the key-touch tone. "ON" (Default), "OFF"

#### [Language]

Select the language used for the control screen and setting items. Default is "English".

#### [Time/Date]

Adjust the clock time. (P.3)

#### [Clock Mode]

Select the time display format. [12hr] / [24hr] (Default)

#### [Steering Remote]

Sets the desired function in the steering remote controller. See **Learning function of steering remote (P.9)**.

#### [Parking Guidelines]

You can display parking guidelines to enable easier parking when you shift the gear to the reverse (R) position. Default is "ON".

### [Guidelines SETUP]

If you select [ON] for [Parking Guidelines], you can adjust the parking guidelines.

### [Reverse with ATT (-20dB)]

When the gear is shifted to the reverse (R) position, the volume of the device is adjusted. Default is "ON". See **To adjust the Reverse with ATT (P.9)**.

### [System Reset]

Touch [System Reset] and then touch [YES] to set all the settings to the initial default settings.

### [Bluetooth]

Displays the Bluetooth Settings screen. (P.10)

### [Screen]

#### [Dimmer]

Select the dimmer mode. "High" (Default) / "Mid" / "Low"

#### [Demo]

Select the demonstration mode. Default is "ON".

### [Information]

Displays the software version and model number of this unit

## 5 Touch [Clock].

### Clock settings

#### ■ Synchronizing the clock time with FM RDS

Activate [RDS Clock Sync].

See **Tuner Setup (P.6)**.

#### ■ Adjusting the clock manually

##### 📎 NOTE

- Deactivate [RDS Clock Sync] before adjusting the clock.

### 1 Press the < Home > button.

### 2 Touch [Settings].

### 3 Touch [System].

### 4 Touch [Time/Date].

Clock screen appears.

### 5 Touch [▲] or [▼] to set the clock time.

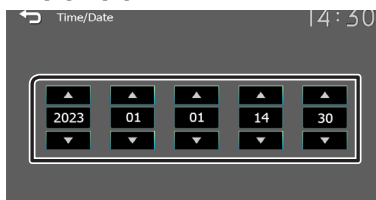

### 6 Touch [Clock].

# Basics

## Functions of the Buttons on the Front Panel

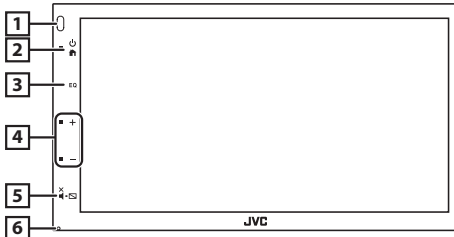

### 1 Remote Sensor

- Receives the remote control signal.

### 2 (HOME)

- Displays the HOME screen. **(P.4)**
- Press and hold turns the power off.
- When the power off, turns the power on.

### 3 EQ

- Displays the Audio screen.\* **(P.11)**
- \* The Audio screen is not displayed during SETUP screen or on the list screen etc.

### 4 +, - (Volume)

- Adjusts volume. The volume will go up until 15 when you keep pressing [ + ].

### 5 (MUTE, Display off)

- Mutes/restores the sound.
- Press and hold turns the screen off.
- When the screen is off, touch the display to turn on the screen.

### 6 Reset

- If the unit or the connected unit fails to operate properly, the unit returns to factory settings when this button is pressed.

## Common operations

### Turning on the power

- 1 Press the button.



### Turning off the power

- 1 Press and hold the button.

## HOME screen descriptions

- 1 Press the button.



HOME screen appears.



- 1 Clock display

Touch to displays the Clock screen.

- 2 Switch to the digital radio broadcast. **(P.5)**

\* *KW-M180DBT only*

- 3 Switches to the radio broadcast. **(P.6)**

- 4 Switches to an external component connected to the AV-IN input terminal. **(P.9)**

- 5 Displays the Hands Free screen. **(P.10)**

- 6 Plays a Bluetooth audio player. **(P.11)**

- 7 **[USB]**

Plays files on a USB device. **(P.7)**

**[iPhone]**

Plays an iPhone. **(P.8)**

- When iPhone is connected.

**[Mirroring]**

Displays the Mirroring screen.

- When android device with "Mirroring OB for JVC" application installed is connected.

- 8 Displays the SETUP screen. **(P.3)**

## Source control screen



- 1 : Returns to previous screen.

: Displays the Audio screen. **(P.11)**

# Digital Radio (KW-M180DBT)

## Digital Radio Basic Operation

- 1 Press the  button.
- 2 Touch [Digital Radio].

### Source control screen

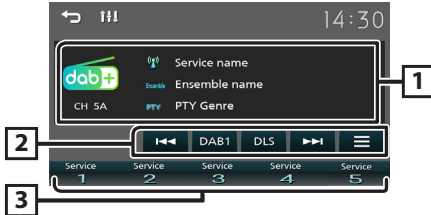

- 1 Displays the information of the current service:  
Service name, Ensemble name, PTY Genre, Channel
- 2 **[DAB]** : Switches the Digital Radio preset band. "DAB1", "DAB2", "DAB3"  
**[DLS]** : Display the Dynamic Label Segment screen  
**[<<] [>>]** : Select an ensemble, service, and component.  
**[≡]** : Displays the Digital Radio Setup screen. (P.5)
- 3 Recalls the memorized service.  
When touched for 2 seconds, stores the current receiving service in memory.

### Store a services

You can store the current receiving service in memory.

- 1 Tune in to a service you want to preset.
- 2 Touch and hold [#] (#:1-5) in which you want to store the service.

### Select a stored service

- 1 Touch [#] (#:1-5).

## Digital Radio Setup

- 1 Touch [].
- 2 Set each item as follows.

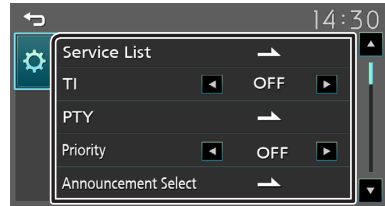

### [Service List]

Displays the Service List screen.

- [] : Touch and then touch [Yes] to find the latest service list.

### [TI]

Switches to the traffic information automatically when the traffic bulletin starts.  
"ON", "OFF" (Default)

### [PTY]

Searches for a program by program type.

### [Priority]

If the same service is provided by Radio Data System when reception of the service being provided by Digital Radio becomes poor, automatically switches to Radio Data System.  
"ON", "OFF" (Default)

### [Announcement Select]

Switches to the set Announcement service.

### [Related Service]

When you select ON, the unit switches to a related service (if exists) when a DAB service network is not available. Default is "OFF".

### [Antenna Power]

Sets power supply to the Digital Radio antenna. Set to "ON" when the Digital Radio antenna in use is equipped with a booster. Default is "ON".

- 3 Touch [].

# Tuner

## Tuner Basic Operation

- 1 Press the <img alt="Home button icon" data-bbox="175 105 195 125"/> button.
- 2 Touch [Tuner].

### Source control screen

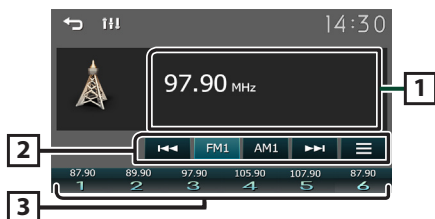

- 1 Displays the information of the current station:  
PS name, Frequency, PTY Genre, Indicator Items
- 2 **[FM]**: Switches the FM band.  
“FM1”, “FM2”, “FM3”  
**[AM]**: Switches the AM band.  
“AM1”, “AM2”  
**[<img alt="Left arrow" data-bbox="100 420 120 435"/> <img alt="Right arrow" data-bbox="140 420 160 435"/>]**: Tunes in a station with good reception automatically.  
**[<img alt="Menu icon" data-bbox="105 450 130 465"/>]**: Displays the Tuner Setup screen. **(P.6)**
- 3 Recalls the memorized station.  
When touched for 2 seconds, stores the current receiving station in memory.

## Presetting stations

### Auto memory

You can preset 6 stations for the current band (FM1/FM2/FM3/AM1/AM2).

- 1 Touch **[FM]** or **[AM]** to select the band.

- 2 Touch **[<img alt="Menu icon" data-bbox="145 670 170 685"/>]**.

- 3 Touch **[Auto Store]**.

The local stations with the strongest signals are found and stored automatically.

### Manual memory

You can store the current receiving station in memory.

- 1 Tune in to a station you want to preset.
- 2 Touch and hold **[#]** (#:1-6) in which you want to store the station.

### Recalling the preset station

- 1 Touch **[#]** (#:1-6).

## Tuner Setup

- 1 Touch **[<img alt="Menu icon" data-bbox="595 105 620 125"/>]**.
- 2 Set each item as follows.

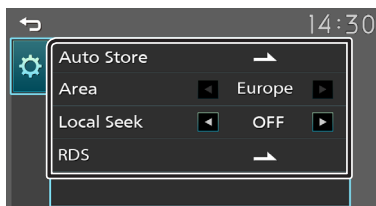

### **[Auto Store]**

Automatically searches and stores the 6 stations with the strongest signals for the selected band.  
“Auto Store” appears.

### **[Area]**

“Europe”: AM/FM intervals: 9 kHz/50 kHz.

### **[Local Seek]**

Tunes in **only** to the stations with sufficient signal strength. (**LOC** indicator lights up.)  
“ON”, “OFF” (Default)

### **[RDS] \*1**

Displays the RDS Settings screen.

### **[AF]**

When station reception is poor, automatically switches to the station that is broadcasting the same program over the same Radio Data System network.  
“ON” (Default), “OFF”

### **[TA]**

Switches to the traffic information automatically when the traffic bulletin starts. (**TI** indicator lights up.)  
“ON”, “OFF” (Default)

### **[RDS Clock Sync]**

Synchronizing the Radio Data System station time data and this unit’s clock.  
“ON” (Default), “OFF”

### **[PTY]**

Select a program type.

### **[PTY Seek]**

Searches for a program by program type.

\*1 FM only

- 3 Touch **[<img alt="Home button icon" data-bbox="595 875 620 895"/>]**.

# USB

## Preparation

### ■ Connecting a USB device

- 1 Remove the cap of the USB terminal.
- 2 Connect the USB device with the USB cable.

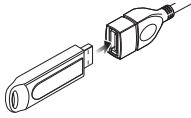

The unit reads the device and playback starts.

### ■ To disconnect the USB device:

- 1 Press the <Home> button.
- 2 Touch a source other than [USB].
- 3 Detach the USB device.

### ■ Usable USB device

This unit can play MPEG1/ MPEG2/ MPEG4/H.264/ MKV/ MP3/WMA/ AAC/ WAV/ FLAC/ OGG files stored in a USB mass storage class device. (P.17)

## Playback operations

### ■ Control the music you are listening to on the source control screen.

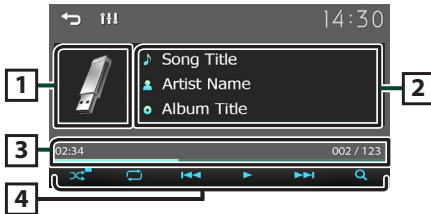

- 1 The jacket of the currently playing file is displayed.
- 2 Displays the information of the current file.
- 3 Playing time/File number  
**Play time bar** : For confirmation of current playing position.
- 4 [⏮]: Selects Random playback mode.  
[⏪]: Selects Repeat playback mode.  
[⏸], [⏹]: Plays or pauses.  
[⏮], [⏭]: Searches the previous/next content.  
Touch and hold to fast forward or fast backward.  
[Q]: Searches file. (P.7)

### ■ For Video playback

- 1 When the operation buttons are not displayed on the screen, touch the display.

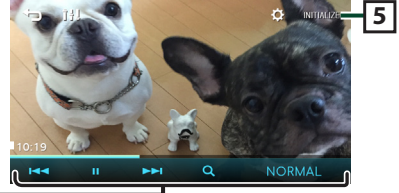

- 5 [⚙️]: You can adjust image quality in video screen.  
[INITIALIZE]: To clear the adjustment.
- 6 [▶], [⏸]: Plays or pauses.  
[⏮], [⏭]: Searches the previous/next content.  
Touch and hold to fast forward or fast backward.  
[Q]: Searches file. (P.7)  
[NORMAL]/[16:9]/[4:3]: Select a screen mode.

### ■ Selecting a track in a list (Searches file)

- 1 Touch [Q].
- 2 Select whether you search by audio files [🎵], video files [🎬].

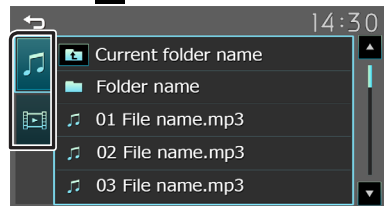

- 3 Touch [🏠] to moves to the upper hierarchy.
  - 4 Touch the desired folder.  
When you touch a folder its contents are displayed.
    - Touch [🏠] to moves to the upper hierarchy.
  - 5 Touch desired item from the content list.  
Playback starts.
- 📌 NOTE
- The source control screen appears when you touch [🏠] at the top hierarchy.

# iPhone

## Preparation

### Connecting iPhone

- For details about connecting iPhone, see page 16.

#### 1 Remove the cap of the USB terminal.

#### 2 Connect the iPhone.

The unit reads the device and playback starts.

### To disconnect the iPhone

#### 1 Press the <Home> button.

#### 2 Touch a source other than [iPhone].

#### 3 Detach the iPhone.

### Connectable iPhone

The following models can be connected to this unit.

Made for

- iPhone 14 Pro Max
- iPhone 14 Pro
- iPhone 14 Plus
- iPhone 14
- iPhone 13 Pro Max
- iPhone 13 Pro
- iPhone 13
- iPhone 13 mini
- iPhone 12 Pro Max
- iPhone 12 Pro
- iPhone 12
- iPhone 12 mini
- iPhone SE (2nd generation)
- iPhone 11 Pro Max
- iPhone 11 Pro
- iPhone 11
- iPhone XS Max
- iPhone XS
- iPhone XR
- iPhone X
- iPhone 8 Plus
- iPhone 8
- iPhone 7 Plus
- iPhone 7
- iPhone SE
- iPhone 6s Plus
- iPhone 6s

#### NOTE

- If you start playback after connecting the iPhone, the music that has been played by the iPhone is played first.
- Cap the USB terminal whenever not using.

## Playback operations

### Control the music you are listening to on the source control screen.

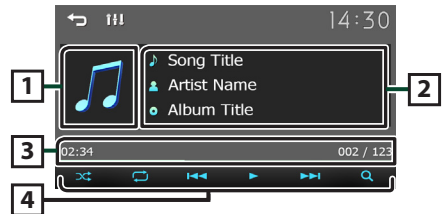

1 Artwork (Shown if the track contains artwork)

2 Displays the information of the current file.

3 Playing time/File number  
**Play time bar** : For confirmation of current playing position.

4 [⏮] : Selects Random playback mode.

[⏪] : Selects Repeat playback mode.

[⏸], [⏹] : Plays or pauses.

[⏮], [⏭] : Searches the previous/next content.

Touch and hold to fast forward or fast backward.

[⏹] : Searches content. **(P.8)**

### Selecting a content in a list

#### 1 Touch [Q].

#### 2 Touch desired item.

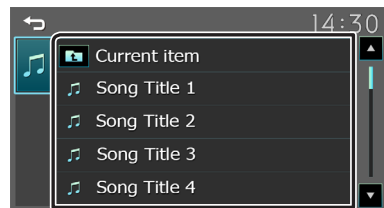

When you touch a category its contents are displayed.

#### 3 Touch desired item from the content list.

Playback starts.

- Touch [⏮] to moves to the upper hierarchy.

#### NOTE

- The source control screen appears when you touch [⏮] at the top hierarchy.



# External Components

## Using external audio/video players

### Starting playback

- 1 Connect an external component to the AV-IN input terminal. (P.15)
- 2 Press the <Home> button.
- 3 Touch [AV-IN].
- 4 Turn on the connected component and start playing the source.

### For Video playback

- 1 When the operation buttons are not displayed on the screen, touch the display.

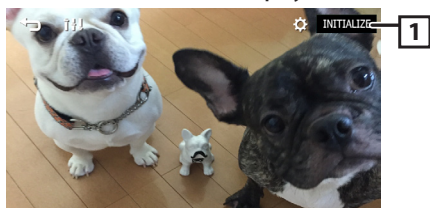

- 1 [Gear icon]: You can adjust image quality in video screen.

[INITIALIZE]: To clear the adjustment.

### NOTE

- When the picture from the rear view camera is displayed on the AV-IN screen, the picture output from the Visual Output terminal disappears.

## Rear view camera

To use a rear view camera, the REVERSE lead connection is required. For connecting a rear view camera. (P.15)

### Displaying the picture from the rear view camera

The rear view screen is displayed when you shift the gear to the reverse (R) position.



- The first touch removes the Caution, and the second touch closes the Camera Screen.

## Learning function of steering remote

This function is available only when your vehicle is equipped with the electrical steering remote controller.

- 1 Press the <Home> button.
- 2 Touch [Settings].
- 3 Touch [System].
- 4 Touch [Steering Remote].
- 5 Touch the function you want to set.
- 6 Press and hold the steering remote controller button.

### NOTE

- You can have the unit learned all buttons at a time. In that case, press the all buttons one at a time and after pressing all of them, touch [↵] in Steering Remote Controller Setting screen.

- 7 Repeat steps 5 and 6 as necessary.

- 8 Touch [↵].

### NOTE

- Touch [Initialize] and then touch [Yes] to set all the settings to the initial default settings.

## Reverse with ATT (-20dB)

When the gear is shifted to the reverse (R) position, the volume of the device is adjusted.

- 1 Press the <Home> button.
- 2 Touch [Settings].
- 3 Touch [System].
- 4 Touch [Reverse with ATT].
- 5 Touch [◀] or [▶] set to [ON]/[OFF].

### NOTE

- The setting value is ON (default)

# Bluetooth

## Register your smartphone to the unit

You can use your Bluetooth smartphone when paired to this unit.

- 1 Turn on the Bluetooth function on your smartphone/cell-phone.
- 2 Search the unit ("KW-M180DBT"/"KW-M180BT") from your smartphone/cell-phone.

If a PIN code is required, enter the PIN code ("0000").

-  appears when the Bluetooth smartphone is connected.

### Disconnecting the device

- Turn off the Bluetooth function from your smartphone/cell-phone.
- Turn off the ignition switch.

## Receive a phone call



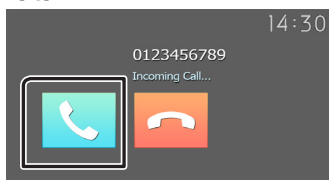

- 1 Touch .

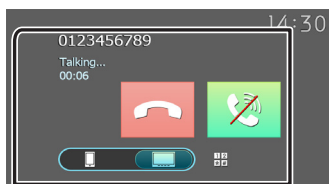

- : Reject an incoming call.

### Operations during a call



-  Ending a call
-  Mute your voice
-  You can send tones by touching desired keys on the screen.
  - Touch  to close the window.
-  Switches the speaking voice output between smartphone/cell-phone and speaker.

- **Adjust the receiver volume**  
Press the <+> or <-> button.

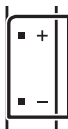



## Make a phone call

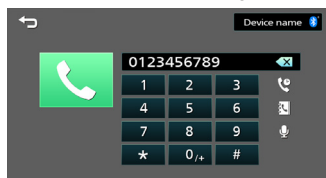



- 1 Press the  button.
- 2 Touch [Phone].
- 3 See the table below for each operation method.





### Call by entering a phone number

- 1) Enter a phone number with number keys.
  - 2) Touch .
- Make a call
- Touch  to delete the last entry.

### Call using call records





- 1) Touch .
- 2) Touch  (Incoming Calls),  (Outgoing Calls),  (Missed Calls).
- 3) Select the phone number from the list.  
Make a call

### Call using the phonebook

- 1) Touch .
- 2) Select the name from the list.  
Make a call
  - : Updates the phonebook. Touch this button after you have made a change to the phonebook of your smartphone/cell-phone.

### Call Waiting

When you receive a new call while talking on the phone:

- 1) Touch , the current call is put on hold and you can answer the newly received call.
- 2) Each time you touch , the caller will change to the other one.
- 3) If you touch  during call waiting, reject an incoming call.
- 4) If you touch , when someone is on hold, the current call will end to be switched to the call waiting on hold.
- 5) Touch  mute your voice

## Bluetooth

### Playing Bluetooth Audio Device

- 1 Press the <Home> button.
- 2 Touch [Bluetooth Audio].

#### Source control screen

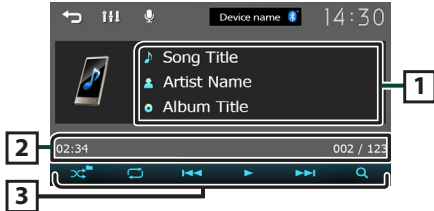

- 1 Displays the information of the current file.
- 2 Playing time/File number  
Play time bar : For confirmation of current playing position.
- 3 [ ] : Selects Random playback mode.  
[ ] : Selects Repeat playback mode.  
[▶], [⏸] : Plays or pauses.  
[◀], [▶] : Searches the previous/next content.  
Touch and hold to fast forward or fast backward.  
[Q] : Searches file. (P.11)

#### NOTE

- Operations and display indications may differ according to their availability on the connected device.

#### Selecting a content in a list

- 1 Touch [Q].
- 2 Touch desired item.  
When you touch a category its contents are displayed.
- 3 Touch desired item from the content list.  
Playback starts.
  - Touch [↶] to moves to the upper hierarchy.

#### NOTE

- The source control screen appears when you touch [↶] at the top hierarchy.

## Controlling Audio

You can adjust various settings such as audio balance or subwoofer level.

- 1 Press the <EQ> button.
- 2 See the below for each operation method.

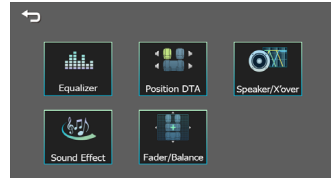

### Controlling General Audio

- 1 Press the <EQ> button.
- 2 Touch [Fader / Balance].
- 3 Set each item as follows.

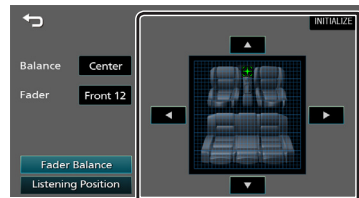

#### [Fader Balance]

**Balance** Adjust the left and right volume balance.  
[◀] [▶]

15 (left) to 15 (right)

**Fader** Adjust the front and rear volume balance.  
[▲] [▼]

15 (front) to 15 (rear)

[INITIALIZE] To clear the adjustment.

#### [Listening Position]

[●] Select a listening position from "Front Left", "Front All", "Front Right", and "Middle".

[INITIALIZE] To clear the adjustment.

# Installation

## Before Installation

Before installation of this unit, please note the following precautions.

### ▲WARNINGS

- If you connect the ignition wire (red) and the battery wire (yellow) to the car chassis (ground), you may cause a short circuit, that in turn may start a fire. Always connect those wires to the power source running through the fuse box.
- Do not cut out the fuse from the ignition wire (red) and the battery wire (yellow). The power supply must be connected to the wires via the fuse.

### ▲CAUTION

- Install this unit in the console of your vehicle. Do not touch the metal part of this unit during and shortly after the use of the unit. Metal part such as the heat sink and enclosure become hot.

### NOTE

- Mounting and wiring this product requires skills and experience. For best safety, leave the mounting and wiring work to professionals.
- Make sure to ground the unit to a negative 12V DC power supply.
- Do not install the unit in a spot exposed to direct sunlight or excessive heat or humidity. Also avoid places with too much dust or the possibility of water splashing.
- If your car's ignition does not have an ACC position, connect the ignition wires to a power source that can be turned on and off with the ignition key. If you connect the ignition wire to a power source with a constant voltage supply, such as with battery wires, the battery may be drained.
- If the console has a lid, make sure to install the unit so that the front panel will not hit the lid when closing and opening.
- If the fuse blows, first make sure the wires aren't touching to cause a short circuit, then replace the old fuse with one with the same rating.
- Insulate unconnected wires with vinyl tape or other similar material. To prevent a short circuit, do not remove the caps on the ends of the unconnected wires or the terminals.
- Secure the wires with cable clamps and wrap vinyl tape around the wires that comes into contact with metal parts to protect the wires and to prevent short circuit.
- Connect the speaker wires correctly to the terminals to which they correspond. The unit may be damaged or fail to work if you share the ⊖ wires or ground them to any metal part in the car.

- When only two speakers are being connected to the system, connect the connectors either to both the front output terminals or to both the rear output terminals (do not mix front and rear). For example, if you connect the ⊕ connector of the left speaker to a front output terminal, do not connect the ⊖ connector to a rear output terminal.
- After the unit is installed, check whether the brake lamps, blinkers, wipers, etc. on the car are working properly.
- Mount the unit so that the mounting angle is 30° or less.
- Do not press hard on the panel surface when installing the unit to the vehicle. Otherwise scars, damage, or failure may result.
- Reception may drop if there are metal objects near the Bluetooth antenna.



# Installation

## Supplied accessories for installation

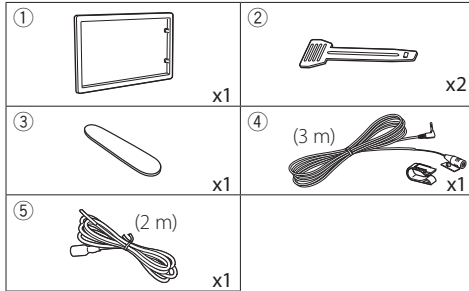

## Installation procedure

- 1) To prevent a short circuit, remove the key from the ignition and disconnect the  $\ominus$  terminal of the battery.
- 2) Make the proper input and output wire connections for each unit.
- 3) Connect the wire on the wiring harness.
- 4) Take Connector B on the wiring harness and connect it to the speaker connector in your vehicle.
- 5) Take Connector A on the wiring harness and connect it to the external power connector on your vehicle.
- 6) Connect the wiring harness connector to the unit.
- 7) Install the unit in your car.
- 8) Reconnect the  $\ominus$  terminal of the battery.
- 9) Press the reset button.

## Installing the unit

### Non-Japanese cars

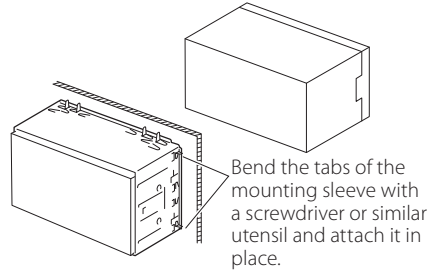

### NOTE

- Make sure that the unit is installed securely in place. If the unit is unstable, it may malfunction (eg, the sound may skip).

### Trim plate

- 1) Attach accessory ① to the unit.

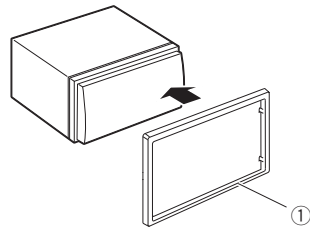

# Installation

## Microphone unit

- 1) Check the installation position of the microphone (accessory ④).
- 2) Clean the installation surface.
- 3) Remove the separator of the microphone (accessory ④), and stick the microphone to the place shown below.
- 4) Wire the microphone cable up to the unit with it secured at several positions using tape or other desired method.
- 5) Adjust the direction of the microphone (accessory ④) to the driver.

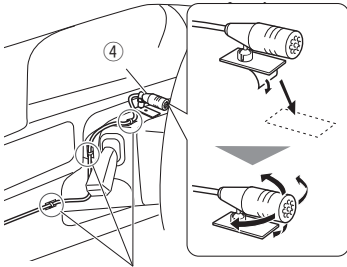

Fix a cable with a commercial item of tape.

### NOTE

- Swap the clips if necessary.

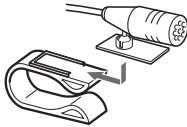

## Removing the trim plate

- 1) Use the extraction key (accessory ③) to lever out the four tabs (two on the left part, two on the right part).

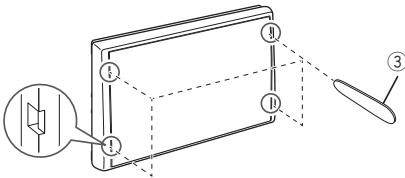

- 2) Pull the trim plate forward.

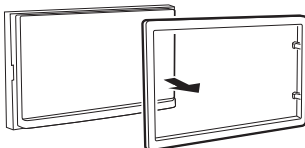

## Removing the unit

- 1) Remove the trim plate by referring to step 1 in "Removing the trim plate".
- 2) Insert the extraction key (accessory ②) deeply into the slot as shown. (The protrusion at the tip of the extraction key must face toward the unit.)

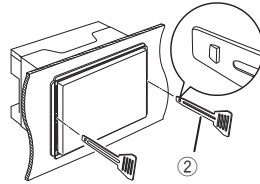

- 3) With the inserted extraction key secured, insert the other extraction key into the slot.

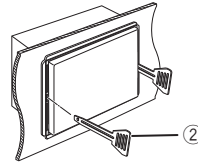

- 4) Pull out the unit halfway.

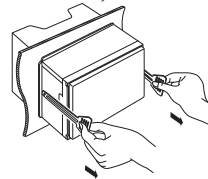

### NOTE

- Be careful to avoid injury from the catch pins on the extraction key.
- 5) Pull the unit all the way out with your hands, being careful not to drop it.

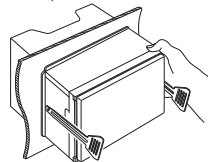

# Installation

## Connecting wires to terminals

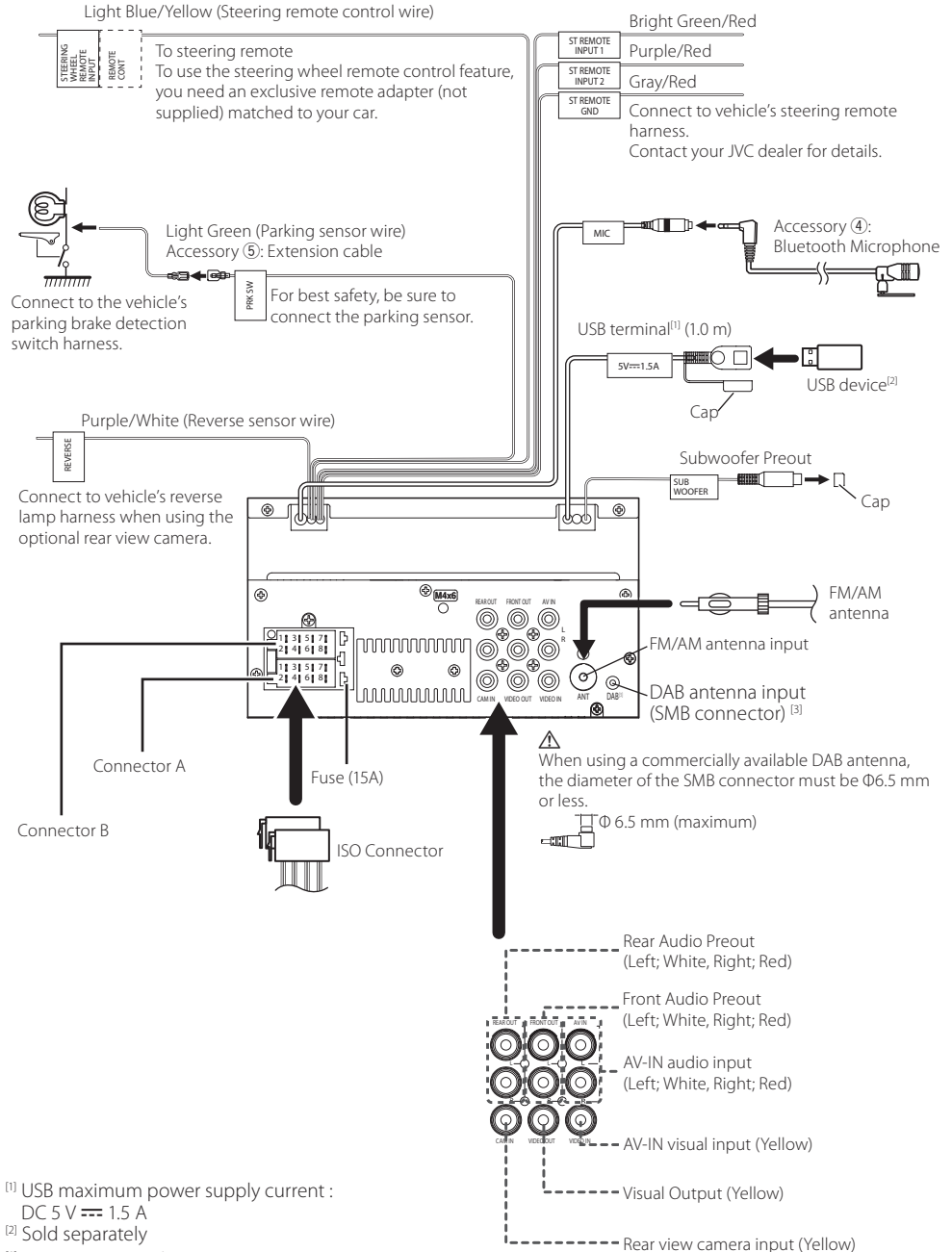

<sup>[1]</sup> USB maximum power supply current :  
DC 5 V  $\approx$  1.5 A

<sup>[2]</sup> Sold separately

<sup>[3]</sup> KW-M180DBT only

# Installation

## ■ Wiring harness connector function guide

Pin	Color and function	
A-4	Yellow	Battery
A-5	Blue/White <sup>[1]</sup>	Power Control
A-7	Red	Ignition (ACC)
A-8	Black	Earth (Ground) Connection
B-1/ B-2	Purple (+) / Purple/Black (-)	Rear Right
B-3/ B-4	Gray (+) / Gray/Black (-)	Front Right
B-5/ B-6	White (+) / White/Black (-)	Front Left
B-7/ B-8	Green (+) / Green/Black (-)	Rear Left

<sup>[1]</sup> Max. 150mA, 12V

- Speaker Impedance: 4-8 Ω

### ⚠ CAUTION

Before you connect the commercially available ISO connectors to the unit, check the following condition:

- Make sure that the pin assignment of the connector matches with the JVC unit.
- Take extra notice of the power wire.
- In case battery wire and ignition wire are not corresponding then change them accordingly.
- In case the car does not have an ignition wire, use a commercially available interface.

## ■ Connecting an iPhone/Android

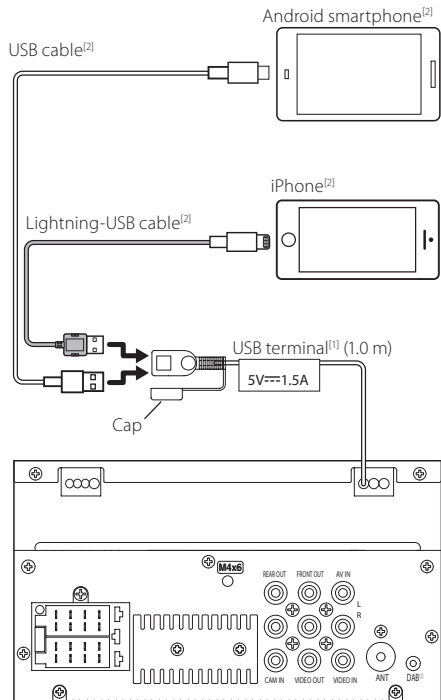

<sup>[1]</sup> USB maximum power supply current :  
DC 5 V --- 1.5 A

<sup>[2]</sup> Sold separately

<sup>[3]</sup> KW-M180DBT only



# About this Unit

## More information

### Usable USB device

This unit can play MPEG1/ MPEG2/ MPEG4/H.264/ MKV/ MP3/WMA/ AAC/ WAV/ FLAC/ OGG files stored in a USB mass storage class device.

- File system: FAT16 / FAT32 / NTFS / exFAT
- This unit can recognize a total of 9,999 files and 320 folders (a maximum of 9,999 files per folder).
- The maximum number of characters:
  - Folder names : 70 characters
  - File names : 70 characters
  - Tag : 70 characters

### NOTE

- When the USB device is connected to this unit, it can be charged through the USB cable.
- Install the USB device in the place where it will not affect safe driving.
- You cannot connect a USB device via a USB hub and Multi Card Reader.
- Take backups of the audio files used with this unit. The files may be erased depending on the operating conditions of the USB device. We shall have no compensation for any damage arising from any erased data.
- No USB device comes with this unit. You need to purchase a commercially available USB device.
- Cap the USB terminal whenever not using.

### Playable Audio files

Audio format	Bit rate/ (Bit count)	Sampling frequency
MP3 (.mp3)	16 – 320kbps, VBR	16 – 48 kHz
WMA (.wma)	16 – 320kbps	16 – 48 kHz
AAC-LC (.m4a)	16 – 320kbps	16 – 48 kHz
Linear PCM (WAVE) (.wav)	(16/24 bit)	8 – 192 kHz
FLAC (.flac)	(16/24 bit)	8 – 192 kHz
Vorbis (.ogg)	(16/24 bit)	8 – 192 kHz

- This unit can show ID3 Tag Version 1.0/1.1/2.2/2.3/2.4 (for MP3).

### NOTE

- WMA and AAC of which is covered with DRM cannot be played.
- Although the audio files are complied with the standards listed above, the play may be impossible depending on the types or conditions of media or device.

### Acceptable Video files

Video format	Video codec	Audio codec
MPEG-1 (.mpg, .mpeg)	MPEG-1	MPEG Audio Layer 2
MPEG-2 (.mpg, .mpeg)	MPEG-2	MPEG Audio Layer 2
MPEG-4 (.mp4, .avi)	MPEG-4 (SP,ASP)	MP3, AAC-LC (2ch)
H.264/MPEG-4 AVC (.mp4, .mkv, .avi, .flv, .f4v)	H.264/MPG-4 AVC (BP/MP/HP)	MP3, AAC (2ch)
MKV (.mkv)	Video Format follows H.264/ MPEG-4 AVC, MPEG4, XVID	MP3, AAC, Vorbis, FLAC

## Specifications

### Bluetooth section

#### Frequency

: 2.4 – 2.48 GHz

#### RF Output Power (E.I.R.P.)

: +8dBm (MAX)

### Audio section

#### Speaker Impedance

: 4 – 8 Ω

### General

#### Operating Voltage

: 12V DC car battery

## About this Unit

### Copyrights

- The Bluetooth® word mark and logos are registered trademarks owned by the Bluetooth SIG, Inc. and any use of such marks by JVCKENWOOD Corporation is under license. Other trademarks and trade names are those of their respective owners.
- Use of the Made for Apple badge means that an accessory has been designed to connect specifically to the Apple product(s) identified in the badge and has been certified by the developer to meet Apple performance standards. Apple is not responsible for the operation of this device or its compliance with safety and regulatory standards. Please note that the use of this accessory with an Apple product may affect wireless performance.
- Apple, iPhone and Lightning are trademarks of Apple Inc., registered in the U.S. and other countries.
- Android is a trademark of Google LLC.
- Microsoft and Windows Media are either registered trademarks or trademarks of Microsoft Corporation in the United States and/or other countries.
- THIS PRODUCT IS LICENSED UNDER THE MPEG-4 VISUAL PATENT PORTFOLIO LICENSE FOR THE PERSONAL AND NON-COMMERCIAL USE OF A CONSUMER FOR (i) ENCODING VIDEO IN COMPLIANCE WITH THE MPEG-4 VISUAL STANDARD ("MPEG-4 VIDEO") AND/OR (ii) DECODING MPEG-4 VIDEO THAT WAS ENCODED BY A CONSUMER ENGAGED IN A PERSONAL AND NON-COMMERCIAL ACTIVITY AND/OR WAS OBTAINED FROM A VIDEO PROVIDER LICENSED BY MPEG LA TO PROVIDE MPEG-4 VIDEO. NO LICENSE IS GRANTED OR SHALL BE IMPLIED FOR ANY OTHER USE. ADDITIONAL INFORMATION INCLUDING THAT RELATING TO PROMOTIONAL, INTERNAL AND COMMERCIAL USES AND LICENSING MAY BE OBTAINED FROM MPEG LA, LLC. SEE [HTTP://WWW.MPEGLA.COM](http://www.mpegla.com).
- THIS PRODUCT IS LICENSED UNDER THE AVC PATENT PORTFOLIO LICENSE FOR THE PERSONAL USE OF A CONSUMER OR OTHER USES IN WHICH IT DOES NOT RECEIVE REMUNERATION TO (i) ENCODE VIDEO IN COMPLIANCE WITH THE AVC STANDARD ("AVC VIDEO") AND/OR (ii) DECODE AVC VIDEO THAT WAS ENCODED BY A CONSUMER ENGAGED IN A PERSONAL ACTIVITY AND/OR WAS OBTAINED FROM A VIDEO PROVIDER LICENSED TO PROVIDE AVC VIDEO. NO LICENSE IS GRANTED OR SHALL BE IMPLIED FOR ANY OTHER USE. ADDITIONAL INFORMATION MAY BE OBTAINED FROM MPEG LA, L.L.C. SEE [HTTP://WWW.MPEGLA.COM](http://www.mpegla.com)
- libFLAC  
Copyright (C) 2000-2009 Josh Coalson  
Copyright (C) 2011-2013 Xiph.Org Foundation
  - Redistribution and use in source and binary forms, with or without modification, are permitted provided that the following conditions are met:
  - Redistributions of source code must retain the above copyright notice, this list of conditions and the following disclaimer.
- Redistributions in binary form must reproduce the above copyright notice, this list of conditions and the following disclaimer in the documentation and/or other materials provided with the distribution.  
Neither the name of the Xiph.org Foundation nor the names of its contributors may be used to endorse or promote products derived from this software without specific prior written permission.  
THIS SOFTWARE IS PROVIDED BY THE COPYRIGHT HOLDERS AND CONTRIBUTORS "AS IS" AND ANY EXPRESS OR IMPLIED WARRANTIES, INCLUDING, BUT NOT LIMITED TO, THE IMPLIED WARRANTIES OF MERCHANTABILITY AND FITNESS FOR A PARTICULAR PURPOSE ARE DISCLAIMED. IN NO EVENT SHALL THE FOUNDATION OR CONTRIBUTORS BE LIABLE FOR ANY DIRECT, INDIRECT, INCIDENTAL, SPECIAL, EXEMPLARY, OR CONSEQUENTIAL DAMAGES (INCLUDING, BUT NOT LIMITED TO, PROCUREMENT OF SUBSTITUTE GOODS OR SERVICES; LOSS OF USE, DATA, OR PROFITS; OR BUSINESS INTERRUPTION) HOWEVER CAUSED AND ON ANY THEORY OF LIABILITY, WHETHER IN CONTRACT, STRICT LIABILITY, OR TORT (INCLUDING NEGLIGENCE OR OTHERWISE) ARISING IN ANY WAY OUT OF THE USE OF THIS SOFTWARE, EVEN IF ADVISED OF THE POSSIBILITY OF SUCH DAMAGE.
- libogg  
Copyright (c) 2002, Xiph.org Foundation  
Redistribution and use in source and binary forms, with or without modification, are permitted provided that the following conditions are met:
  - Redistributions of source code must retain the above copyright notice, this list of conditions and the following disclaimer.
  - Redistributions in binary form must reproduce the above copyright notice, this list of conditions and the following disclaimer in the documentation and/or other materials provided with the distribution.
  - Neither the name of the Xiph.org Foundation nor the names of its contributors may be used to endorse or promote products derived from this software without specific prior written permission.THIS SOFTWARE IS PROVIDED BY THE COPYRIGHT HOLDERS AND CONTRIBUTORS "AS IS" AND ANY EXPRESS OR IMPLIED WARRANTIES, INCLUDING, BUT NOT LIMITED TO, THE IMPLIED WARRANTIES OF MERCHANTABILITY AND FITNESS FOR A PARTICULAR PURPOSE ARE DISCLAIMED. IN NO EVENT SHALL THE FOUNDATION OR CONTRIBUTORS BE LIABLE FOR ANY DIRECT, INDIRECT, INCIDENTAL, SPECIAL, EXEMPLARY, OR CONSEQUENTIAL DAMAGES (INCLUDING, BUT NOT LIMITED TO, PROCUREMENT OF SUBSTITUTE GOODS OR SERVICES; LOSS OF USE, DATA, OR PROFITS; OR BUSINESS INTERRUPTION) HOWEVER CAUSED AND ON ANY THEORY OF LIABILITY, WHETHER IN CONTRACT, STRICT LIABILITY, OR TORT (INCLUDING NEGLIGENCE OR OTHERWISE) ARISING IN ANY WAY OUT OF THE USE OF THIS SOFTWARE, EVEN IF ADVISED OF THE POSSIBILITY OF SUCH DAMAGE.

# Table des matières

Avant l'utilisation .....	19
Comment lire ce manuel .....	19
Précautions .....	19
Mise en route .....	20
Paramètres de l'horloge .....	20
Les bases .....	21
Fonctions des boutons en façade .....	21
Opérations courantes .....	21
Accueil description de l'écran .....	21
Écran de commande de source .....	21
Radio numérique .....	22
Utilisation de base de la radio numérique .....	22
Configuration de la radio numérique .....	22
Tuner .....	23
Utilisation de base de la tuner .....	23
Présélectionner des stations .....	23
Configuration tuner .....	23
USB .....	24
Préparation .....	24
Options de lecture .....	24
iPhone .....	25
Préparation .....	25
Options de lecture .....	25
Composants Externes .....	26
Utilisant des lecteurs audio/vidéo externes .....	26
Caméra de recul .....	26
Fonction d'apprentissage de la télécommande de direction .....	26
Inverse avec ATT .....	26
Bluetooth .....	27
Enregistrer votre smartphone dans l'appareil .....	27
Recevoir un appel .....	27
Passer un appel .....	27
Utilisation d'un appareil audio Bluetooth en lecture .....	28
Contrôle de l'audio .....	28
Contrôle de l'audio en général .....	28
Installation .....	29
Avant l'installation .....	29
Installation de l'appareil .....	30
À propos de cet appareil .....	34
Plus d'informations .....	34
Spécifications .....	34
Copyrights .....	35

- En ce qui concerne les opérations et les informations détaillées, se reporter au MODE D'EMPLOI sur le site Web suivant:

<<https://www.jvc.net/cs/car/>>



# Avant l'utilisation

## Comment lire ce manuel

- Les écrans illustrés dans le présent guide sont des exemples destinés à fournir des explications plus claires des opérations. Pour cette raison, il peut arriver qu'ils soient différents de ceux rencontrés dans la réalité.
- Dans les procédures opérationnelles, le crochet indique la touche ou le bouton à activer.  
< >: indique le nom des boutons de la façade.  
[ ]: indique le nom des touches tactiles.

 Ce symbole sur le produit indique qu'il y a des instructions de fonctionnement et d'entretien importantes dans ce manuel. Assurez-vous de lire attentivement les instructions de ce manuel.

## Précautions

### AVERTISSEMENT

#### Pour éviter toute blessure ou incendie, prenez les précautions suivantes :

- Pour éviter un court-circuit, ne mettez ni ne laissez jamais d'objets métalliques (comme des pièces de monnaie ou des outils en métal) à l'intérieur de l'appareil.
- Ne regardez pas ni ne fixez votre regard sur l'affichage de l'appareil trop longtemps pendant la conduite.
- Si vous rencontrez des problèmes pendant l'installation, consultez votre revendeur JVC.

#### Précautions d'utilisation de l'appareil

- Lorsque vous achetez des accessoires en option, vérifiez auprès de votre revendeur JVC qu'ils fonctionneront avec votre modèle et dans votre région.
- Vous pouvez sélectionner une langue pour afficher les menus, les étiquettes de fichiers audio, et autres. Voir **Mise en route (P.20)**
- Les fonctions Radio Data System ou Radio Broadcast Data System sont inopérantes dans les zones où le service n'est pris en charge par aucune station de radiodiffusion.

#### Protection du moniteur

- Ne touchez pas le moniteur avec un stylo à bille ou tout autre outil pointu. Cela pourrait l'endommager.

#### Nettoyage de l'appareil

Si la façade de l'appareil est tachée, essuyez-la avec un chiffon doux et sec, tel qu'un chiffon siliciné. Si la façade est très sale, essuyez-la avec un chiffon imbibé d'un produit de nettoyage neutre, puis essuyez-la à nouveau avec un chiffon doux et sec propre.

### ATTENTION

- La pulvérisation directe de produit de nettoyage sur l'appareil risque d'endommager les pièces mécaniques. Si vous nettoyez la façade avec un chiffon trop rugueux ou un liquide volatil, comme un solvant ou de l'alcool, vous risquez d'en rayer la surface ou d'effacer les caractères sérigraphiés.

#### Comment réinitialiser votre appareil

Si l'appareil ou l'équipement qui lui est branché ne fonctionne pas normalement, réinitialisez-le.



# Mise en route

## 1 Tournez la clé de contact de votre véhicule sur la position ACC.

L'appareil se met en marche. Veuillez lire l'avertissement et appuyer sur "Agree" pour entrer dans l'écran .



## 2 Appuyez sur le bouton < 🏠 > .

## 3 Touchez [Settings].

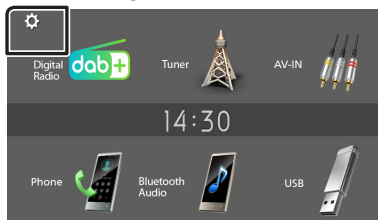

## 4 Effleurez la touche correspondante, puis définissez la valeur.

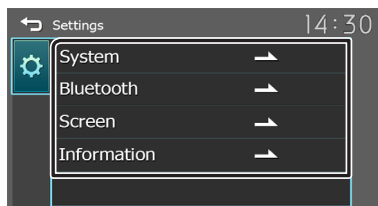

### [System]

#### [Beep Tone]

Active ou désactive la touche ton. « ON » (marche) (par défaut), « OFF » (arrêt)

#### [Language]

Sélectionne la langue utilisée sur l'écran de commande et sur les éléments de configuration. La langue sélectionnée par défaut est « English » (anglais).

#### [Time/Date]

Réglez l'heure de l'horloge. (P.20)

#### [Clock Mode]

Sélectionnez le format d'affichage de l'heure. [12hr] / [24hr] (par défaut)

#### [Steering Remote]

Configure la fonction souhaitée dans la commande au volant. Voir **Fonction d'apprentissage de la télécommande de direction (P.26)**.

#### [Parking Guidelines]

Vous pouvez afficher les directives de stationnement pour faciliter le stationnement lorsque vous changez le rapport dans la position marche arrière (AR). Le choix par défaut est « ON ».

### [Guidelines SETUP]

Si vous sélectionnez [ON] pour [Parking Guidelines], il est possible d'ajuster les instructions de parking.

### [Reverse with ATT (-20dB)]

Lorsque l'engrenage est déplacé en position de revers (R), le volume de l'appareil est réglé. La valeur de réglage par défaut est ON. Voir **Revers avec ATT (P.26)**

### [System Reset]

Touchez [System Reset] puis touchez [YES] pour ramener tous les réglages aux réglages initiaux par défaut.

### [Bluetooth]

Affiche l'écran des réglages Bluetooth. (P.27)

### [Dimmer]

Sélectionnez le mode d'atténuation de l'éclairage. «High» (par défaut) / «Mid» / «Low»

### [Demo]

Sélectionnez le mode de démonstration. Le choix par défaut est «ON».

### [Information]

Affiche la version du logiciel et le numéro de modèle de cette unité

## 5 Touchez [↵].

## Paramètres de l'horloge

### ☑ Synchronisation de l'heure avec FM RDS

Activer [RDS Clock Sync].

Voir **Configuration radio (P.23)**.

### ☑ Ajuster l'horloge manuellement

#### 🔑 REMARQUE

- Désactivez [RDS Clock Sync] avant de régler l'horloge.

## 1 Appuyez sur le bouton < 🏠 > .

## 2 Touchez [Settings].

## 3 Touchez [System].

## 4 Touchez [Time/Date].

L'écran de l'heure s'affiche.

## 5 Touchez [▲] ou [▼] pour régler l'heure de l'horloge.

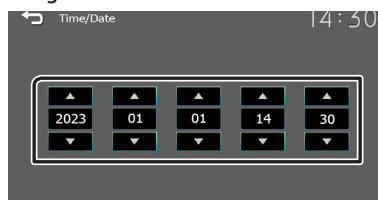

## 6 Touch [↵].

# Les bases

## Fonctions des boutons en façade

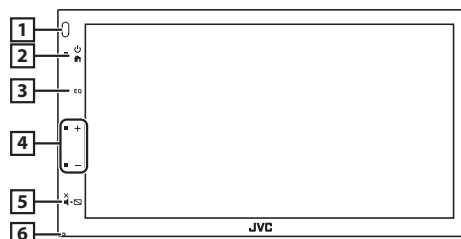

### 1 Capteur à distance

- Reçoit le signal de la télécommande.

### 2 (HOME)

- Affiche l'écran d'ACCUEIL. (P.21)
- Appuyer et maintenir le pour éteindre l'appareil.
- Permet de mettre l'appareil en marche lorsqu'il est éteint.

### 3 EQ

- Affiche l'écran audio.\* (P.28)
- \* L'écran audio ne s'affiche pas pendant l'écran de CONFIGURATION ou sur l'écran de liste, etc.,

### 4 +, - (Volume)

- Règle le volume. Le volume augmentera jusqu'à 15 tant que vous maintiendrez [ + ] enfoncé.

### 5 (MUTE, Display off) (Affichage éteint)

- Met sur muet/restaure le son.
- Appuyer et maintenir le pour éteindre l'écran. Lorsque l'écran est éteint, appuyez sur l'affichage pour activer l'écran.

### 6 Réinitialisation

- Si l'appareil ou l'appareil qui y est connecté ne fonctionne pas correctement, appuyer sur ce bouton pour que l'appareil retrouve les réglages d'usine.

## Opérations courantes

### ALLumer le courant

1 Appuyez sur le bouton > .



### Éteindre le courant

1 Appuyer et maintenir le bouton > .

## Descriptions de l'écran d'ACCUEIL

1 Appuyez sur le bouton > .



L'écran d'ACCUEIL apparaît.

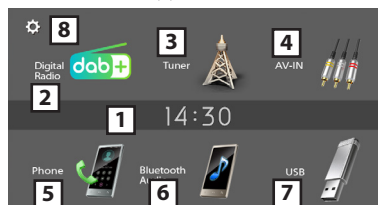

1 Affichage de l'horloge

Touchez pour afficher l'écran Horloge.

2 Passe à l'émission de radio numérique.\* (P.22)

\* KW-M180DBT uniquement

3 Passe à l'émission de radio. (P.23)

4 Passe à élément externe connecté à la borne d'entrée AV-IN. (P.26)

5 Affiche l'écran Mains libres. (P.27)

6 Lit depuis un lecteur audio Bluetooth. (P.28)

7 [USB]

Joue les fichiers d'un périphérique USB. (P.24)

[iPhone]

Lit depuis un iPhone. (P.25)

- Lorsqu'un iPhone est connecté.

[Mirroring]

Affiche l'écran de miroitage.

Lorsqu'un appareil Android avec l'application « Mirroring OB for JVC » installée est connecté.

8 Affiche l'écran de CONFIGURATION. (P.21)

## Écran de commande de source



1 : Revient à l'écran précédent.

: Affiche l'écran audio. (P.28)

# Radio numérique (KW-M180DBT)

## Utilisation de base de la radio numérique

1 Appuyez sur le bouton <🏠>.

2 Touchez [Digital Radio].

### ■ Écran de commande de source

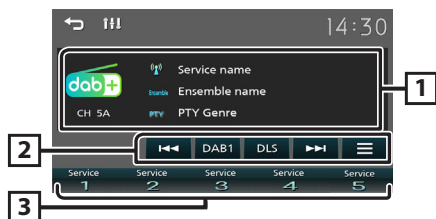

1 Affiche les informations concernant le service en cours :

Nom du service, nom de l'ensemble, genre PTY, canal

2 **[DAB]** : Bascule la bande pré-réglée de la radio numérique.

« DAB1 », « DAB2 », « DAB3 »

**[DLS]** : Afficher l'écran de segment d'Étiquette Dynamique

[◀▶] : Sélectionner un ensemble, un service et un composant.

[☰] : Affiche l'écran de réglages de la radio numérique. (P.22)

3 Rappelle le service mémorisé.

En le touchant pendant 2 secondes, il mémorise le service en cours de réception.

### ■ Mémoriser un service

Vous pouvez mémoriser le service que vous êtes en train de recevoir.

1 Rechercher un service que vous voulez présélectionner.

2 Toucher et maintenir [#] (#:1-5) dans lequel vous voulez mémoriser le service.

### ■ Sélectionner un service mémorisé

1 Toucher [#] (#:1-5).

## Configuration de la radio numérique

1 Touchez [☰].

2 Réglez chaque option comme suit.

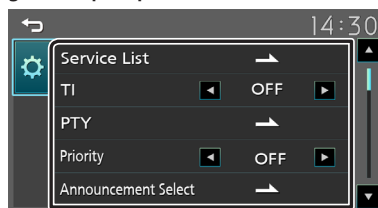

### [Service List]

Affiche l'écran de liste des services.

- [🔍] : Touchez-le puis touchez [Yes] pour rechercher la liste de services la plus récente.

### [TI]

Passer automatiquement aux informations de circulation routière à l'instant ou un bulletin d'infos-traffic débute.

« ON », « OFF » (par défaut)

### [PTY]

Recherche un programme par type de programme.

### [Priority]

Si le même service est fourni par Radio Data System alors que la réception du service Digital Radio s'affaiblit, la sélection se fait automatiquement sur Radio Data System.

« ON », « OFF » (par défaut)

### [Announcement Select]

Permet de passer au service d'annonce défini.

### [Related Service]

Lorsque vous sélectionnez MARCHÉ, l'appareil commute sur un service semblable (s'il existe) lorsqu'un réseau service DAB n'est pas disponible. Le choix par défaut est « OFF ».

### [Antenna Power]

Règle l'alimentation sur l'antenne de la Radio Numérique. Règle sur « ON » lorsque l'antenne de la Radio Numérique en cours d'utilisation est équipée d'un amplificateur. Le choix par défaut est « ON ».

3 Touchez [↩].

# Tuner

## Utilisation de base de la tuner

- 1 Appuyez sur le bouton <🏠>.
- 2 Touch [Tuner].

### 📺 Écran de commande de source

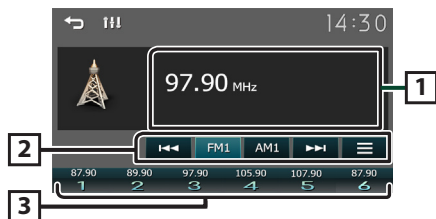

- 1 Affiche les informations concernant la station en cours :  
Nom PS, Fréquence, Genre PTY, Indicateur d'articles
- 2 **[FM]** : Change la bande FM.  
« FM1 », « FM2 », « FM3 »  
**[AM]** : Change la bande AM.  
« AM1 », « AM2 »  
**[◀▶]** : Syntonise automatiquement sur une station offrant une bonne réception.  
Touch and hold to switch to the next frequency manually.  
**[☰]** : Prédéfini automatiquement les stations. (P.23)
- 3 Rappelle la station mémorisée.  
En le touchant pendant 2 secondes, il mémorise la station en cours de réception.

## Présélectionner des stations

### 📺 Mémoire automatique

Vous pouvez présélectionner 6 stations pour la bande actuelle (FM1/FM2/FM3/AM1/AM2).

- 1 Appuyez sur [FM] ou [AM] pour sélectionner la bande.
- 2 Touchez [☰].
- 3 Touchez [Auto Store].  
Les stations locales avec les signaux les plus forts sont trouvées et enregistrées automatiquement.

### 📺 Mémoire manuelle

Vous pouvez mémoriser la station que vous êtes en train de recevoir.

- 1 Rechercher une station que vous voulez présélectionner.
- 2 Toucher et maintenir [#] (#:1-6) dans lequel vous voulez mémoriser la station.

### 📺 Rappel de la station prédéfinie

- 1 Toucher [#] (#:1-6).

## Configuration radio

- 1 Toucher [☰].
- 2 Réglez chaque option comme suit.

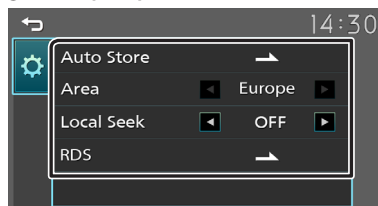

### [Auto Store]

Recherche et enregistre automatiquement les 6 stations avec les signaux les plus puissants pour la bande sélectionnée.  
« Auto Store » apparaît.

### [Area]

« Europe » : intervalles AM/FM: 9 kHz/50 kHz.

### [Local Seek]

Recherche uniquement les stations ayant une intensité suffisante de signal. (L'indicateur **LOC** s'allume.)  
« ON », « OFF » (par défaut)

### [RDS] \*1

Affiche l'écran des réglages RDS.

### [AF]

Lorsque la réception de la station est médiocre, sélectionne automatiquement une station diffusant le même programme sur le même réseau Radio Data System.  
« ON » (par défaut), « OFF »

### [TA]

Passer automatiquement aux informations de circulation routière à l'instant ou un bulletin d'infos-traffic débute. (L'indicateur **TI** s'allume.)  
« ON », « OFF » (par défaut)

### [RDS Clock Sync]

Synchroniser les données de temps de la station Radio Data System et l'horloge de cet appareil.  
« ON » (marche) (par défaut), « OFF » (arrêt)

### [PTY]

Sélectionner un type de programme.

### [PTY Seek]

Recherche un programme par type de programme

\*1 FM uniquement

- 3 Toucher [↵].

# USB

## Préparation

### ■ Connecter un périphérique USB

- 1 Retirer le capuchon de la borne USB.
- 2 Branchez le périphérique USB avec le câble USB

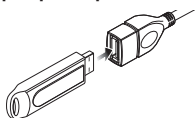

L'appareil lit le périphérique et la lecture commence.

### ■ Pour débrancher le périphérique USB

- 1 Appuyez sur le bouton <[Home]> .
- 2 Touchez une source autre que [USB].
- 3 Débranchez le périphérique USB.

### ■ Périphérique USB utilisable

Cet appareil peut lire les fichiers MPEG1/MPEG2/ MPEG4 /H.264/MKV/MP3/WMA/AAC/ WAV/FLAC/ OGG enregistrés dans un périphérique de stockage de masse USB. (P.34)

## Options de lecture

### ■ L'écran de commande de la source vous permet de gérer la musique que vous écoutez

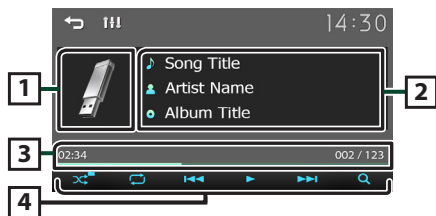

1 La pochette du fichier en cours de lecture s'affiche.

2 Affiche les informations concernant le fichier en cours.

3 Temps de lecture/numéro de fichier  
Barre du temps de lecture : Pour confirmer la position actuelle de lecture.

4 [Shuffle] : Sélectionne le mode de lecture aléatoire.

[Repeat] : Sélectionne le mode de lecture répétée.

[Play/Pause] : Lance la lecture ou met en pause.

[Previous/Next] : Recherche le contenu précédent/suivant.

Touchez et maintenez enfoncé pour effectuer une avance ou un retour rapide.

[Search] : Recherche le fichier (P.24)

### ■ Pour la lecture de vidéo

1 Lorsque les touches de fonctionnement ne sont pas affichées à l'écran, toucher l'écran.

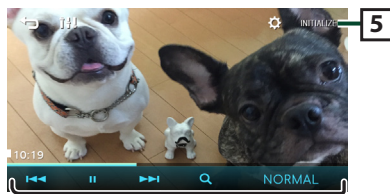

5 [Settings] : Vous pouvez régler la qualité d'image dans l'écran vidéo.

[Initialize] : Pour effacer le réglage.

6 [Play/Pause] : Lance la lecture ou met en pause.

[Previous/Next] : Recherche le contenu précédent/suivant.

Touchez et maintenez enfoncé pour effectuer une avance ou un retour rapide.

[Search] : Recherche le fichier. (P.24)

[Normal]/[16:9]/[4:3] : Sélectionnez un mode d'écran.

### ■ Sélection d'une piste dans une liste (Recherche le fichier)

1 Touchez [Search].

2 Sélectionnez le mode de recherche par fichiers audio [Music], ou fichiers vidéo [Video].

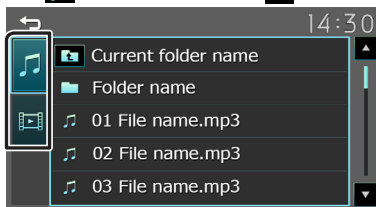

3 Touchez [Up] pour aller au niveau hiérarchique supérieur.

4 Touchez le dossier de votre choix.

Le contenu d'un dossier est affiché lorsque vous touchez celui-ci.

• Toucher [Up] pour aller au niveau hiérarchique supérieur.

5 Touchez l'élément de votre choix dans la liste des contenus.

La lecture commence.

### REMARQUE

• Touchez [Up] pour faire apparaître l'écran de contrôle source en haut de page.



# iPhone

## Préparation

### ■ Connexion d'un iPhone

- Pour en savoir plus sur la connexion iPhone, voir 33.

#### 1 Retirer le capuchon de la borne USB.

#### 2 Branchez l'iPhone.

L'appareil lit le périphérique et la lecture commence.

### ■ Pour débrancher l'iPhone

#### 1 Appuyez sur le bouton <🏠>.

#### 2 Toucher une source autre que [iPhone].

#### 3 Débranchez l'iPhone.

### ■ iPhone connectables

Les modèles suivants peuvent être reliés à cet appareil.

Convient pour

- iPhone 14 Pro Max
- iPhone 14 Pro
- iPhone 14 Plus
- iPhone 14
- iPhone 13 Pro Max
- iPhone 13 Pro
- iPhone 13
- iPhone 13 mini
- iPhone 12 Pro Max
- iPhone 12 Pro
- iPhone 12
- iPhone 12 mini
- iPhone SE (2nd generation)
- iPhone 11 Pro Max
- iPhone 11 Pro
- iPhone 11
- iPhone XS Max
- iPhone XS
- iPhone XR
- iPhone X
- iPhone 8 Plus
- iPhone 8
- iPhone 7 Plus
- iPhone 7
- iPhone SE
- iPhone 6s Plus
- iPhone 6s

### ✎ REMARQUE

- Si vous démarrez la lecture après avoir connecté l'iPhone, la musique qui a été lue par l'iPhone est jouée en premier.
- Fermer le port USB quand il n'est pas utilisé.

## Options de lecture

### ■ L'écran de commande de la source vous permet de gérer la musique que vous écoutez.

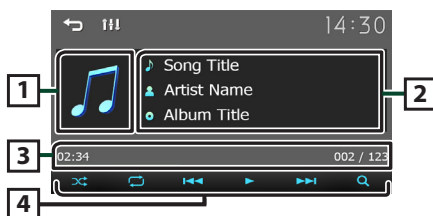

1 Illustration (Affiché si la piste contient un visuel)

2 Affiche les informations concernant le fichier en cours.

3 Temps de lecture/numéro de fichier  
**Barre du temps de lecture :** Pour confirmer la position actuelle de lecture.

4 [🎵] : Sélectionne le mode de lecture aléatoire.  
[🔍] : Sélectionne le mode de lecture répétée.  
[▶], [⏸] : Lit ou marque une pause.  
[⏮], [⏭] : Recherche le contenu précédent/suivant.  
Touchez et maintenez enfoncé pour effectuer une avance ou un retour rapide.  
[🔍] : Recherche le contenu. (P.25)

### ■ Sélectionner un contenu dans la liste

#### 1 Touchez [🔍].

#### 2 Touchez l'élément de votre choix.

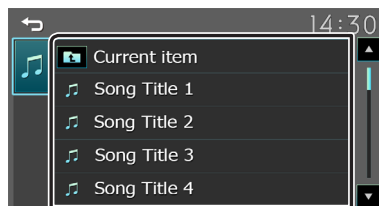

Le contenu d'une catégorie est affiché lorsque vous touchez celle-ci.

#### 3 Touchez l'élément de votre choix dans la liste des contenus.

La lecture commence.

- Toucher [↩] pour aller au niveau hiérarchique supérieur.

### ✎ REMARQUE

- Touchez [↩] pour faire apparaître l'écran de contrôle source en haut de page.

# Composants Externes

## Utilisant des lecteurs audio/vidéo externes

### ■ Démarrer la lecture

- 1 Connecter un composant externe à la borne d'entrée AV-IN. (P.32)
- 2 Appuyez sur le bouton <🏠>.
- 3 Toucher [AV-IN].
- 4 Allumer le composant connecté et commencer à lire la source.

### ■ Pour la lecture de vidéo

- 1 Lorsque les touches de fonctionnement ne sont pas affichées à l'écran, toucher l'écran.

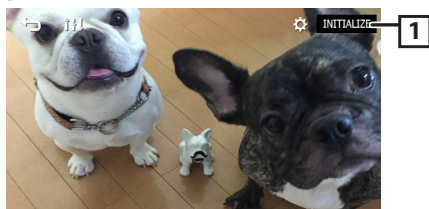

- 1 [⚙️]: Vous pouvez régler la qualité d'image dans l'écran vidéo.  
[INITIALIZE]: Pour effacer le réglage.

### 📎 REMARQUE

- Lorsque l'image de la caméra de recul s'affiche sur l'écran AV-IN, la sortie de l'image depuis la borne de sortie visuelle disparaît.

## Caméra de recul

Pour utiliser la caméra de recul, le câble de connexion INVERSE est requis. Pour connecter une caméra de recul. (P.32)

### ■ Affiche l'image de la caméra de recul

L'écran de vue arrière est affiché lorsque vous changez de vitesse pour la position de marche arrière (R).



- Le premier toucher enlève l'avertissement, et le deuxième toucher ferme l'écran de la caméra.

## Fonction d'apprentissage de la télécommande de direction

Cette fonction est disponible uniquement lorsque votre véhicule est équipé d'une télécommande de direction électrique.

- 1 Appuyez sur le bouton <🏠>.
- 2 Touchez [Settings].
- 3 Touchez [System].
- 4 Touchez [Steering Remote].
- 5 Touchez la fonction que vous souhaitez définir.
- 6 Appuyez sur le bouton de la télécommande de direction et maintenez-le enfoncé.

### 📎 REMARQUE

- Vous pouvez demander à l'appareil d'apprendre tous les boutons à la fois. Dans ce cas, appuyez sur tous les boutons un par un, et une fois qu'ils ont été tous enfoncés, touchez [↔️] dans l'écran Réglage de la télécommande de la direction.

- 7 Répétez les étapes 5 et 6 si nécessaire.

- 8 Touchez [↔️].

### 📎 REMARQUE

- Touchez [Initialize] puis touchez [Yes] pour ramener tous les réglages aux réglages initiaux par défaut.

## Revers avec ATT (-20dB)

Lorsque l'engrenage est déplacé en position de revers (R), le volume de l'appareil est réglé

- 1 Appuyez sur le bouton <🏠>.
- 2 Touchez [Settings].
- 3 Touchez [System].
- 4 Touchez [Reverse with ATT].
- 5 Touchez [◀] or [▶] définir à [ON]/[OFF].

### 📎 REMARQUE

- La valeur de réglage est ON (par défaut)

# Bluetooth

## Enregistrer votre smartphone dans l'appareil

Vous pouvez utiliser votre smartphone Bluetooth lié à cet appareil.

- 1 Activer la fonction Bluetooth sur votre smartphone/téléphone portable.
- 2 Recherchez l'appareil («KW-M180DBT» / «KW-M180BT») à partir de votre smartphone/ téléphone portable.

Si un code PIN est requis, entrez le code PIN («0000»).

-  apparaît quand le Bluetooth du smartphone est connecté.

### Déconnecter le périphérique

- Désactiver la fonction Bluetooth sur votre smartphone/téléphone portable.
- Mettre sur arrêt l'interrupteur d'allumage.

## Recevoir un appel

### 1 Touchez [].

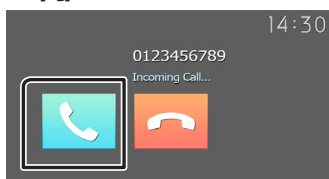

- []: Rejeter un appel entrant.

### Actions possibles pendant un appel

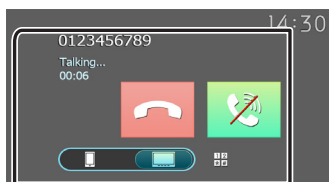

[] Raccrocher

[] Muet ta voix

 Vous pouvez envoyer des tonalités en touchant les touches voulues à l'écran.  
• Touchez [] pour fermer la fenêtre.

 Bascule l'émission de la voix entre le smartphone / téléphone portable et le haut-parleur.

- Régler le volume de réception  
Appuyez sur le bouton <+> ou <->.





## Passer un appel

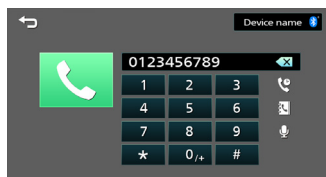



- 1 Press the <PHONE> button.
- 2 Touch [TEL].
- 3 See the table below for each operation method.





### Appel par entrée d'un numéro de téléphone

- 1) Utilisez les touches numériques pour entrer un numéro de téléphone.
- 2) Touchez [].  
Passer un appel
- Touchez [] pour supprimer la dernière saisie.

### Appel depuis l'historique des appels





- 1) Touchez [].
- 2) Touchez [] (appels entrants), [] (appels sortants), [] (appels manqués).
- 3) Sélectionnez dans la liste le numéro de téléphone.  
Passer un appel

### Appel depuis le répertoire téléphonique

- 1) Touchez [].
- 2) Sélectionnez le nom dans la liste.  
Passer un appel
- []: Met à jour le répertoire téléphonique.  
Appuyez sur cette touche après avoir effectué une modification dans le répertoire de votre smartphone/ téléphone portable.

### Appel en attente

Lorsque vous recevez un nouvel appel en cours d'appel:

- 1) Touchez [], l'appel en cours sera mise en attente, et vous pouvez répondre au nouvel appel.
- 2) À chaque touche sur [], l'appel actuel passera à un autre appel.
- 3) Si vous touchez [] pendant l'appel en attente, l'appel entrant sera rejeté.
- 4) Si vous touchez [], l'appel actuel sera terminé et vous pourrez passer à l'appel en attente.
- 5) Touchez [] pour vous mettre en sourdine

## Bluetooth

### Utilisation d'un appareil audio Bluetooth en lecture

- 1 Appuyez sur le bouton <Home>.
- 2 Appuyez sur [Bluetooth Audio].

#### Écran de commande de source

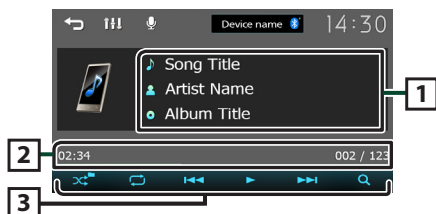

- 1 Affiche les informations concernant le fichier en cours.
- 2 Temps de lecture/numéro de fichier  
**Barre du temps de lecture :** Pour confirmer la position actuelle de lecture.
- 3 [ ] : Sélectionne le mode de lecture aléatoire.  
[ ] : Sélectionne le mode de lecture répétée.  
[ ] : Lit ou marque une pause.  
[ ] : Recherche le contenu précédent/suivant.  
Touchez et maintenez enfoncé pour effectuer une avance ou un retour rapide.  
[ ] : Recherche le fichier. (P.28)

#### REMARQUE

- Certains indicateurs de fonctionnement et d'affichage peuvent différer en fonction de leur disponibilité sur l'appareil connecté.

#### Sélectionner un contenu dans la liste

- 1 Touchez [Q].
- 2 Touchez l'élément de votre choix.  
Le contenu d'une catégorie est affiché lorsque vous touchez celle-ci.
- 3 Touchez l'élément de votre choix dans la liste des contenus.  
La lecture commence.
  - Toucher [ ] pour aller au niveau hiérarchique supérieur.

#### REMARQUE

- Touchez [ ] pour faire apparaître l'écran de contrôle source en haut de page.

## Contrôle de l'audio

Vous pouvez régler différents paramètres, comme la balance audio ou le niveau du caisson de graves par exemple.

- 1 Appuyez sur le bouton <EQ>.
- 2 Veuillez consulter le tableau ci-dessous pour chaque méthode de fonctionnement.

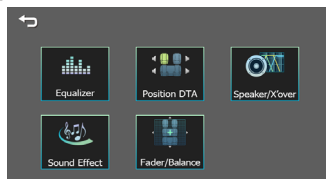

### Contrôle de l'audio en général

- 1 Appuyez sur le bouton <EQ>.
- 2 Touchez [Fader / Balance].
- 3 Réglez chaque option comme suit.

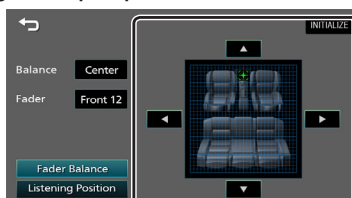

#### [Fader Balance]

<b>Balance</b> [ ] [ ]	Régler le volume de la balance à droite/gauche. 15 (gauche) à 15 (droite)
<b>Fader</b> [ ] [ ]	Réglez le volume de la balance avant/arrière. 15 (avant) à 15 (arrière)
<b>[INITIALIZE]</b>	Pour effacer le réglage..

#### [Listening Position]

<b>[ ]</b>	Sélectionnez une position d'écoute parmi « Front Left », « Front All », « Front Right » et « Middle ».
<b>[INITIALIZE]</b>	Pour effacer le réglage.

# Installation

## Avant l'installation

Avant d'installer cet appareil, veuillez prendre les mesures de précaution suivantes.

### ▲ AVERTISSEMENTS

- Si vous branchez le câble d'allumage (rouge) et le câble de la batterie (jaune) au châssis de la voiture (masse), il peut y avoir un court-circuit entraînant, à son tour, un incendie. Il faut toujours brancher ces câbles à la source d'alimentation fonctionnant via le boîtier de fusibles.
- Ne débranchez pas le fusible du câble d'allumage (rouge) ni du câble de la batterie (jaune). L'alimentation électrique doit être connectée aux câbles via le fusible.

### ▲ ATTENTION

- Installez cet appareil dans la console du véhicule. Ne touchez pas les éléments métalliques de cet appareil pendant et juste après l'utilisation de l'appareil. Les éléments métalliques tels que le dissipateur thermique et le coffret sont très chauds.

### REMARQUE

- Le montage et le câblage de ce produit requièrent expérience et savoir-faire. Pour des questions de sécurité, les travaux de montage et de câblage doivent être effectués par des professionnels.
- Veillez à brancher l'appareil à une alimentation électrique négative de 12 Vcc avec mise à la terre.
- N'installez pas l'appareil dans un endroit directement exposé aux rayons du soleil, à une chaleur excessive ou à l'humidité. Évitez également les endroits trop poussiéreux ou susceptibles d'être éclaboussés par de l'eau.
- N'utilisez pas vos propres vis. N'utilisez que les vis fournies. L'utilisation de vis non appropriées risque d'endommager l'appareil.
- Si l'allumage de votre véhicule ne possède pas de position ACC, branchez les câbles d'allumage à une source d'alimentation que la clé de contact peut allumer ou éteindre. Si vous branchez le câble d'allumage à une source d'alimentation à tension constante comme les câbles de la batterie, il se peut que la batterie se décharge.
- Si la console est dotée d'un couvercle, veillez à installer l'appareil de sorte que la façade ne heurte pas le couvercle quand elle s'ouvre ou se ferme.
- Si le fusible saute, vérifiez d'abord que les câbles ne se touchent pas afin d'éviter tout court-circuit, puis remplacez l'ancien fusible par un nouveau fusible de même puissance.
- Isolez les câbles non connectés avec un ruban vinyl, ou tout autre matériau similaire. Pour éviter tout

court-circuit, ne retirez pas les capuchons placés aux extrémités des câbles non connectés ou des bornes.

- Fixez les fils à l'aide de colliers et enroulez le ruban de vinyle autour des fils qui entre en contact avec les parties métalliques afin de protéger les fils et éviter tout court-circuit.
- Branchez correctement les câbles de l'enceinte aux bornes correspondantes. L'appareil peut subir des dommages et ne plus fonctionner si vous partagez les fils ⊖ ou les mettez à la masse avec une partie métallique du véhicule.
- Si seulement deux enceintes sont branchées au système, branchez les connecteurs soit aux bornes de sortie avant soit aux bornes de sortie arrière (ne pas mélanger les bornes de sortie avant et arrière). Par exemple, si vous connectez le connecteur ⊕ de l'enceinte gauche à une borne de sortie avant, ne connectez pas le connecteur ⊖ à une borne de sortie arrière.
- Une fois l'appareil installé, vérifiez que les feux de freinage, les clignotants et les essuie-glace, etc. du véhicule fonctionnent correctement.
- L'angle de montage de l'appareil doit être inférieur ou égal à 30°.
- N'exercez pas de pression excessive sur la surface du panneau lors de l'installation de l'appareil dans le véhicule. Cela risque de rayer la surface, de l'endommager ou d'entraîner une défaillance.
- Il se peut que la réception soit mauvaise si des objets métalliques se trouvent à proximité de l'antenne Bluetooth.

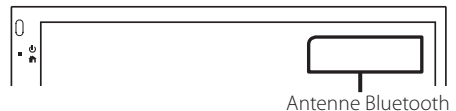

## Installation

### ■ Accessoires fournis pour l'installation

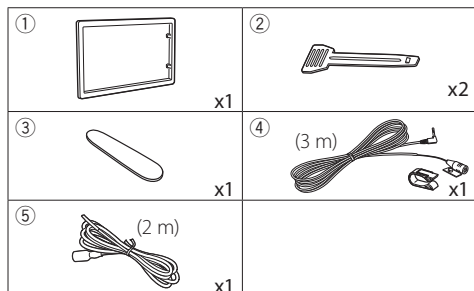

### ■ Procédure d'installation

- 1) Pour éviter les courts-circuits, retirez la clé de contact, puis débranchez la borne  $\ominus$  de la batterie.
- 2) Veillez à effectuer correctement les connexions des câbles d'entrée et de sortie pour chaque appareil.
- 3) Branchez le câble sur le faisceau de fils.
- 4) Prenez le connecteur B sur le faisceau de fils, puis branchez-le au connecteur de l'enceinte dans votre véhicule.
- 5) Prenez le connecteur A sur le faisceau de fils, puis branchez-le à la prise d'alimentation externe de votre véhicule.
- 6) Branchez le connecteur du faisceau de fils sur l'appareil.
- 7) Installez l'appareil dans votre véhicule.
- 8) Reconnectez la borne  $\ominus$  de la batterie.
- 9) Appuyez sur le bouton réinitialiser.

### Installation de l'appareil

#### ■ Voitures non-japonaises

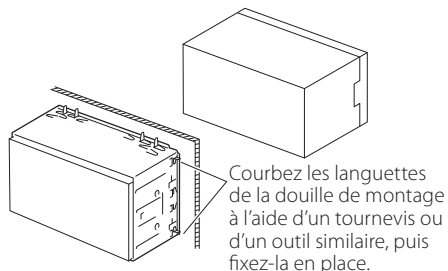

#### REMARQUE

- Vérifiez que l'appareil est correctement en place. Si l'appareil n'est pas stable, cela peut occasionner un dysfonctionnement (le son peut par exemple sauter).

#### ■ Plaque de garniture

- 1) Fixez l'accessoire ① sur l'appareil.

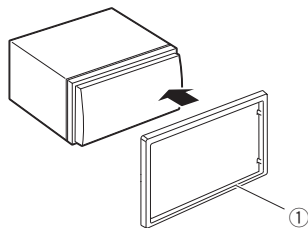

## Installation

### ■ Microphone

- 1) Vérifiez la position d'installation du microphone (accessoire ④).
- 2) Nettoyez la surface d'installation.
- 3) Retirez le séparateur du microphone (accessoire ④) et collez le microphone à l'emplacement indiqué ci-dessous.
- 4) Branchez le câble du microphone sur l'appareil en le fixant à divers endroits à l'aide de ruban adhésif ou de toute autre méthode appropriée.
- 5) Réglez l'orientation du microphone (accessoire ④) en direction du conducteur.

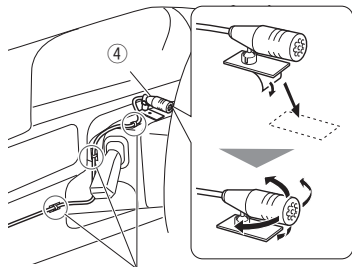

Fixez un câble avec du ruban spécialement prévu à cet effet.

### REMARQUE

- Échanger les attaches si nécessaire.



### ■ Retrait de la plaque de garniture

- 1) Utilisez la clé d'extraction (accessoire ③) pour sortir les quatre languettes (deux sur la partie gauche, deux sur la partie droite) en effectuant un mouvement de levier.

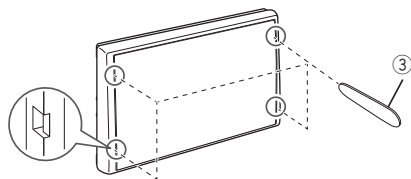

- 2) Tirer la plaque de garniture vers l'avant.

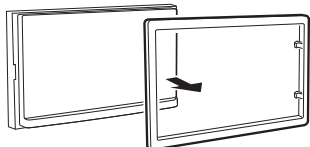

### ■ Retrait de l'appareil

- 1) Retirez la plaque de garniture en vous référant à l'étape 1 dans «Retrait de la plaque de garniture».
- 2) Insérez la clé d'extraction (accessoire ②) profondément dans l'emplacement, comme illustré. (La saillie à la pointe de la clé d'extraction doit faire face à l'appareil.)

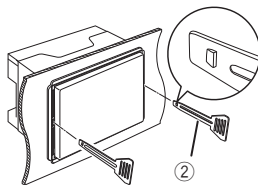

- 3) Une fois que vous avez correctement inséré la clé d'extraction, insérez l'autre clé d'extraction dans l'emplacement.

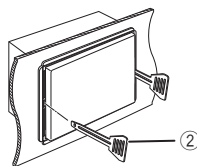

- 4) Extraire l'appareil à moitié.

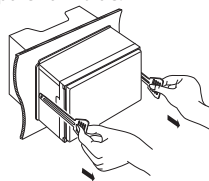

### REMARQUE

- Veillez à ne pas vous blesser avec les broches d'arrêt sur la clé d'extraction.
- 5) Tenez l'appareil des deux mains et faites-le sortir complètement en veillant à ne pas le laisser tomber.

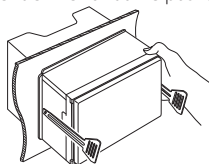

# Installation

## Connexion des câbles sur les contacts électriques

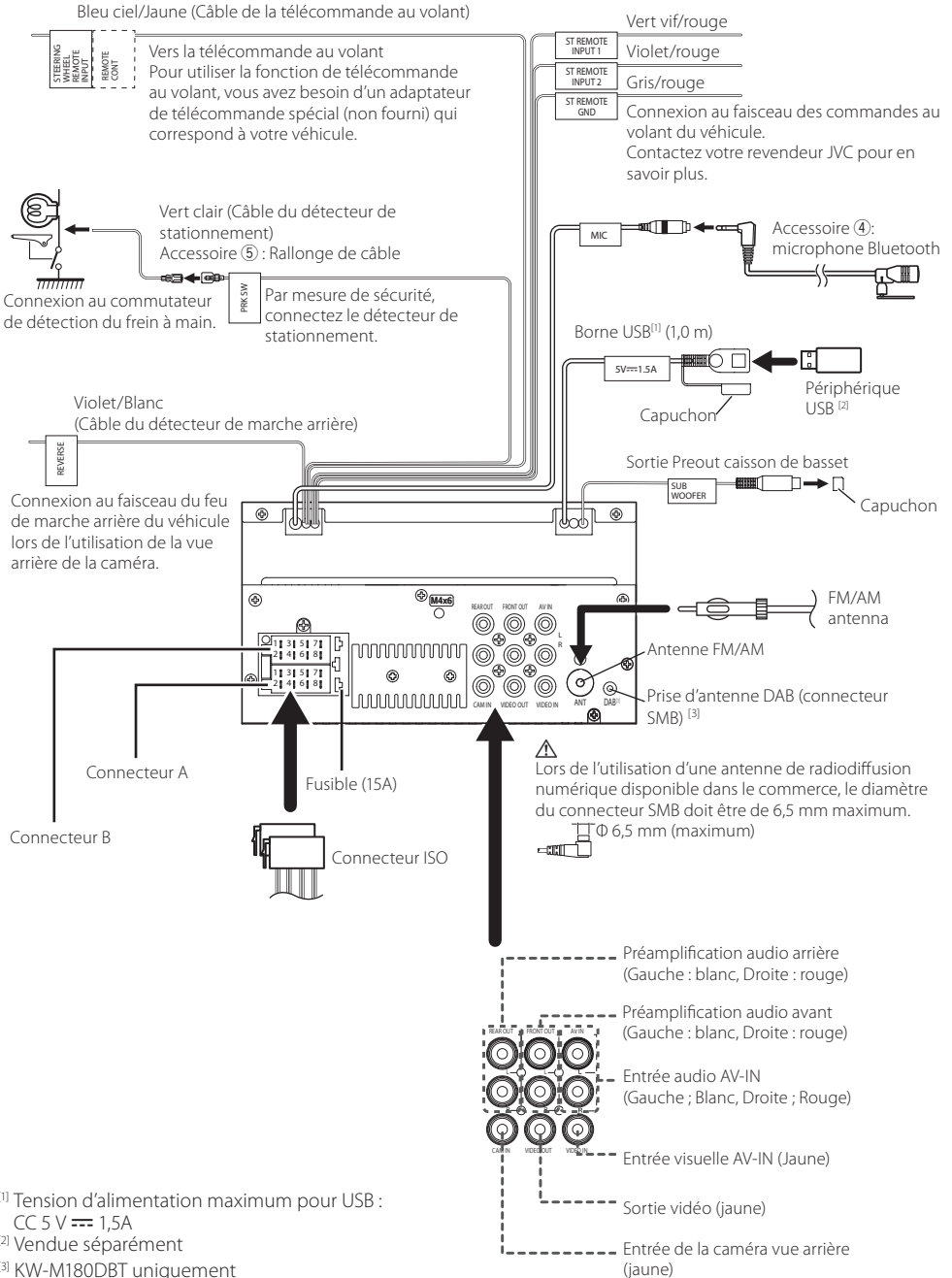

<sup>[1]</sup> Tension d'alimentation maximum pour USB : CC 5 V ± 1,5A

<sup>[2]</sup> Vendue séparément

<sup>[3]</sup> KW-M180DBT uniquement



## Installation

### Guide de fonctionnement des connecteurs du faisceau de câbles

Broche	Couleur et fonction	
A-4	Jaune	Batterie
A-5	Bleu/Blanc <sup>[1]</sup>	Réglage de puissance
A-7	Rouge	Allumage (ACC)
A-8	Noir	Branchement à la terre (masse)
B-1/B-2	Violet (+)/Violet/Noir (-)	Arrière droit
B-3/B-4	Gris (+)/Gris/Noir (-)	Avant droit
B-5/B-6	Blanc (+)/Blanc/Noir (-)	Avant gauche
B-7/B-8	Vert (+) / Vert/Noir (-)	Arrière gauche

<sup>[1]</sup> Max. 150 mA, 12 V

- Impédance d'enceinte : 4-8 Ω

### ⚠ ATTENTION

Avant de connecter les connecteurs ISO à l'unité, vérifier les conditions suivantes :

- Veiller à ce que l'affectation des broches du connecteur corresponde à l'unité JVC.
- Prendre un avis supplémentaire pour le câble d'alimentation.
- Si les câbles d'alimentation et de contact ne correspondent pas, les changer en conséquence.
- Si le véhicule ne dispose pas d'un câble de démarrage, utiliser une interface disponible dans le commerce.

### Branchement d'un iPhone/Android

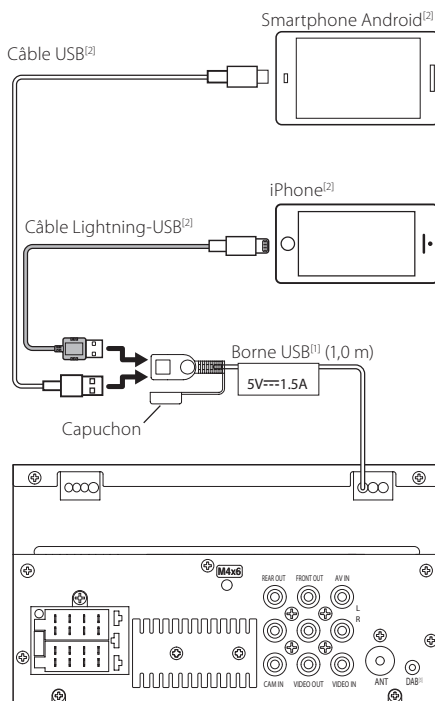

<sup>[1]</sup> Tension d'alimentation maximum pour USB : CC 5 V --- 1,5A

<sup>[2]</sup> Vendue séparément

<sup>[3]</sup> KW-M180DBT uniquement

# À propos de cet appareil

## Plus d'informations

### ■ Périphérique USB utilisable

Cet appareil peut lire les fichiers MPEG1/ MPEG2/ MPEG4/H.264/MKV/ MP3/WMA/ AAC/ WAV/ FLAC/ OGG enregistrés dans un périphérique de stockage de masse USB.

- Système de fichier : FAT16 / FAT32 / NTFS / exFAT
- Cet appareil peut reconnaître un total de 9 999 fichiers et 320 dossiers (avec un maximum de 9 999 fichiers par dossier).
- Nombre maximum de caractères :
  - Nom de dossier : 70 caractères
  - Nom de fichier : 70 caractères
  - Marqueur : 70 caractères

### REMARQUE

- Quand la périphérique USB est connectée à cet appareil, elle peut être chargée avec le câble USB.
- Installer la périphérique USB de façon à ce que cela ne vous empêche pas de conduire prudemment.
- Vous ne pouvez pas connecter de périphérique USB au moyen d'un hub USB et d'un lecteur multi-cartes.
- Faites des sauvegardes des fichiers audio utilisés avec cet appareil. Les fichiers peuvent être effacés en fonction des conditions de fonctionnement du périphérique USB.  
Nous ne proposons pas d'indemnités pour les pertes dues à l'effacement de données.
- Aucun périphérique USB n'est fourni avec cet appareil. Vous devez acheter un périphérique USB disponible dans le commerce.
- Fermer le port USB quand il n'est pas utilisé.

### ■ Fichiers audio lisibles

Format audio	Débit binaire/ (Compte de bits)	Fréquence d'échantillonnage
MP3 (.mp3)	16 – 320kbps/VBR	16 – 48 kHz
WMA (.wma)	16 – 320kbps	16 – 48 kHz
AAC-LC (.m4a)	16 – 320kbps	16 – 48 kHz
Linear PCM (WAVE) (.wav)	(16/24 bit)	8 – 192 kHz
FLAC (.flac)	(16/24 bit)	8 – 192 kHz
Vorbis (.ogg)	(16/24 bit)	8 – 192 kHz

- Cette unité peut montrer ID3 Tag Version 1.0/1.1/2.2/2.3/2.4 (pour MP3).

### REMARQUE

- Les formats WMA et AAC protégés par GDN ne peuvent pas être lus.
- Bien que les fichiers audio soient conformes aux normes susmentionnées, la lecture peut se révéler impossible en fonction des types et conditions du support ou du périphérique.

### ■ Fichiers vidéo acceptés

Format vidéo	Codec vidéo	Codec Audio
MPEG-1 (.mpg, .mpeg)	MPEG-1	MPEG Audio Layer 2
MPEG-2 (.mpg, .mpeg)	MPEG-2	MPEG Audio Layer 2
MPEG-4 (.mp4, .avi)	MPEG-4 (SP,ASP)	MP3, AAC-LC (2ch)
H.264/MPEG-4 AVC (.mp4, mkv, avi, .flv, .f4v)	H.264/MPG-4 AVC (BP/MP/HP)	MP3, AAC (2ch)
MKV (.mkv)	Le format vidéo suit H.264/MPEG-4 AVC, MPEG4, XVID	MP3, AAC, Vorbis, FLAC

## Spécifications

### ■ Section Bluetooth

#### Section Bluetooth

: 2,4 – 2,48 GHz

#### RF Output Power (E.I.R.P.)

: +8dBm (MAX)

### ■ Section audio

#### Impédance d'enceinte

: 4 – 8 Ω

### ■ Général

#### Tension de fonctionnement

: batterie de voiture 12 V CC

## À propos de cet appareil

### Copyrights

- La marque et les logos Bluetooth sont des marques déposées appartenant à Bluetooth® SIG, Inc. et toute utilisation de ces marques par JVC/KENWOOD Corporation est sous licence. Les autres marques déposées et appellations commerciales appartiennent à leurs propriétaires respectifs.
- Use of the Made for Apple badge means that an accessory has been designed to connect specifically to the Apple product(s) identified in the badge and has been certified by the developer to meet Apple performance standards. Apple is not responsible for the operation of this device or its compliance with safety and regulatory standards. Please note that the use of this accessory with an Apple product may affect wireless performance.
- Apple, iPhone and Lightning are trademarks of Apple Inc., registered in the U.S. and other countries.
- Android is a trademark of Google LLC.
- Microsoft and Windows Media are either registered trademarks or trademarks of Microsoft Corporation in the United States and/or other countries.
- THIS PRODUCT IS LICENSED UNDER THE MPEG-4 VISUAL PATENT PORTFOLIO LICENSE FOR THE PERSONAL AND NON-COMMERCIAL USE OF A CONSUMER FOR (j) ENCODING VIDEO IN COMPLIANCE WITH THE MPEG-4 VISUAL STANDARD ("MPEG-4 VIDEO") AND/OR (jj) DECODING MPEG-4 VIDEO THAT WAS ENCODED BY A CONSUMER ENGAGED IN A PERSONAL AND NON-COMMERCIAL ACTIVITY AND/OR WAS OBTAINED FROM A VIDEO PROVIDER LICENSED BY MPEG LA TO PROVIDE MPEG-4 VIDEO. NO LICENSE IS GRANTED OR SHALL BE IMPLIED FOR ANY OTHER USE. ADDITIONAL INFORMATION INCLUDING THAT RELATING TO PROMOTIONAL, INTERNAL AND COMMERCIAL USES AND LICENSING MAY BE OBTAINED FROM MPEG LA, LLC. SEE [HTTP://WWW.MPEGLA.COM](http://www.MPEGLA.COM).
- THIS PRODUCT IS LICENSED UNDER THE AVC PATENT PORTFOLIO LICENSE FOR THE PERSONAL USE OF A CONSUMER OR OTHER USES IN WHICH IT DOES NOT RECEIVE REMUNERATION TO (j) ENCODE VIDEO IN COMPLIANCE WITH THE AVC STANDARD ("AVC VIDEO") AND/OR (jj) DECODE AVC VIDEO THAT WAS ENCODED BY A CONSUMER ENGAGED IN A PERSONAL ACTIVITY AND/OR WAS OBTAINED FROM A VIDEO PROVIDER LICENSED TO PROVIDE AVC VIDEO. NO LICENSE IS GRANTED OR SHALL BE IMPLIED FOR ANY OTHER USE. ADDITIONAL INFORMATION MAY BE OBTAINED FROM MPEG LA, L.L.C. SEE [HTTP://WWW.MPEGLA.COM](http://www.MPEGLA.COM)
- libFLAC  
Copyright (C) 2000-2009 Josh Coalson  
Copyright (C) 2011-2013 Xiph.Org Foundation
  - Redistribution and use in source and binary forms, with or without modification, are permitted provided that the following conditions are met:
  - Redistributions of source code must retain the above copyright notice, this list of conditions and the following disclaimer.

- Redistributions in binary form must reproduce the above copyright notice, this list of conditions and the following disclaimer in the documentation and/or other materials provided with the distribution.

Neither the name of the Xiph.org Foundation nor the names of its contributors may be used to endorse or promote products derived from this software without specific prior written permission.

THIS SOFTWARE IS PROVIDED BY THE COPYRIGHT HOLDERS AND CONTRIBUTORS "AS IS" AND ANY EXPRESS OR IMPLIED WARRANTIES, INCLUDING, BUT NOT LIMITED TO, THE IMPLIED WARRANTIES OF MERCHANTABILITY AND FITNESS FOR A PARTICULAR PURPOSE ARE DISCLAIMED. IN NO EVENT SHALL THE FOUNDATION OR CONTRIBUTORS BE LIABLE FOR ANY DIRECT, INDIRECT, INCIDENTAL, SPECIAL, EXEMPLARY, OR CONSEQUENTIAL DAMAGES (INCLUDING, BUT NOT LIMITED TO, PROCUREMENT OF SUBSTITUTE GOODS OR SERVICES; LOSS OF USE, DATA, OR PROFITS; OR BUSINESS INTERRUPTION) HOWEVER CAUSED AND ON ANY THEORY OF LIABILITY, WHETHER IN CONTRACT, STRICT LIABILITY, OR TORT (INCLUDING NEGLIGENCE OR OTHERWISE) ARISING IN ANY WAY OUT OF THE USE OF THIS SOFTWARE, EVEN IF ADVISED OF THE POSSIBILITY OF SUCH DAMAGE.

#### • libogg

Copyright (c) 2002, Xiph.org Foundation Redistribution and use in source and binary forms, with or without modification, are permitted provided that the following conditions are met:

- Redistributions of source code must retain the above copyright notice, this list of conditions and the following disclaimer.

- Redistributions in binary form must reproduce the above copyright notice, this list of conditions and the following disclaimer in the documentation and/or other materials provided with the distribution.

- Neither the name of the Xiph.org Foundation nor the names of its contributors may be used to endorse or promote products derived from this software without specific prior written permission.

THIS SOFTWARE IS PROVIDED BY THE COPYRIGHT HOLDERS AND CONTRIBUTORS "AS IS" AND ANY EXPRESS OR IMPLIED WARRANTIES, INCLUDING, BUT NOT LIMITED TO, THE IMPLIED WARRANTIES OF MERCHANTABILITY AND FITNESS FOR A PARTICULAR PURPOSE ARE DISCLAIMED. IN NO EVENT SHALL THE FOUNDATION OR CONTRIBUTORS BE LIABLE FOR ANY DIRECT, INDIRECT, INCIDENTAL, SPECIAL, EXEMPLARY, OR CONSEQUENTIAL DAMAGES (INCLUDING, BUT NOT LIMITED TO, PROCUREMENT OF SUBSTITUTE GOODS OR SERVICES; LOSS OF USE, DATA, OR PROFITS; OR BUSINESS INTERRUPTION) HOWEVER CAUSED AND ON ANY THEORY OF LIABILITY, WHETHER IN CONTRACT, STRICT LIABILITY, OR TORT (INCLUDING NEGLIGENCE OR OTHERWISE) ARISING IN ANY WAY OUT OF THE USE OF THIS SOFTWARE, EVEN IF ADVISED OF THE POSSIBILITY OF SUCH DAMAGE.

# Contenido

Antes de la utilización .....	36
Cómo leer este manual.....	36
Precauciones.....	36
Inicio .....	37
Ajustes del reloj.....	37
Conceptos básicos.....	38
Funciones de los botones del panel frontal .....	38
Funciones habituales.....	38
Pantalla de INICIO.....	38
Pantalla de control de fuente.....	38
Radio digital.....	39
Funcionamiento básico de la radio digital.....	39
Configuración de la radio digital.....	39
Tuner .....	40
Manejo básico de tuner.....	40
Emisoras preestablecidas.....	40
Configuración de tuner.....	40
USB .....	41
Preparativos.....	41
Operaciones de reproducción.....	41
iPhone .....	42
Preparativos.....	42
Operaciones de reproducción.....	42
Componentes externos.....	43
Uso de reproductores de audio/vídeo exteriores.....	43
Cámara de visión trasera.....	43
Función de aprendizaje del mando a distancia de la dirección.....	43
Reverse with ATT.....	43
Bluetooth .....	44
Registre su teléfono inteligente en la unidad .....	44
Reciba una llamada telefónica.....	44
Realice una llamada telefónica.....	44
Reproducir dispositivos de audio Bluetooth.....	45
Control del audio.....	45
Controlling General Audio.....	45
Instalación .....	46
Antes de la instalación.....	46
Instalación de la unidad .....	47
Acerca de esta unidad.....	51
Más información.....	51
Especificaciones .....	51
Derechos de autor.....	52

• Para obtener más detalles sobre la información de la guía y sobre las operaciones descritas, consulte el MANUAL DE INSTRUCCIONES en el siguiente sitio web:

<<https://www.jvc.net/cs/car/>>.



# Antes de la utilización

## Cómo leer este manual

- Los paneles que se incluyen en este manual son ejemplos utilizados para ofrecer explicaciones de las distintas operaciones. Por esta razón, pueden diferir de los paneles que se visualizan en realidad.
- En los procedimientos operativos, las llaves indican la tecla o botón que debe emplear.  
< >: Indica el nombre de los botones del panel.  
[ ]: Indica el nombre de las teclas.

 Este símbolo en el producto indica que hay importantes instrucciones de funcionamiento y mantenimiento en este manual. Asegúrese de leer atentamente las instrucciones de este manual.

## Precauciones

### ADVERTENCIA

#### Para evitar lesiones o incendios, tome las precauciones siguientes:

- Para evitar un cortocircuito, nunca coloque ni deje objetos metálicos (como monedas o herramientas metálicas) dentro de la unidad.
- No mire fijamente la pantalla de la unidad mientras está conduciendo durante un periodo prolongado de tiempo.
- Si tiene problemas durante la instalación, consulte con su distribuidor JVC.

#### Precauciones para el uso de esta unidad

- Cuando compre accesorios opcionales, pregunte a su distribuidor JVC si dichos accesorios son compatibles con su modelo y en su región.
- Puedes elegir un idioma para mostrar los menús, las etiquetas de los archivos de audio, etc. Véase **Inicio (P.37)**
- La función Radio Data System o Radio Broadcast Data System no funcionará en lugares donde no existan emisoras compatibles con este servicio.

#### Cómo proteger el monitor

- Para proteger el monitor de posibles daños, no lo utilice con un bolígrafo con punta de bola o una herramienta similar con una punta afilada.

#### Limpieza de la unidad

Si el panel frontal de esta unidad está manchado, límpielo con un paño suave y seco, como por ejemplo, un paño de silicona. Si el panel frontal está muy manchado, limpie la mancha con un paño humedecido con un producto de limpieza neutro y, a continuación, vuelva a limpiarlo con un paño suave, limpio y seco.

### PRECAUCIÓN

- Aplicar un limpiador en spray directamente sobre la unidad, puede dañar sus componentes mecánicos. Limpiar el panel frontal con un paño áspero o con un líquido volátil, como un disolvente o alcohol, podría rayar la superficie o borrar las impresiones de la pantalla.

#### Cómo reiniciar la unidad

Si la unidad o la unidad conectada no funcionan correctamente, reiniciela.

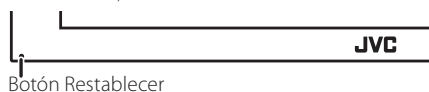

# Inicio

## 1 Coloque la llave de encendido del coche en la posición ACC.

La unidad se pone en marcha. Por favor, lea el aviso y pulse "Agree" para entrar en la pantalla.



## 2 Pulse el botón < 🏠 > .

## 3 Toque [Settings].

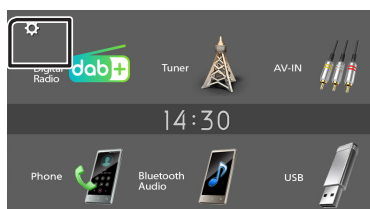

## 4 Toque la tecla correspondiente y establezca un valor.

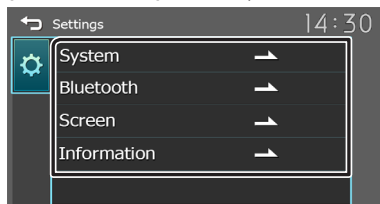

### [System]

#### [Beep Tone]

Activa o desactiva el tono de las teclas. "ON" (ACTIVADO) (Predeterminado), "OFF" (DESACTIVADO)

#### [Language]

Seleccione el idioma utilizado para la pantalla de control y los elementos de configuración. El idioma predeterminado es "English" (inglés).

#### [Time/Date]

Ajuste la hora del reloj. (P.37)

#### [Clock Mode]

Seleccione el formato de visualización de la hora. [12hr]/[24hr] (predeterminado)

#### [Steering Remote]

Ajusta la función deseada del controlador remoto del volante. Consulte **Función de aprendizaje del mando a distancia de la dirección (P.43)**

#### [Parking Guidelines]

Podrá visualizar las pautas de parking para permitir un parking más sencillo al engranar la marcha a la posición de marcha atrás (R). La opción predeterminada es "ON".

### [Guidelines SETUP]

Si selecciona [ON] para [Parking Guidelines], podrá ajustar las pautas de aparcamiento. Consulte

### [Inverso con ATT (-20dB)]

Ajusta el volumen de la unidad cuando la marcha se desplaza a la posición de marcha atrás (R). La configuración predeterminada es "ON". Véase **Inverso con ATT (P.43)**.

### [System Reset]

Toque [System Reset] y después toque [YES] para establecer todos los ajustes en los ajustes iniciales predeterminados.

### [Bluetooth]

Muestra la pantalla Configuración de Bluetooth (P.44)

### [Screen]

#### [Dimmer]

Seleccione el modo de atenuación. "High" (predeterminado)/"Mid"/"Low"

#### [Demo]

Seleccione el modo de demostración. La opción predeterminada es "ON".

### [Information]

Muestra la versión del software y el número de modelo de esta unidad

## 5 Toque [↵].

## Ajustes del reloj

### ☑ Sincronización de la hora del reloj con FM RDS

Activa [RDS Clock Sync].

Consulte **Configuración de radio (P.40)**.

### ☑ Ajuste del reloj manualmente

#### 📎 NOTA

- Desactive [RDS Clock Sync] antes de ajustar el reloj.

## 1 Pulse el botón < 🏠 >

## 2 Toque [Settings].

## 3 Toque [System].

## 4 Toque [Time/Date].

Aparece la pantalla del reloj.

## 5 Toque el botón [▲] o [▼] para ajustar la hora del reloj.

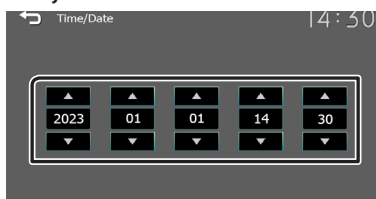

## 6 Toque [↵].

# Conceptos básicos

## Funciones de los botones del panel frontal

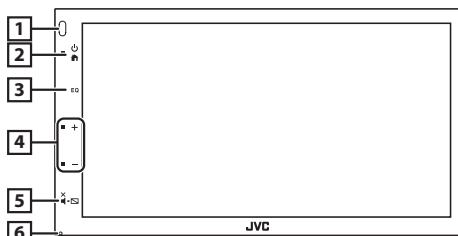

### 1 Sensor remoto

- Recibe la señal del control remoto.

### 2 (HOME)

- Muestra la pantalla INICIO. **(P.38)**
- Presione y mantenga en segundo se apaga la alimentación.
- Si la unidad está apagada, la enciende.

### 3 EQ

- Muestra la pantalla Audio.\* **(P.45)**
- \* La pantalla Audio no se visualiza durante la pantalla de configuración o en la pantalla de lista, etc.

### 4 +, - (Volume)

- Ajusta el volumen. Si continúa presionando [ + ] el volumen aumentará hasta 15.

### 5 (MUTE, Display off) (visualización desactivada)

- Silencia/restablece el sonido.
- Pulse and hold apaga la pantalla. Cuando la pantalla esté apagada, toque la pantalla para encender la misma.

### 6 Restablecer

- Si la unidad o el equipo conectado no funcionan correctamente, la unidad restablece la configuración de fábrica al pulsar este botón.

## Funciones habituales

### Encendido

- 1 Pulse el botón .



### Apagado

- 1 Pulse y mantenga pulsado el botón .

## Descripciones de la pantalla INICIO

- 1 Pulse el botón .



Aparece la pantalla HOME (inicio).

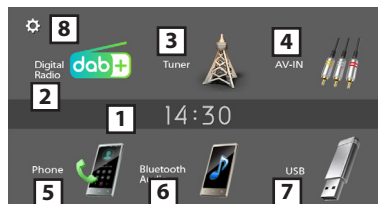

### 1 Pantalla del reloj

Toque para visualizar la pantalla Reloj.

### 2 Cambia a la emisión de radio digital. \* **(P.39)**

\* *KW-M180DBT solamente*

### 3 Cambia a la emisión del programa de radio **(P.40)**

### 4 Cambia a un componente externo conectado a la terminal de entrada AV-IN. **(P.43)**

### 5 Muestra la pantalla Manos libres. **(P.44)**

### 6 Reproduce un reproductor de audio Bluetooth. **(P.45)**

### 7 [USB]

Reproduce archivos en un dispositivo USB. **(P.41)**

### [iPhone]

Reproduce un iPhone. **(P.42)**

- Cuando está conectado un

### [Mirroring]

Muestra la pantalla Duplicación.

Cuando está conectado un dispositivo Android con la aplicación "Mirroring OB for JVC" instalada.

### 8 Muestra la pantalla CONFIGURACIÓN. **(P.37)**

## Pantalla de control de fuente



### 1 : Regresa a la pantalla anterior.

: Muestra la pantalla Audio. **(P.45)**

# Radio digital (KW-M180DBT)

## Funcionamiento básico de la radio digital

- 1 Pulse el botón <img alt="Home button icon" data-bbox="218 122 248 142"/>.
- 2 Toque [Digital Radio].

### Pantalla de control de fuente

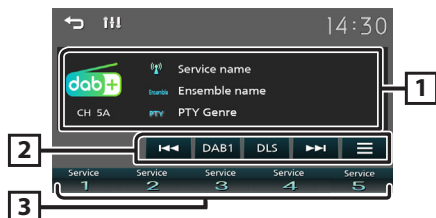

- 1 Muestra la información del servicio actual:  
Nombre del servicio, Nombre del conjunto,  
Género PTY, Canal
- 2 **[DAB]**: Cambia la banda predefinida de Radio digital.  
"DAB1", "DAB2", "DAB3"  
**[DLS]**: Visualice la pantalla Segmento de etiqueta dinámica.  
**[<img alt="Left arrow" data-bbox="100 478 120 498"/> <img alt="Right arrow" data-bbox="140 478 160 498"/>]**: Seleccione un conjunto, un servicio y un componente.  
**[<img alt="Menu icon" data-bbox="100 508 120 528"/>]**: Muestra la pantalla Configuración de la radio digital. **(P.39)**
- 3 Restaura el servicio memorizado.  
Si se toca durante 2 segundos, almacena en la memoria el servicio de recepción actual.

### Almacenar un servicio

El servicio que se está recibiendo actualmente puede almacenarse en la memoria.

- 1 Sintonice el servicio que desea preestablecer.
- 2 Mantenga pulsado el [#] (#:1-5) en el que desee guardar el servicio.

### Seleccionar un servicio almacenado

- 1 Toque [#] (#:1-5).

## Configuración de la radio digital

- 1 Toque [].
- 2 Ajuste cada elemento del modo siguiente.

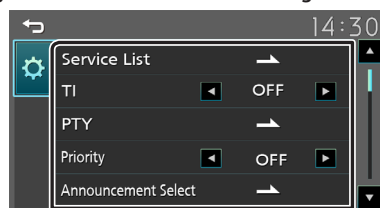

### **[Service List]**

Muestra la pantalla Lista de servicios.

- []: Toque y luego toque [YES] para encontrar la lista de servicios más reciente.

### **[TI]**

Cambia a la información de tráfico automáticamente cuando empieza el boletín de tráfico.

"ON", "OFF" (predeterminado)

### **[PTY]**

Busca un programa por tipo de programa.

### **[Priority]**

Si se ofrece el mismo servicio por sistema de datos de radio cuando la recepción por radio digital empeora, se cambia automáticamente a sistema de datos de radio.

"ON", "OFF" (predeterminado)

### **[Announcement Select]**

Cambia al servicio de anuncio seleccionado.

### **[Related Service]**

Al seleccionar ON (encendido), la unidad cambia a un servicio relacionado (si existe) cuando una red de servicio DAB no esté disponible. La opción predeterminada es "OFF".

### **[Antenna Power]**

Ajusta la alimentación de la antena de radio digital. Seleccione "ON" si la antena de radio digital que utiliza está equipada con amplificador. La opción predeterminada es "ON".

- 3 Toque [].

# Tuner

## Manejo básico de radio

1 Pulse el botón <MENU>.

2 Toque [Radio].

### ■ Pantalla de control de fuente

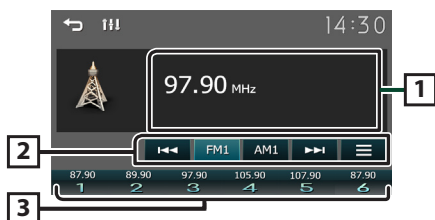

1 Muestra información sobre la emisora actual: Nombre PS, Frecuencia, Género PTY, Elementos del indicador

2 **[FM]** : Cambia a la banda FM.

"FM1", "FM2", "FM3"

**[AM]** : Cambia a la banda AM.

"AM1", "AM2"

**[<<] [>>]** : Sintoniza automáticamente una emisora con buena recepción.

Pulse y mantenga presionado para cambiar a la siguiente frecuencia manualmente

**[≡]** : Preajusta emisoras automáticamente. (P.40)

3 Restaura la emisora memorizada.

Si se toca durante 2 segundos, almacena en la memoria la emisora de recepción actual.

## Emisoras preestablecidas

### ■ Memoria automática

Se pueden preestablecer 6 emisoras para la banda actual (FM1/FM2/FM3/AM1/AM2).

1 Toque **[FM]** o **[AM]** para seleccionar la frecuencia.

2 Toque [≡].

3 Toque [Auto Store].

Las emisoras locales con las señales más fuertes se encuentran y almacenan automáticamente.

### ■ Memoria manualy

Puede almacenar en la memoria la emisora que está recibiendo actualmente.

1 Sintonice una emisora que desea preestablecer.

2 Mantenga pulsado [#] (#:1-6) en el que desee guardar la emisora.

### ■ Volver a una emisora prefijada

1 Toque [#] (#:1-6).

## Configuración de radio

1 Toque [≡].

2 Ajuste cada elemento del modo siguiente.

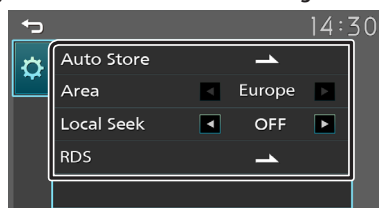

### [Auto Store]

Busca y guarda automáticamente las 6 emisoras con las señales más fuertes de la banda seleccionada. Aparece "Auto Store".

### [Area]

"Europe" : Intervalos AM/FM: 9 kHz/50 kHz.

### [Local Seek]

Sintoniza solo las emisoras con una fuerza de señal suficiente. (Se ilumina el indicador **LOC**). "ON" (ACTIVADO), "OFF" (DESACTIVADO) (predeterminado)

### [RDS] \*1

Muestra la pantalla Configuración de RDS.

### [AF]

Si la recepción de una emisora es deficiente, se cambia automáticamente a la emisora que esté emitiendo el mismo programa a través de la misma red de Radio Data System.

"ON" (ACTIVADO) (Predeterminado), "OFF" (DESACTIVADO)

### [TA]

Cambia a la información de tráfico automáticamente cuando empieza el boletín de tráfico. (Se ilumina el indicador **TI**).

"ON" (ACTIVADO), "OFF" (DESACTIVADO) (predeterminado)

### [RDS Clock Sync]

Sincronización mediante el Sistema de datos de radio de los datos horarios de la emisora y el reloj de esta unidad.

"ON" (ACTIVADO) (Predeterminado), "OFF" (DESACTIVADO)

### [PTY]

Seleccione un tipo de programa.

### [PTY Seek]

Busca un programa por tipo de programa.

\*1 Sólo en FM

3 Toque [↩].



# USB

## Preparativos

### Conexión de un dispositivo USB

- 1 Retire la tapa del terminal de USB.
- 2 Conecte el dispositivo USB con el cable USB.

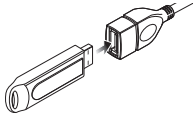

La unidad lee el dispositivo y se inicia la reproducción.

### Para desconectar el dispositivo USB:

- 1 Pulse el botón <img alt="botón de inicio" data-bbox="225 307 245 325"/>.
- 2 Toque una fuente distinta de [USB].
- 3 Desconecte el dispositivo USB.



### Dispositivos USB que pueden utilizarse

Esta unidad puede reproducir archivos MPEG1/ MPEG2/ MPEG4/ H.264/ MKV/ MP3/WMA/ AAC/ WAV/ FLAC/ OGG guardados en un dispositivo de clase de almacenamiento masivo USB. (P.51)

## Operaciones de reproducción

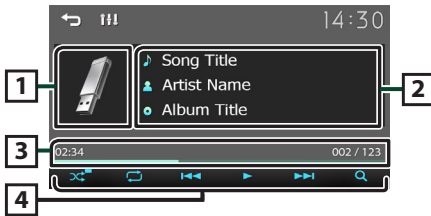
### Controle la música que está escuchando en la pantalla de control de fuente.



- 1 Se muestra la cubierta de la emisora que se está escuchando en ese momento.
- 2 Muestra la información del archivo actual.
- 3 Tiempo de reproducción/Número de archivo  
**Barra de tiempo de reproducción:** Para confirmar la posición actual de la reproducción.
- 4 []: Selecciona el modo Reproducción aleatoria.  
[]: Selecciona el modo de reproducción Repetir.  
[▶], [⏸]: Inicia la reproducción o hace una pausa.  
[◀], [▶]: Busca el contenido anterior siguiente.  
Mantenga pulsado para avanzar o retroceder rápidamente.  
[Q]: Busca el archivo.(P.41)

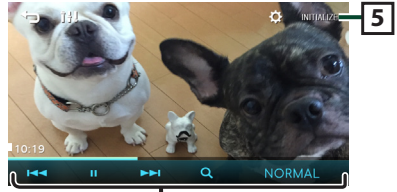

### Para la reproducción de video

- 1 Si los botones de operación no se visualizan en la pantalla, toque la pantalla.





- 5 []: Puede ajustar la calidad de imagen en la pantalla de vídeo.  
[INITIALIZE]: Para eliminar el ajuste.
- 6 [▶], [⏸]: Inicia la reproducción o hace una pausa.  
[◀], [▶]: Busca el contenido anterior siguiente.  
Mantenga pulsado para avanzar o retroceder rápidamente.  
[Q]: Busca el archivo. (P.41)  
[NORMAL]/[16:9]/[4:3]: Seleccione un modo de pantalla.

### Selección de una pista en una lista (búsqueda de archivo)

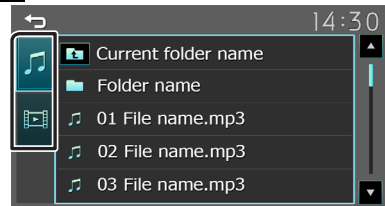
- 1 Toque [Q].
- 2 Seleccione si desea realizar la búsqueda por archivo de audio [, o por archivo de vídeo [].



- 3 Toque [] para desplazarse a la jerarquía superior.
- 4 Toque la carpeta deseada.  
Al tocar una carpeta, se muestran sus contenidos.  
• Toque [] para desplazarse a la jerarquía superior.
- 5 Toque para seleccionar el elemento en la lista de contenidos.  
La reproducción se inicia.

### NOTA

- Aparece la pantalla de control de la fuente cuando toca [] en la parte superior de la jerarquía.

## Preparativos

### Conexión de iPhone

- Para obtener detalles acerca de la conexión de un iPhone, consulte la página 50.

### 1 Retire la tapa del terminal de USB.

### 2 Conecte el iPhone.

La unidad lee el dispositivo y se inicia la reproducción.

### Para desconectar el iPhone

#### 1 Pulse el botón <img alt="Home button icon" data-bbox="225 258 245 275"/>.

#### 2 Toque una fuente distinta de [iPhone].

#### 3 Desconecte el iPhone.

### iPhone que pueden conectarse

Los siguientes modelos pueden conectarse a esta unidad.

Fabricados para

- |                              |                     |
|------------------------------|---------------------|
| • iPhone 14 Pro Max          | • iPhone 11 Pro Max |
| • iPhone 14 Pro              | • iPhone 11 Pro     |
| • iPhone 14 Plus             | • iPhone 11         |
| • iPhone 14                  | • iPhone XS Max     |
| • iPhone 13 Pro Max          | • iPhone XS         |
| • iPhone 13 Pro              | • iPhone XR         |
| • iPhone 13                  | • iPhone X          |
| • iPhone 13 mini             | • iPhone 8 Plus     |
| • iPhone 12 Pro Max          | • iPhone 8          |
| • iPhone 12 Pro              | • iPhone 7 Plus     |
| • iPhone 12                  | • iPhone 7          |
| • iPhone 12 mini             | • iPhone SE         |
| • iPhone SE (2nd generation) | • iPhone 6s Plus    |
|                              | • iPhone 6s         |

### NOTA

- Si empieza la reproducción después de conectar el iPhone, se reproducirá primero la música reproducida por el iPhone.
- Tape la terminal de USB cuando no se esté utilizando.

## Operaciones de reproducción







### Controle la música que está escuchando en la pantalla de control de fuente.



1 Material gráfico (se muestra si la pista contiene material gráfico)

2 Muestra la información del archivo actual.

3 Tiempo de reproducción/Número de archivo  
**Barra de tiempo de reproducción:** Para confirmar la posición actual de la reproducción.

- 4 [  ] : Selecciona el modo Reproducción aleatoria.  
[  ] : Selecciona el modo de reproducción Repetir.  
[  ], [  ] : Inicia la reproducción o hace una pausa.  
[  ], [  ] : Busca el contenido anterior siguiente.  
Mantenga pulsado para avanzar o retroceder rápidamente.  
[  ] : Busca contenido. (P.42)

### Seleccione un contenido en una lista

#### 1 Toque [Q].

#### 2 Toque el elemento deseado.

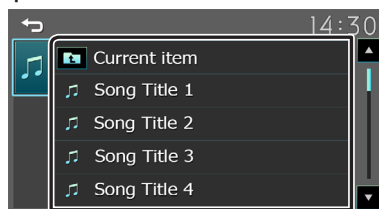

Cuando toca una categoría, se muestran sus contenidos.

#### 3 Toque para seleccionar el elemento en la lista de contenidos.

La reproducción se inicia.

- Toque [  ] para desplazarse a la jerarquía superior.

### NOTA

- Aparece la pantalla de control de la fuente cuando toca [  ] en la parte superior de la jerarquía.

# Componentes externos

## Uso de reproductores de audio/vídeo exteriores

### Inicio de la reproducción

- 1 Conecte un componente externo a la terminal de entrada AV-IN. (P.49)
- 2 Pulse el botón <img alt="Home button icon" data-bbox="218 188 248 203"/> .
- 3 Toque [AV-IN].
- 4 Enciende el componente conectado y comienza a reproducir la fuente.

### Para la reproducción de video

- 1 Si los botones de operación no se visualizan en la pantalla, toque la pantalla.

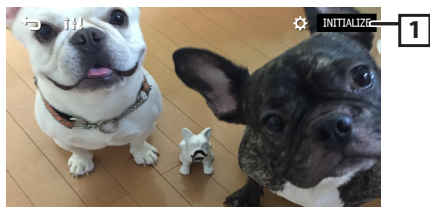

- 1  : Puede ajustar la calidad de imagen en la pantalla de vídeo.  
**[INITIALIZE]** : Para eliminar el ajuste.

#### NOTA

- Cuando la imagen de la cámara de visión trasera se visualiza en la pantalla AV-IN, la emisión de la imagen desde el terminal de salida de vídeo desaparece.

## Cámara de visión trasera

Para usar una cámara de visión trasera, se requiere la conexión del cable de MARCHA ATRÁS. Para conectar una cámara de visión trasera. (P.49)

### Visualización de la imagen desde la cámara de visión trasera

Se muestra la pantalla de visión trasera cuando cambia la palanca de cambios a la posición de marcha atrás (R).



- Toca la primera vez para eliminar la advertencia, y vuelve a tocar para cerrar la pantalla de la cámara.

## Función de aprendizaje del mando a distancia de la dirección

Esta función solo está disponible si su vehículo está equipado con el mando a distancia de la dirección eléctrica.

- 1 Pulse el botón <img alt="Home button icon" data-bbox="668 175 698 190"/> .
- 2 Toque [Settings].
- 3 Toque [System].
- 4 Toque [Steering Remote].
- 5 Toque la función que desea ajustar.
- 6 Mantenga pulsado el botón del mando a distancia de la dirección.

#### NOTA

- Puede hacer que la unidad aprenda todos los botones al mismo tiempo. Para ello, pulse todos los botones a la vez y, a continuación, toque  en la pantalla Configuración del mando a distancia de la dirección.

- 7 Repita los pasos 5 y 6 según sea necesario.



- 8 Toque  .

#### NOTA

- Toque [Initialize] y después toque [Yes] para establecer todos los ajustes en los ajustes iniciales predeterminados.

## Inverso con ATT (-20dB)

Ajusta el volumen de la unidad cuando la marcha se desplaza a la posición de marcha atrás (R) Presta atención

- 1 Pulse el botón <img alt="Home button icon" data-bbox="668 633 698 648"/> .
- 2 Toque [Settings].
- 3 Toque [System].
- 4 Toque [Reverse with ATT].
- 5 Toque [] or [] a [ON]/[OFF].

#### NOTA

- Establecer el valor a on (default)

# Bluetooth

## Registre su teléfono inteligente en la unidad

Puede utilizar su teléfono inteligente Bluetooth cuando esté emparejado con esta unidad.

- 1 Active la función Bluetooth en su teléfono inteligente/teléfono móvil.
- 2 Busque la unidad ("KW-M180BT"/"KW-M180BT") en su teléfono inteligente/teléfono móvil.

Si se requiere un código PIN, introduzca el código PIN ("0000").

-  aparece cuando el teléfono inteligente Bluetooth está conectado.

### Desconexión del dispositivo

- Desactive la función Bluetooth en su teléfono inteligente/teléfono móvil.
- Apague el interruptor de encendido.

## Reciba una llamada telefónica



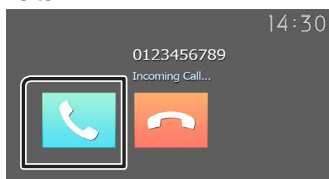

### 1 Toque .

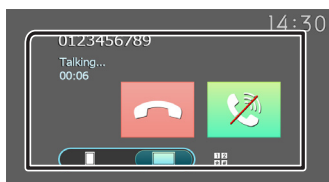

- : Rechace una llamada entrante.

### Operaciones durante una llamada



-  Finalización de una llamada
-  Silenciu voz
-  Puede enviar tonos tocando las teclas correspondientes de la pantalla.
  - Toque  para cerrar la ventana.
-  Cambia la salida de voz entre el teléfono inteligente/móvil y el altavoz.

### Ajustar el volumen del receptor

Pulse el botón <+> o <->.





## Realice una llamada telefónica

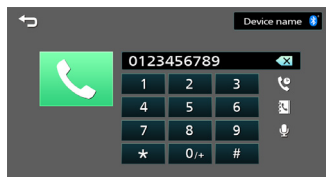



- 1 Pulse el botón  > .
- 2 Toque [Phone].
- 3 Consulte la tabla de abajo para cada método de funcionamiento..





### Llamar introduciendo un número telefónico

- 1) Introducir un número de teléfono con las teclas numéricas.
- 2) Toque .  
Haga una llamada
- Toque  para borrar la última entrada.

### Llamar usando datos de llamada almacenados





- 1) Toque .
- 2) Toque  (llamadas entrantes),  (llamadas salientes),  (llamadas perdidas).
- 3) Seleccione el número de teléfono de la lista.  
Haga una llamada

### Llamar usando la agenda telefónica

- 1) Toque .
- 2) Seleccione el nombre de la lista.  
Haga una llamada
  - : Actualiza la agenda. Toque este botón después de que haya realizado un cambio en la agenda de su teléfono inteligente/móvil.

### Llamada esperando

Cuando recibe una nueva llamada mientras estás en una llamada:

- 1) Toque  la llamada actual está en espera y podrá responder a la llamada recién recibida.
- 2) Cada vez que tocas , la llamada actual cambia a otra llamada.
- 3) Si toca  mientras está en llamada en espera, se rechaza la llamada.
- 4) Si toca , la llamada actual termina y cambia a la llamada en espera.
- 5) Toque  para silenciarte.

## Bluetooth

### Reproducir dispositivos de audio Bluetooth

1 Pulse el botón <🏠> .

2 Toque [Bluetooth Audio].

📱 Pantalla de control de fuente

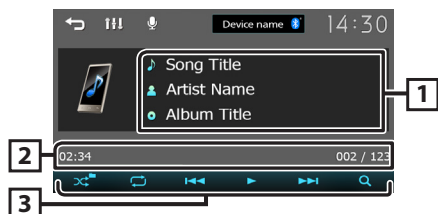

1 Muestra la información del archivo actual.

2 Tiempo de reproducción/Número de archivo  
**Barra de tiempo de reproducción:** Para confirmar la posición actual de la reproducción.

3 [🔀]: Selecciona el modo Reproducción aleatoria.  
[🔁]: Selecciona el modo de reproducción Repetir.  
[▶], [⏸]: Reproduce o pausa.  
[⏮], [⏭]: Busca el contenido anterior/siguiente.  
Mantenga pulsado para avanzar o retroceder rápidamente.  
[🔍]: Busca el archivo. **(P.45)**

📎 NOTA

• Las operaciones y las indicaciones en pantalla pueden variar en función de su disponibilidad en el dispositivo conectado.

📱 Seleccione un contenido en una lista

1 Toque [Q].

2 Toque el elemento deseado.

Cuando toca una categoría, se muestran sus contenidos.

3 Toque para seleccionar el elemento en la lista de contenidos.

La reproducción se inicia.

• Toque [↶] para desplazarse a la jerarquía superior.

📎 NOTA

• Aparece la pantalla de control de la fuente cuando toca [↷] en la parte superior de la jerarquía.

## Control del audio

Puede configurar diversos ajustes como el balance del audio o el nivel del subwoofer.

1 Pulse el botón <EQ> .

2 Consulte lo siguiente para cada método de funcionamiento.

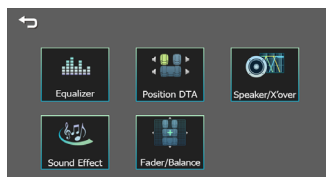

### Controlar el audio general

1 Pulse el botón <EQ> .

2 Toque [Fader / Balance].

3 Ajuste cada elemento del modo siguiente.

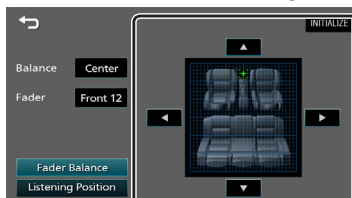

[Fader Balance]

**Balance** Ajuste el balance del volumen izquierdo y derecho.  
[◀] [▶]  
De 15 (izquierda) a 15 (derecha)

**Fader** Ajuste el balance del volumen delantero y trasero.  
[▲] [▼]  
De 15 (delantero) a 15 (trasero)

[INITIALIZE] Para eliminar el ajuste.

[Listening Position]

[●] Seleccione una posición de escucha entre "Front Left", "Front All", "Front Right" y "Middle".

[INITIALIZE] Para eliminar el ajuste.

# Instalación

## Antes de la instalación

Antes de la instalación de esta unidad, tenga en cuenta las precauciones siguientes.

### ▲ADVERTENCIAS

- Si conecta el cable de encendido (rojo) y el cable de la batería (amarillo) al chasis del automóvil (tierra), podría producir un cortocircuito y esto, a su vez, un incendio. Conecte siempre esos cables a la fuente de alimentación que pasa por la caja de fusibles.
- No corte el fusible del cable de ignición (rojo) y el cable de la batería (amarillo). El suministro de energía debe conectarse a los cables por medio del fusible.

### ▲PRECAUCIÓN

- Instale esta unidad en la consola de su vehículo. No toque la parte metálica de esta unidad durante e inmediatamente después del uso de la unidad. Las partes metálicas, tales como el dissipador de calor o la carcasa, pueden estar muy calientes.

### NOTA

- La instalación y el cableado de este producto requieren habilidad y experiencia. Para mayor seguridad, deje el trabajo de montaje y cableado en manos de profesionales.
- Asegúrese de utilizar para la unidad una fuente de alimentación de 12 V CC con conexión a tierra negativa.
- No instale la unidad en un sitio expuesto a la luz directa del sol, o excesivamente húmedo o caluroso. Además deberá evitar sitios con mucho polvo o con posibilidad de salpicaduras de agua.
- No utilice sus propios tornillos. Utilice solo los tornillos suministrados. El uso de tornillos diferentes podría causar daños en la unidad.
- Si el encendido de su automóvil no está provisto de la posición ACC, conecte los cables de encendido a una fuente de alimentación que pueda conectarse y desconectarse con la llave de encendido. Si conecta el cable de encendido a una fuente de alimentación con un suministro de voltaje constante, como con los cables de la batería, la batería puede agotarse.
- Si la consola tiene una tapa, asegúrese de instalar la unidad de forma que el panel frontal no golpee la tapa al abrirse o cerrarse.
- Si se funden los fusibles, asegúrese primero de que los cables no están en contacto pues pueden ocasionar un cortocircuito, luego reemplace el fusible dañado por uno nuevo que tenga la misma potencia de servicio.
- Aísle los cables no conectados con una cinta de vinilo u otro material similar. Para evitar cortocircuitos, no retire las tapas de los extremos de los cables o terminales no conectados.

- Asegure los cables con las abrazaderas de cable y envuelva cinta de vinilo alrededor de los cables que entren en contacto con los elementos metálicos para proteger los cables y para evitar cortocircuitos.
- Conecte los cables de los altavoces a cada uno de los terminales correspondientes. La unidad se puede dañar o no funcionar si comparte los cables ⊖ o los conecta a tierra a cualquier parte metálica del vehículo.
- Si se han conectado solamente dos altavoces al sistema, enchufe los conectores a ambos terminales de salida delanteros o a ambos terminales de salida traseros (es decir, no mezcle terminales delanteros y traseros). Por ejemplo, si conecta el conector ⊕ del altavoz izquierdo a un terminal de salida delantero, no conecte el conector ⊖ a un terminal de salida posterior.
- Después de instalar la unidad, compruebe que las luces de freno, las luces intermitentes, el limpiaparabrisas, etc. funcionan satisfactoriamente.
- Instale la unidad en un ángulo de 30° o menos.
- No presione con fuerza la superficie del panel al instalar la unidad en el vehículo. De lo contrario, pueden producirse marcas, daños o fallos.
- La recepción podría ser baja si existen objetos metálicos cerca de la antena Bluetooth.

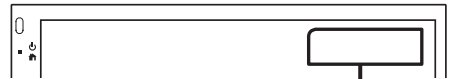

Unidad de antena Bluetooth

## Instalación

### ■ Accesorios suministrados para la instalación

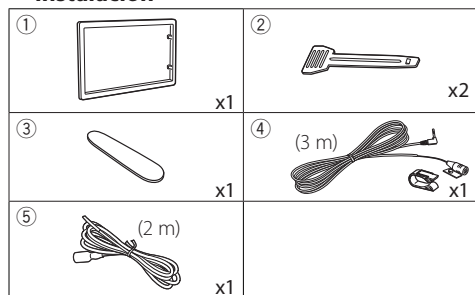

### ■ Procedimiento de instalación

- 1) Para evitar cortocircuitos, retire la llave del encendido y desconecte el terminal  $\ominus$  de la batería.
- 2) Realice de forma adecuada las conexiones de cables de entrada y salida para cada unidad.
- 3) Conecte el cable al mazo de conductores.
- 4) Tome el conector B en el mazo de cables y conéctelo al conector de altavoz de su vehículo.
- 5) Tome el conector A en el mazo de cables y conéctelo al conector de alimentación externa de su vehículo.
- 6) Conecte el mazo de cables a la unidad.
- 7) Instale la unidad en el automóvil.
- 8) Conecte nuevamente el terminal  $\ominus$  de la batería.
- 9) Pulse el botón Restablecer.

### Instalación de la unidad

#### ■ Coches no japoneses

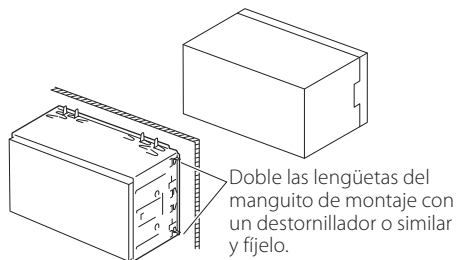

#### NOTA

- Asegúrese de que la unidad esté firmemente instalada en su lugar. Si la unidad está en una posición inestable, es posible que no funcione correctamente (por ejemplo, el sonido puede interrumpirse).

#### ■ Placa de montaje

- 1) Conecte el accesorio ① a la unidad.

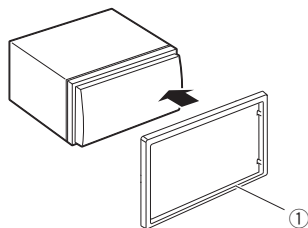

## Instalación

### ■ Unidad de micrófono

- 1) Compruebe la posición de instalación del micrófono (accesorio ④).
- 2) Limpie la superficie de instalación.
- 3) Extraiga el separador del micrófono (accesorio ④) y fije el micrófono en la posición indicada más abajo.
- 4) Conecte el cable del micrófono a la unidad de forma segura en varias posiciones mediante cinta u otro método.
- 5) Ajuste la dirección del micrófono (accesorio ④) hacia el conductor.

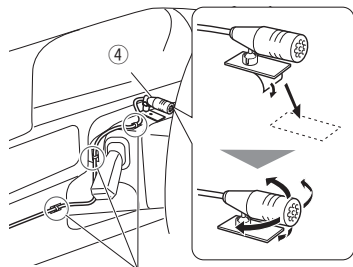

Fije un cable con una cinta adhesiva de uso comercial.

### NOTA

- Cambie los clips si es necesario.

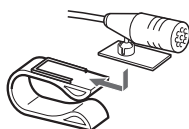

### ■ Retirada del marco

- 1) Use la tecla de extracción (accesorio ③) para extraer las cuatro pestañas (dos en la parte izquierda, dos en la parte derecha).

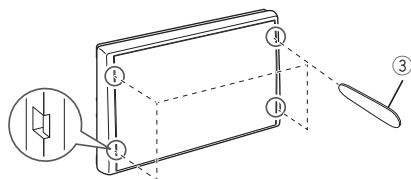

- 2) Pull the trim plate forward.

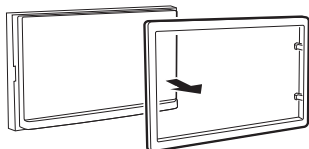

### ■ Desmontaje de la unidad

- 1) Retire el marco según las indicaciones del paso 1 de "Retirada del marco".
- 2) Introduzca la llave de extracción (accesorio ②) profundamente en la ranura tal y como se muestra. (El saliente en la punta de la tecla de extracción debe mirar hacia la unidad).

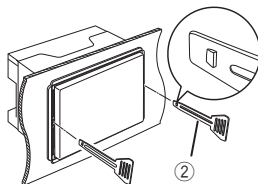

- 3) Con la llave de extracción introducida asegurada, inserte la otra llave de extracción en la ranura.

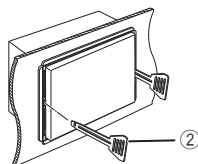

- 4) Saque la unidad hasta la mitad.

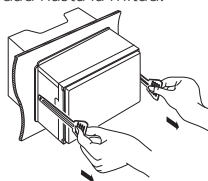

### NOTA

- Tenga cuidado de no hacerse daño con los pasadores de bloqueo de la llave de extracción.
- 5) Termine de sacar la unidad con las manos, prestando atención para no dejarla caer.

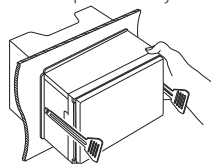



# Instalación

## Conectar los cables a los terminales

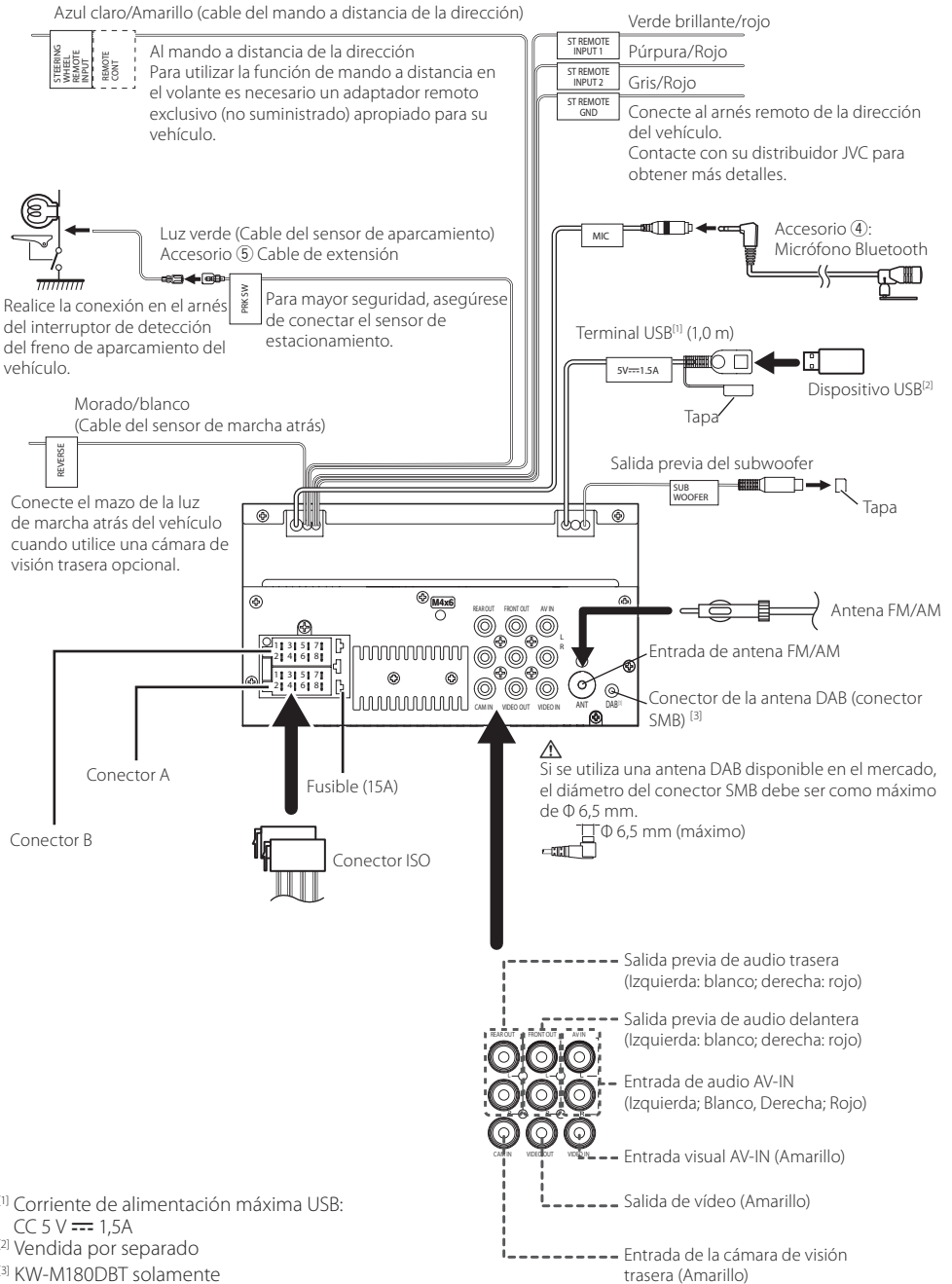

<sup>[1]</sup> Corriente de alimentación máxima USB:

CC 5 V ± 1,5A

<sup>[2]</sup> Vendida por separado

<sup>[3]</sup> KW-M180DBT solamente

## Instalación

### Guía de funciones de los conectores del mazo de cables

Patilla	Color y función	
A-4	Amarillo	Batería
A-5	Azul/Blanco <sup>[1]</sup>	Control de alimentación
A-7	Rojo	Encendido (ACC)
A-8	Negro	Conexión a tierra (masa)
B-1/ B-2	Púrpura (+) / Púrpura/Negro (-)	Trasero derecho
B-3/ B-4	Gris (+) / Gris/Negro (-)	Delantero derecho
B-5/ B-6	Blanco (+) / Blanco/Negro (-)	Delantero izquierdo
B-7/ B-8	Verde (+) / Verde/Negro (-)	Trasero izquierdo

<sup>[1]</sup> Máx. 150 mA, 12 V

- Impedancia del altavoz: 4-8 Ω

### ⚠ PRECAUCIÓN

Antes de conectar los conectores ISO disponibles comercialmente a la unidad, compruebe la siguiente condición:

- Asegúrese de que la asignación de clavijas del conector coincida con la unidad JVC
- Tome precauciones extra con el cable de alimentación.
- In caso de que el cable de la batería y el cable de encendido no correspondan, entonces cámbielos según corresponda.
- En caso de que el coche no tenga un cable de encendido, use una interfaz disponible comercialmente.

### Conexión de un iPhone/Android

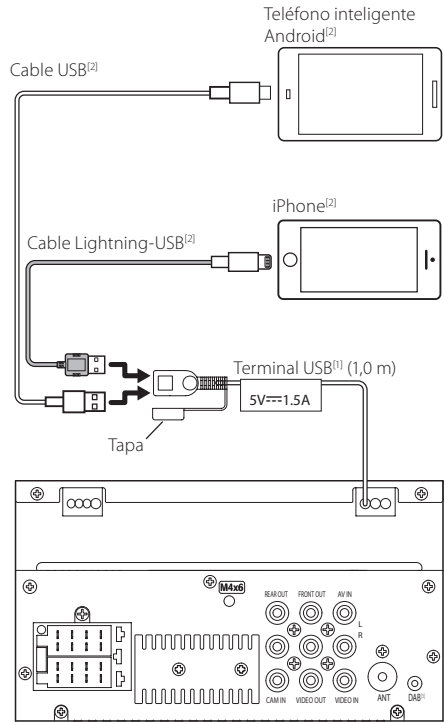

<sup>[1]</sup> Corriente de alimentación máxima USB:  
CC 5 V --- 1,5A

<sup>[2]</sup> Se vende por separado

<sup>[3]</sup> KW-M180DBT solamente

# Acerca de esta unidad

## Más información

### Dispositivos USB que pueden utilizarse

Esta unidad puede reproducir archivos MPEG1/ MPEG2/ MPEG4/H.264/MKV/ MP3/WMA/ AAC/ WAV/ FLAC/ OGG guardados en un dispositivo de almacenamiento masivo USB.

- Sistema de archivo: FAT16 / FAT32 / NTFS / exFAT
- Esta unidad puede reconocer un total de 9.999 archivos y 320 carpetas (un máximo de 9.999 archivos por carpeta).
- El número máximo de caracteres:
- Nombres de carpeta: 70 caracteres
- Nombres de archivo: 70 caracteres
- Etiqueta: 70 caracteres

### NOTA

- Cuando el dispositivo USB esté conectado a esta unidad, puede cargarse a través del cable USB.
- Instale el dispositivo USB en un lugar que no perjudique a una conducción segura.
- No puede conectar un dispositivo USB mediante un núcleo USB o un lector de tarjetas múltiple.
- Haga copias de seguridad de los archivos de audio utilizados con esta unidad. Los archivos podrían borrarse en función de las condiciones de funcionamiento del dispositivo USB. No compensaremos en forma alguno los daños producidos por cualquier dato borrado.
- Esta unidad no se suministra con un dispositivo USB. Tiene que comprar un dispositivo USB disponible comercialmente.
- Tape la terminal de USB cuando no se esté utilizando.

### Archivos de audio reproducibles

Formato de audio	Tasa de bits/ (Recuento de bits)	Frecuencia de muestreo
MP3 (.mp3)	16 – 320kbps, VBR	16 – 48 kHz
WMA (.wma)	16 – 320kbps	16 – 48 kHz
AAC-LC (.m4a)	16 – 320kbps	16 – 48 kHz
Linear PCM (WAVE) (.wav)	(16/24 bit)	8 – 192 kHz
FLAC (.flac)	(16/24 bit)	8 – 192 kHz
Vorbis (.ogg)	(16/24 bit)	8 – 192 kHz

- Esta unidad puede mostrar etiquetas ID3 Versión 1.0/1.1/2.2/2.3/2.4 (para MP3).

### NOTA

- Los formatos WMA y AAC que están cubiertos con DRM no pueden reproducirse.

- Aunque los archivos de audio cumplen los estándares anteriores, puede que no sea posible la reproducción según los tipos o condiciones del medio o dispositivo.

### Archivos de vídeo aceptados

Formato de vídeo	Códec de vídeo	Códec de audio
MPEG-1 (.mpg, .mpeg)	MPEG-1	MPEG Audio Layer 2
MPEG-2 (.mpg, .mpeg)	MPEG-2	MPEG Audio Layer 2
MPEG-4 (.mp4, .avi)	MPEG-4 (SP,ASP)	MP3, AAC-LC (2ch)
H.264/MPEG-4 AVC (.mp4, mkv, avi, .flv, .f4v)	H.264/MPG-4 AVC (BP/MP/HP)	MP3, AAC (2ch)
MKV (.mkv)	Video Format follows H.264/ MPEG-4 AVC, MPEG4, XVID	MP3, AAC, Vorbis, FLAC

## Especificaciones

### Sección de Bluetooth

Frecuencia  
: 2,4 – 2,48 GHz

RF Output Power (E.I.R.P.)  
: +8dBm (MAX)

### Sección de audio

Impedancia del altavoz  
: 4 – 8 Ω

### General

Voltaje de funcionamiento  
: Batería de coche de 12 V CC

## Acerca de esta unidad

### Derechos de autor

- La marca denominativa y los logos de Bluetooth® son marcas registradas propiedad de Bluetooth SIG, Inc. y cualquier uso de dichas marcas por JVCKENWOOD Corporation está sujeto a los términos de licencia. El resto de marcas comerciales y nombres comerciales corresponden a sus respectivos propietarios.
- Use of the Made for Apple badge means that an accessory has been designed to connect specifically to the Apple product(s) identified in the badge and has been certified by the developer to meet Apple performance standards. Apple is not responsible for the operation of this device or its compliance with safety and regulatory standards. Please note that the use of this accessory with an Apple product may affect wireless performance.
- Apple, iPhone and Lightning are trademarks of Apple Inc., registered in the U.S. and other countries.
- Android is a trademark of Google LLC.
- Microsoft and Windows Media are either registered trademarks or trademarks of Microsoft Corporation in the United States and/or other countries.
- THIS PRODUCT IS LICENSED UNDER THE MPEG-4 VISUAL PATENT PORTFOLIO LICENSE FOR THE PERSONAL AND NON-COMMERCIAL USE OF A CONSUMER FOR (i) ENCODING VIDEO IN COMPLIANCE WITH THE MPEG-4 VISUAL STANDARD ("MPEG-4 VIDEO") AND/OR (ii) DECODING MPEG-4 VIDEO THAT WAS ENCODED BY A CONSUMER ENGAGED IN A PERSONAL AND NON-COMMERCIAL ACTIVITY AND/OR WAS OBTAINED FROM A VIDEO PROVIDER LICENSED BY MPEG LA TO PROVIDE MPEG-4 VIDEO. NO LICENSE IS GRANTED OR SHALL BE IMPLIED FOR ANY OTHER USE. ADDITIONAL INFORMATION INCLUDING THAT RELATING TO PROMOTIONAL, INTERNAL AND COMMERCIAL USES AND LICENSING MAY BE OBTAINED FROM MPEG LA, LLC. SEE [HTTP://WWW.MPEGLA.COM](http://www.MPEGLA.COM).
- THIS PRODUCT IS LICENSED UNDER THE AVC PATENT PORTFOLIO LICENSE FOR THE PERSONAL USE OF A CONSUMER OR OTHER USES IN WHICH IT DOES NOT RECEIVE REMUNERATION TO (i) ENCODE VIDEO IN COMPLIANCE WITH THE AVC STANDARD ("AVC VIDEO") AND/OR (ii) DECODE AVC VIDEO THAT WAS ENCODED BY A CONSUMER ENGAGED IN A PERSONAL ACTIVITY AND/OR WAS OBTAINED FROM A VIDEO PROVIDER LICENSED TO PROVIDE AVC VIDEO. NO LICENSE IS GRANTED OR SHALL BE IMPLIED FOR ANY OTHER USE. ADDITIONAL INFORMATION MAY BE OBTAINED FROM MPEG LA, L.L.C. SEE [HTTP://WWW.MPEGLA.COM](http://www.MPEGLA.COM)
- libFLAC  
Copyright (C) 2000-2009 Josh Coalsón  
Copyright (C) 2011-2013 Xiph.Org Foundation
  - Redistribution and use in source and binary forms, with or without modification, are permitted provided that the following conditions are met:
  - Redistributions of source code must retain the above copyright notice, this list of conditions and the following disclaimer.

– Redistributions in binary form must reproduce the above copyright notice, this list of conditions and the following disclaimer in the documentation and/or other materials provided with the distribution.

Neither the name of the Xiph.org Foundation nor the names of its contributors may be used to endorse or promote products derived from this software without specific prior written permission.

THIS SOFTWARE IS PROVIDED BY THE COPYRIGHT HOLDERS AND CONTRIBUTORS "AS IS" AND ANY EXPRESS OR IMPLIED WARRANTIES, INCLUDING, BUT NOT LIMITED TO, THE IMPLIED WARRANTIES OF MERCHANTABILITY AND FITNESS FOR A PARTICULAR PURPOSE ARE DISCLAIMED. IN NO EVENT SHALL THE FOUNDATION OR CONTRIBUTORS BE LIABLE FOR ANY DIRECT, INDIRECT, INCIDENTAL, SPECIAL, EXEMPLARY, OR CONSEQUENTIAL DAMAGES (INCLUDING, BUT NOT LIMITED TO, PROCUREMENT OF SUBSTITUTE GOODS OR SERVICES; LOSS OF USE, DATA, OR PROFITS; OR BUSINESS INTERRUPTION) HOWEVER CAUSED AND ON ANY THEORY OF LIABILITY, WHETHER IN CONTRACT, STRICT LIABILITY, OR TORT (INCLUDING NEGLIGENCE OR OTHERWISE) ARISING IN ANY WAY OUT OF THE USE OF THIS SOFTWARE, EVEN IF ADVISED OF THE POSSIBILITY OF SUCH DAMAGE.

#### • libogg

Copyright (c) 2002, Xiph.org Foundation Redistribution and use in source and binary forms, with or without modification, are permitted provided that the following conditions are met:

– Redistributions of source code must retain the above copyright notice, this list of conditions and the following disclaimer.

– Redistributions in binary form must reproduce the above copyright notice, this list of conditions and the following disclaimer in the documentation and/or other materials provided with the distribution.

– Neither the name of the Xiph.org Foundation nor the names of its contributors may be used to endorse or promote products derived from this software without specific prior written permission.

THIS SOFTWARE IS PROVIDED BY THE COPYRIGHT HOLDERS AND CONTRIBUTORS "AS IS" AND ANY EXPRESS OR IMPLIED WARRANTIES, INCLUDING, BUT NOT LIMITED TO, THE IMPLIED WARRANTIES OF MERCHANTABILITY AND FITNESS FOR A PARTICULAR PURPOSE ARE DISCLAIMED. IN NO EVENT SHALL THE FOUNDATION OR CONTRIBUTORS BE LIABLE FOR ANY DIRECT, INDIRECT, INCIDENTAL, SPECIAL, EXEMPLARY, OR CONSEQUENTIAL DAMAGES (INCLUDING, BUT NOT LIMITED TO, PROCUREMENT OF SUBSTITUTE GOODS OR SERVICES; LOSS OF USE, DATA, OR PROFITS; OR BUSINESS INTERRUPTION) HOWEVER CAUSED AND ON ANY THEORY OF LIABILITY, WHETHER IN CONTRACT, STRICT LIABILITY, OR TORT (INCLUDING NEGLIGENCE OR OTHERWISE) ARISING IN ANY WAY OUT OF THE USE OF THIS SOFTWARE, EVEN IF ADVISED OF THE POSSIBILITY OF SUCH DAMAGE.

# Índice

Antes de utilizar.....	53
Como ler este manual.....	53
Precauções.....	53
Primeiros Passos.....	54
Definições do Relógio.....	54
Básicos.....	55
Funções dos botões no painel frontal.....	55
Operações comuns.....	55
Ecrã de INÍCIO.....	55
Ecrã de controlo da fonte.....	55
Rádio Digital.....	56
Operação Básica do Rádio Digital.....	56
Configuração do Rádio Digital.....	56
Rádio.....	57
Operação básica do Sintonizador.....	57
Estações de predefinição.....	57
Configuração de Sintonizador.....	57
USB.....	58
Preparativos.....	58
Operações de reprodução.....	58
iPhone.....	59
Preparativos.....	59
Operações de reprodução.....	59
Componentes Externos.....	60
Utilizar leitores de áudio/vídeo externos.....	60
Câmara de vista traseira.....	60
Função de aprendizagem do comando de direcção.....	60
Inverter com ATT.....	60
Bluetooth.....	61
Registe o seu smartphone na unidade.....	61
Receber uma chamada.....	61
Fazer uma chamada.....	61
Reproduzir um dispositivo de áudio Bluetooth.....	62
Controlar o Áudio.....	62
Controlar o áudio geral.....	62
Instalação.....	63
Antes da instalação.....	63
Instalar a unidade.....	64
Sobre esta unidade.....	68
Mais informação.....	68
Especificações.....	68
Direitos de autor.....	69

- Para operações e informações detalhadas, consulte o MANUAL DE INSTRUÇÕES no seguinte website:

<<https://www.jvc.net/cs/car/>>.



# Antes de utilizar

## Como ler este manual

- Os painéis mostrados neste manual são exemplos utilizados para dar explicações claras sobre as operações. Por esta razão, poderão ser diferentes dos painéis reais.
- Nos procedimentos de operação, os parênteses indicam a tecla ou o botão que deve pressionar.
  - < >: indica o nome de botões de painel.
  - [ ]: indica o nome de teclas de toque

 Este símbolo no produto significa que há instruções importantes de operação e manutenção neste manual. Certifique-se de ler cuidadosamente as instruções neste manual.

## Precauções

### ADVERTÊNCIA

#### Para evitar lesões ou um incêndio, tome as seguintes precauções:

- Para evitar um curto-circuito, nunca coloque ou deixe objetos metálicos (como moedas ou ferramentas) dentro da unidade.
- Não veja nem fixe os olhos no visor da unidade quando está a conduzir por longos períodos.
- Se aparecerem problemas durante a instalação, consulte o seu concessionário JVC

#### Precauções de utilização desta unidade

- Quando comprar acessórios opcionais, confirme junto do representante JVC que eles funcionam com o seu modelo e na sua zona.
- Você pode seleccionar um idioma para exibir menus, tags de arquivos de áudio, etc. Ver **Primeiros Passos (P.54)**
- A função Radio Data System (Sistema dados rádio) ou Radio Broadcast não funciona onde o serviço não é suportado por nenhuma estação de difusão.

#### Proteger o monitor

- Para proteger o monitor de danos, não opere o monitor utilizando uma esferográfica ou um objeto semelhante com ponta afiada.

#### Limpar a unidade

Se o painel frontal da unidade estiver manchado, limpe-o com um pano macio e seco como um pano de silicone. Se a painel frontal estiver muito manchado, limpe a mancha com um pano humedecido com detergente neutro e, de seguida, limpe-o com um pano seco.

### ATENÇÃO

- A aplicação direta de spray de limpeza na unidade poderá afetar as respetivas peças mecânicas. Limpar o painel frontal com um pano que não seja macio ou usando um líquido volátil, como diluente ou álcool, pode riscar a superfície ou apagar caracteres.

#### Como reiniciar a unidade

Se a unidade ou a unidade ligada não funcionar corretamente, reinicialize-a.

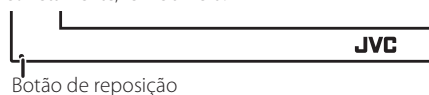

Botão de reposição

# Primeiros Passos

## 1 Rode a chave de ignição do seu carro para ACC.

A unidade está ligada, leia o aviso e pressione "Concordar" para entrar na tela.



## 2 Pressione o botão <img alt="Home button icon" data-bbox="250 268 285 285"/>.

## 3 Toque em [Settings].

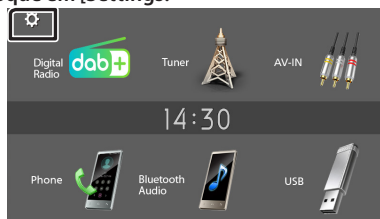

## 4 Toque na tecla correspondente e defina o valor.

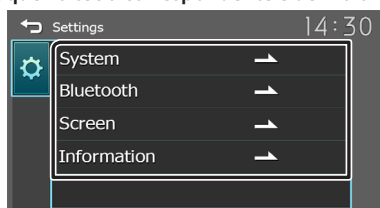

### [System]

#### [Beep Tone]

Ativa ou desativa o tom de toque das teclas. "ON" (Padrão), "OFF"

#### [Language]

Selecione o idioma utilizado para o ecrã de controlo e os itens de definição. A predefinição é "English" (Inglês).

#### [Time/Date]

Ajuste a hora do relógio. (P.54)

#### [Clock Mode]

Selecione o formato de apresentação da hora. [12hr] / [24hr] (Padrão)

#### [Steering Remote]

Define a função desejada no controle remoto da direção. Ver **Função de aprendizagem do comando (P.60)**

#### [Parking Guidelines]

É possível visualizar as orientações de estacionamento para facilitar o estacionamento quando for engatada a marcha-atrás (R). A predefinição é "ON".

### [Guidelines SETUP]

Se seleccionar [ON] para [Parking Guidelines], pode ajustar as orientações de estacionamento.

### [Reverse with ATT (-20dB)]

Quando a engrenagem é deslocada para a posição inversa (R), o volume do dispositivo é ajustado. O padrão é "ON". **Consulte Para ajustar o inverso com ATT (P.60)**

### [System Reset]

Toque em [System Reset] e, em seguida, toque em [YES] para definir todas as definições para as predefinições iniciais.

### [Bluetooth]

Apresenta o ecrã de Definições do Bluetooth. (P.61).

### [Screen]

#### [Dimmer]

Selecione o modo de gradação.

"High" (Padrão) / "Mid" / "Low"

#### [Demo]

Selecione o modo de demonstração. A predefinição é "ON".

### [Information]

Exibe a versão do software e o número do modelo desta unidade

## 5 Toque em [↩].

## Definições do Relógio

### ■ Sincronização da hora do relógio com o FM RDS

Ative [RDS Clock Sync].

Consulte a secção **Configuração de Rádio (P.57)**.

### ■ Ajustar o relógio manualmente

📎 NOTA

- Desative [RDS Clock Sync] antes de acertar o relógio.

## 1 Pressione o botão <img alt="Home button icon" data-bbox="695 662 730 679"/>.

## 2 Toque em [Settings].

## 3 Toque em [System].

## 4 Toque em [Time/Date].

É apresentado o ecrã Relógio.

## 5 Toque em [▲] ou [▼] para acertar a hora do relógio.

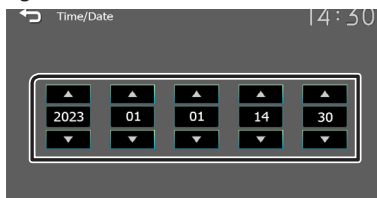

## 6 Toque em [↩].

# Básicos

## Funções dos botões no painel frontal

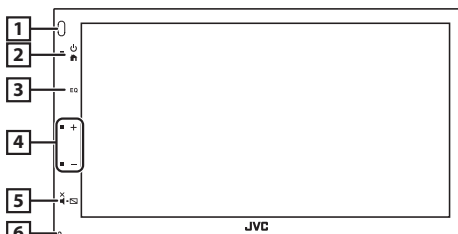

### 1 Sensor Remoto

- Recebe o sinal do controlo remoto.

### 2 (HOME)

- Apresenta o ecrã inicial. **(P.55)**
- Se pressionado durante 1 segundo, desliga a alimentação.
- Quando a alimentação está desligada, liga a alimentação.

### 3 EQ

- Apresenta o ecrã de Áudio.\* **(P.62)**
- \* O ecrã de Áudio não é exibido no ecrã CONFIGURAÇÃO ou no ecrã da lista, etc.

### 4 +, - (Volume)

- Ajusta o volume. O volume vai até ao nível 15 quando premir [ + ] continuamente.

### 5 (MUTE, Display off) (Ecrã desligado)

- Silencia/restaura o som.
- Se premido durante 1 segundo, desliga o ecrã. Quando o ecrã estiver desligado, toque no visor para ligar o ecrã.

### 6 Repor

- Se a unidade ou a unidade ligada não funcionar corretamente, esta repõe as definições iniciais quando este botão é pressionado.

## Operações comuns

### Ligar a alimentação

1 Pressione o botão > .



### Desligar a alimentação

1 Pressione e segure o botão > .

## Ecrã de INÍCIO

1 Pressione o botão > .



Aparece o ecrã HOME (inicial).



1 Mostrador de Relógio

2 Muda para a transmissão de rádio digital.\* **(P.56)**  
\* **KW-M180DBT apenas**

3 Muda para a emissão de rádio. **(P.57)**

4 Muda para um componente externo conectado ao terminal de entrada AV-IN. **(P.60)**

5 Mostra o ecrã Mãos Livres. **(P.61)**

6 Reproduz de um leitor de áudio Bluetooth. **(P.62)**

7 **[USB]**

Reproduz ficheiros num dispositivo USB. **(P.58)**

**[iPhone]**

Reproduz um iPhone. **(P.59)**

- Quando está conectado um iPhone.

**[Mirroring]**

Exibe o ecrã de Espelhamento.

- Quando estiver conectado um dispositivo Android com a aplicação "Mirroring OB for JVC" instalada.

8 Apresenta o ecrã CONFIGURAÇÃO **(P.54)**

## Ecrã de controlo da fonte



1 : Volta para o ecrã original.

: Apresenta o ecrã de Áudio. **(P.62)**

# Rádio Digital (KW-M180DBT)

## Operação Básica do Rádio Digital

- 1 Pressione o botão .
- 2 Toque em [Digital Radio].

### Ecrã de controlo da fonte

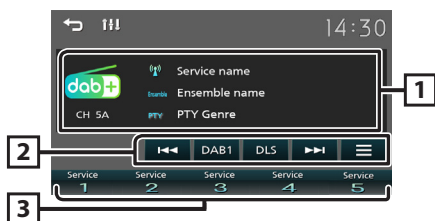

- 1 Mostra a informação sobre o serviço atual:  
Nome do serviço, Nome do conjunto, Género de PTY, Canal

- 2 **[DAB]**: Muda a banda predefinida do Rádio Digital.  
"DAB1", "DAB2", "DAB3"  
**[DLS]**: Exibe o ecrã de Segmento de Etiqueta Dinâmica  
**[◀▶]**: Selecione um conjunto, serviço e componente.  
**[☰]**: Apresenta o ecrã de Configuração do Rádio Digital. **(P.56)**

- 3 Chama o serviço memorizado.  
Se tocar na tecla durante 2 segundos, guarda na memória o serviço atual a ser recebido no momento.

### Armazene um serviço

Pode guardar na memória o serviço atual a ser recebido.

- 1 Sintonize num serviço que queira predefinir.
- 2 Toque e mantenha pressionado [#] (#:1-5) em que pretende armazenar o serviço.

### Selecione um serviço armazenado

- 1 Toque em [#] (#:1-5).

## Configuração do Rádio Digital

- 1 Toque em .
- 2 Defina cada item da seguinte forma.

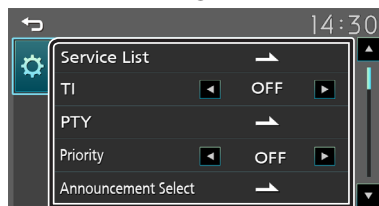

### [Service List]

Apresenta o ecrã de Lista de Serviço.

- : Toque e depois toque em [Yes] para encontrar a lista de serviços mais recente.

### [TI]

Muda automaticamente para a informação de trânsito quando começa o boletim de trânsito.  
"ON", "OFF" (Padrão)

### [PTY]

Procura um programa por tipo de programa.

### [Priority]

Se o mesmo serviço for fornecido pelo sistema de dados de rádio quando a receção do serviço fornecida pelo rádio digital se tornar deficiente, muda automaticamente para o sistema de dados de rádio.

"ON", "OFF" (Padrão)

### [Announcement Select]

Muda para o serviço de declaração definido.

### [Related Service]

Quando seleciona ON (Ligar), a unidade comuta para um serviço relacionado (se existir) quando a rede do serviço DAB não está disponível. A predefinição é "OFF".

### [Antenna Power]

Define a alimentação da antena do rádio digital. Definido em "ON" quando a antena do rádio digital em utilização está equipada com um amplificador. A predefinição é "ON".

- 3 Toque em .



# Sintonizador

## Operação básica do sintonizador

1 Pressione o botão <🏠> .

2 Toque em [Radio].

📱 **Ecrã de controlo da fonte**

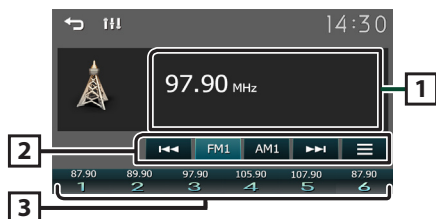

1 Mostra a informação sobre a estação atual: Nome PS, Frequência, Género PTY, Itens de Indicador

2 **[FM]** : Muda a banda FM.

“FM1”, “FM2”, “FM3”

**[AM]** : Muda a banda AM.

“AM1”, “AM2”

**[◀▶]** : Sintoniza automaticamente uma estação com boa receção.

**[☰]** : Apresenta o ecrã de Configuração do Rádio. **(P.57)**

3 Chama a estação memorizada.

Se tocar na tecla durante 2 segundos, guarda na memória a estação atual a ser recebida no momento.

## Estações de predefinição

📱 **Memória automática**

Pode predefinir 6 estações para a banda atual (FM1/FM2/FM3/AM1/AM2).

1 Toque em **[FM]** ou **[AM]** para selecionar a banda.

2 Toque em **[☰]**.

3 Toque em **[Auto Store]**.

As estações locais com sinais mais fortes são automaticamente encontradas e armazenadas.

📱 **Memória manual**

Pode guardar na memória a estação atual a ser recebida.

1 Sintonize numa estação que queira predefinir.

2 Toque e mantenha pressionado **[#]** (#:1-6) em que pretende armazenar a estação.

📱 **Recuperar a estação predefinida**

1 Toque em **[#]** (:#:1-6).

## Configuração do sintonizador

1 Toque em **[☰]**.

2 Defina cada item da seguinte forma.

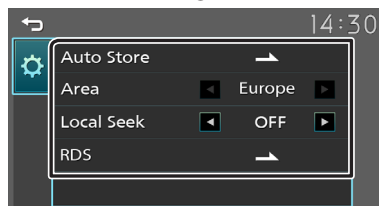

**[Auto Store]**

Procura e guarda automaticamente as 6 estações com o sinal mais forte para a banda selecionada. “Auto Store” aparece.

**[Area]**

“Europe”: Intervalos AM/FM: 9 kHz/50 kHz.

**[Local Seek]**

Sintoniza apenas nas estações com força de sinal suficiente. (O indicador **LOC** acende-se.)

“ON”, “OFF” (Padrão)

**[RDS]\*1**

Apresenta o ecrã de Definições RDS.

**[AF]**

Quando a receção de uma estação é deficiente, muda automaticamente para a estação que está a transmitir o mesmo programa, na mesma rede Radio Data System (RDS).

“ON” (Padrão), “OFF”

**[TA]**

Muda automaticamente para a informação de trânsito quando começa o boletim de trânsito. (O indicador **TI** acende-se.)

“ON”, “OFF” (Padrão)

**[RDS Clock Sync]**

Sincronizar a hora da estação do Sistema de Dados de Rádio e o relógio desta unidade.

“ON” (Padrão), “OFF”

**[PTY]**

Selecione um tipo de programa.

**[PTY Seek]**

Procura um programa por tipo de programa.

\*1 Apenas FM

3 Toque em **[↶]**.

# USB

## Preparativos

### ■ Conectar a um dispositivo USB

- 1 Remova a tampa do terminal USB.
- 2 Ligue o dispositivo USB com o cabo USB.

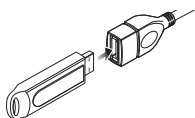

A unidade lê o dispositivo e inicia a reprodução.

### ■ Para desligar o dispositivo USB:

- 1 Pressione o botão <img alt="botão de desligar USB" data-bbox="265 295 285 315"/> .
- 2 Toque numa fonte diferente de [USB].
- 3 Desligue o dispositivo USB.





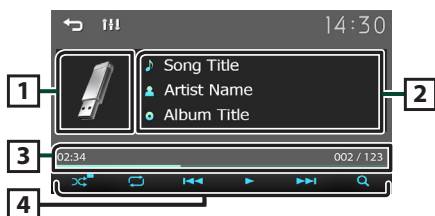

### ■ Compatibilidade com dispositivos USB

Esta unidade consegue reproduzir ficheiros MPEG1/ MPEG2/ MPEG4/ H.264/ MKV/ MP3/ WMA/ AAC/ WAV/ FLAC/ OGG armazenados num dispositivo USB de armazenamento em massa. **(P.68)**

## Operações de reprodução

### ■ Controle a música que está a ouvir no ecrã de controlo das fontes.







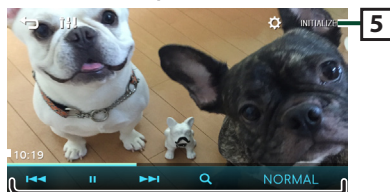

- 1 A capa do ficheiro a tocar é exibida.
- 2 Mostra a informação sobre o ficheiro atual.
- 3 Tempo de reprodução/Número de ficheiro  
Barra de tempo de reprodução : Para confirmação da posição de reprodução atual.
- 4  : Seleciona o modo de Reprodução aleatória.  
 : Seleciona o modo de Reprodução em repetição.  
,  : Reproduz ou pausa.  
,  : Procura o conteúdo anterior/ seguinte.  
Toque sem soltar para avançar rapidamente ou retroceder rapidamente.  
 : Procura o ficheiro. **(P.58)**



### ■ Para reprodução de Vídeo

- 1 Quando os botões de operação não forem exibidos no ecrã, toque no ecrã.





- 5  : Pode ajustar a qualidade de imagem no ecrã do vídeo.  
**[INITIALIZE]** : Para limpar o ajuste.
- 6 ,  : Reproduz ou pausa.  
,  : Procura o conteúdo anterior/ seguinte.  
Toque sem soltar para avançar rapidamente ou retroceder rapidamente.  
 : Procura o ficheiro. **(P.58)**  
**[NORMAL]/[16:9]/[4:3]** : Seleccione um modo de ecrã.

### ■ Selecionar uma faixa numa lista (Procurar o ficheiro)

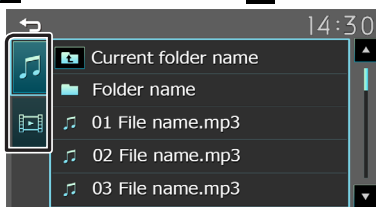
- 1 Toque em  .
- 2 Seleccione se quer procurar ficheiros de áudio  ou ficheiros de vídeo .



- 3 Toque em  para se deslocar para a hierarquia superior.
- 4 Toque na pasta pretendida.  
Quando toca numa pasta os seus conteúdos são apresentados.  
• Toque em  para se deslocar para a hierarquia superior.
- 5 Toque no item pretendido da lista de conteúdos.  
Inicia-se a reprodução.

#### 📎 NOTA

- O ecrã de controlo da fonte aparece quando toca em , na hierarquia superior.

# iPhone

## Preparativos

### Conectar a iPhone

- Para detalhes sobre conectar a iPhone, consulte a página 67.

#### 1 Remova a tampa do terminal USB.

#### 2 Ligue o iPhone.

A unidade lê o dispositivo e inicia a reprodução.

### Para desconectar o iPhone

#### 1 Pressione o botão <🏠> .

#### 2 Toque numa fonte diferente de [iPhone].

#### 3 Desligue o cabo do iPhone.

### Compatibilidade iPhone

Os seguintes modelos podem ser ligados a esta unidade.

Feito para

- iPhone 14 Pro Max
- iPhone 14 Pro
- iPhone 14 Plus
- iPhone 14
- iPhone 13 Pro Max
- iPhone 13 Pro
- iPhone 13
- iPhone 13 mini
- iPhone 12 Pro Max
- iPhone 12 Pro
- iPhone 12
- iPhone 12 mini
- iPhone SE (2nd generation)
- iPhone 11 Pro Max
- iPhone 11 Pro
- iPhone 11
- iPhone XS Max
- iPhone XS
- iPhone XR
- iPhone X
- iPhone 8 Plus
- iPhone 8
- iPhone 7 Plus
- iPhone 7
- iPhone SE
- iPhone 6s Plus
- iPhone 6s

### NOTA

- Se iniciar a reprodução depois de ligar o iPhone, a música que estava a ser reproduzida pelo iPod é reproduzida primeiro.
- Coloque a tampa no terminal USB quando não o estiver a utilizar.

## Operações de reprodução

### Controle a música que está a ouvir no ecrã de controlo das fontes.

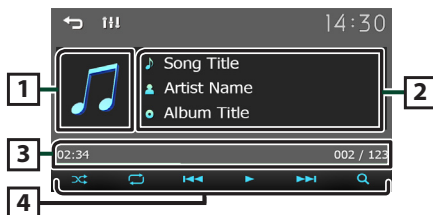

1 Capa (Mostrado se a faixa contiver capa de álbum)

2 Mostra a informação sobre o ficheiro atual.

3 Tempo de reprodução/Número de ficheiro

**Barra de tempo de reprodução :** Para confirmação da posição de reprodução atual.

4 [⏮]: Seleciona o modo de Reprodução aleatória.

[🔍]: Seleciona o modo de Reprodução em repetição.

[▶], [⏸]: Reproduz ou pausa.

[⏪], [⏩]: Procura o conteúdo anterior/ seguinte.

Toque sem soltar para avançar rapidamente ou retroceder rapidamente.

[🔍]: Procura o conteúdo. **(P.59)**

### Selecionar conteúdos numa lista

#### 1 Toque em [🔍].

#### 2 Toque no item pretendido.

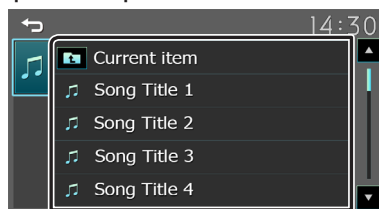

Quando toca numa categoria, os seus conteúdos são apresentados.

#### 3 Toque no item pretendido da lista de conteúdos.

Inicia-se a reprodução.

- Toque em [🏠] para se deslocar para a hierarquia superior.

### NOTA

- O ecrã de controlo da fonte aparece quando toca em [🏠], na hierarquia superior.

# Componentes Externos

## Utilizar leitores de áudio/vídeo externos

### ■ Iniciar a reprodução

- 1 Conecte um componente externo ao terminal de entrada AV-IN. (P.66)
- 2 Pressione o botão <img alt="Home button icon" data-bbox="250 180 280 200"/>.
- 3 Toque em [AV-IN].
- 4 Ligue o componente conectado e inicie a reprodução da fonte.

### ■ Para reprodução de Vídeo

- 1 Quando os botões de operação não forem exibidos no ecrã, toque no ecrã.

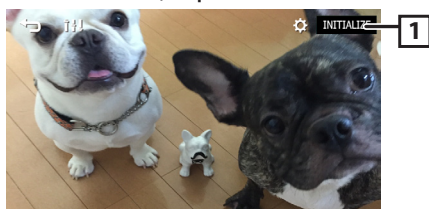

- 1 : Pode ajustar a qualidade de imagem no ecrã do vídeo.

[INITIALIZE]: Para limpar o ajuste.

### 📎 NOTA

- Quando a imagem da câmara de visualização traseira é exibida no ecrã AV-IN, a imagem do terminal da Saída Visual desaparece.

## Câmara de vista traseira

Para usar uma câmara de vista traseira, é necessária a conexão de guia REVERSE. Para conectar uma câmara de vista traseira. (P.66)

### ■ Apresentar a imagem a partir da câmara de vista traseira

O ecrã de vista traseira é exibido quando for engatada a marcha-atrás (R).



- O primeiro toque remove o Cuidado e o segundo toque fecha a Tela da Câmera

## Função de aprendizagem do comando de direcção

Esta função só está disponível quando o seu veículo está equipado com o comando remoto da direcção elétrica.

- 1 Pressione o botão <img alt="Home button icon" data-bbox="695 170 725 190"/>
- 2 Toque em [Settings].
- 3 Toque em [System].
- 4 Toque em [Steering Remote].
- 5 Toque na função que deseja definir.
- 6 Pressione e segure o botão do controle remoto da direcção.

### 📎 NOTA

- Você pode ter a unidade aprendida todos os botões de cada vez. Nesse caso, pressione todos os botões um de cada vez e depois de pressionar todos eles, toque em <img alt="Right arrow button icon" data-bbox="605 380 635 400"/> na tela Configuração do Controle Remoto de Direcção.

- 7 Repita os passos 5 e 6 conforme necessário.

- 8 Toque em <img alt="Right arrow button icon" data-bbox="605 445 635 465"/>.

### 📎 NOTA

- Toque em [Inicializar] e, em seguida, toque em [Sim] para definir todas as definições para as definições predefinidas iniciais.

## Inverter com ATT (-20dB)

Quando a engrenagem é deslocada para a posição inversa (R), o volume do dispositivo é ajustado.

- 1 Pressione o botão <img alt="Home button icon" data-bbox="695 615 725 635"/>
- 2 Toque em [Settings].
- 3 Toque em [System].
- 4 Toque em [Reverse with ATT].
- 5 Toque em [◀] ou [▶] definir como [ON]/[OFF].

### 📎 NOTA

- O valor de configuração está ligado (por omissão)

# Bluetooth

## Registe o seu smartphone na unidade

Pode utilizar o seu smartphone com Bluetooth quando estiver emparelhado com esta unidade.

**1 Ligue a função Bluetooth no seu smartphone/telemóvel.**

**2 Procure a unidade ("KW-M180DBT"/"KW-M180BT") a partir do seu smartphone/telemóvel.**

Se for necessário um código PIN, introduza o código PIN ("0000").

-  aparece quando o Bluetooth do smartphone está conectado.

### Desligar o dispositivo

- Desligue a função Bluetooth no seu smartphone/telemóvel.
- Desligue a ignição.

## Receber uma chamada

**1 Toque em .**

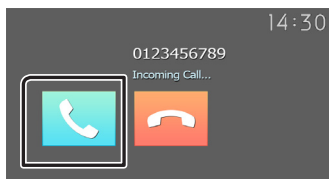

- : Rejeite uma chamada recebida.

### Operações durante uma chamada

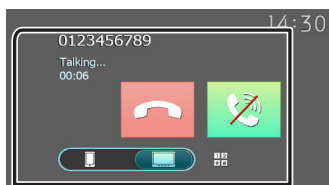

 Terminar uma chamada

 Pode enviar tonalidades, tocando nas teclas correspondentes no ecrã.

- Toque em  para fechar a janela.

 Alterna a saída de voz entre o smartphone/telemóvel e o altifalante.

 Switches the speaking voice output between smartphone/cell-phone and speaker.

• **Ajustar o volume do recetor**

Pressione o botão <+> ou <->.

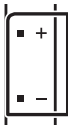

## Fazer uma chamada



**1 Pressione o botão .**

**2 Toque em [Phone].**

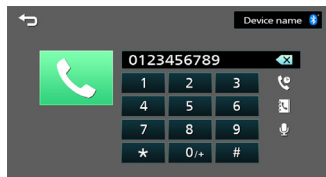



**3 Consulte a seguinte tabela para cada método de operação.**





### Ligar introduzindo um número de telefone

- 1) Introduza um número de telefone, utilizando as teclas numéricas.
- 2) Toque em .  
Faça uma chamada
- Toque em  para eliminar a última entrada.

### Ligar utilizando registos de chamadas





- 1) Toque em .
- 2) Toque em  (Chamadas Recebidas),  (Chamadas Efetuadas),  (Chamadas Perdidas).
- 3) Selecionar o número de telefone a partir da lista.  
Faça uma chamada

### Ligar utilizando a lista telefónica

- 1) Toque em .
- 2) Seleccione o nome a partir da lista.  
Faça uma chamada
- : Atualiza a lista telefónica. Toque neste botão depois de ter feito uma alteração na lista telefónica do seu smartphone/telemóvel.

## Chamada à espera

Quando você recebe uma nova chamada enquanto fala ao telefone:

- 1) Toque em , a chamada atual é colocada em espera e você pode atender a chamada recém-recebida.
- 2) Cada vez que você tocar em , o chamador mudará para o outro.
- 3) Se tocar em  durante a chamada em espera, rejeite uma chamada recebida.
- 4) Se você tocar em , quando alguém estiver em espera, a chamada atual terminará sendo switched para a chamada aguardando em espera.
- 5) Toque  silencie sua voz.

## Bluetooth

### Reproduzir um dispositivo de áudio Bluetooth

- 1 Pressione o botão <🏠> .
- 2 Toque em [Bluetooth Audio].

#### 📱 Ecrã de controlo da fonte

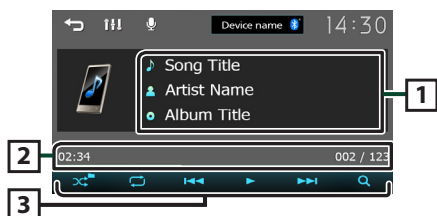

- 1 Mostra a informação sobre o ficheiro atual.
- 2 Tempo de reprodução/Número de ficheiro  
Barra de tempo de reprodução : Para confirmação da posição de reprodução atual.

- 3 [🔀] : Seleciona o modo de Reprodução aleatória.  
[🔄] : Seleciona o modo de Reprodução em repetição.  
[▶], [⏸] : Reproduz ou pausa.  
[⏮], [▶] : Procura o conteúdo anterior/seguinte.  
Toque sem soltar para avançar rapidamente ou retroceder rapidamente.  
[🔍] : Procura o ficheiro. (P.62)

#### 📎 NOTA

- As indicações de operação e exibição podem diferir de acordo com sua disponibilidade no dispositivo conectado.

#### 📁 Selecionar conteúdos numa lista

- 1 Toque em [🔍] .
- 2 Toque no item pretendido.  
Quando toca numa categoria, os seus conteúdos são apresentados.
- 3 Toque no item pretendido da lista de conteúdos.  
Inicia-se a reprodução.
  - Toque em [🏠] para se deslocar para a hierarquia superior.

#### 📎 NOTA

- O ecrã de controlo da fonte aparece quando toca em [🏠], na hierarquia superior.

## Controlar o Áudio

Pode ajustar várias definições, como o balanço áudio ou o nível de subwoofer.

- 1 Pressione o botão <EQ> .
- 2 Consulte o seguinte para cada método de operação.

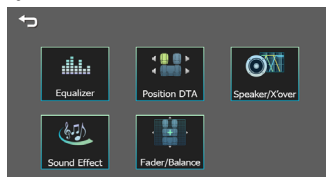

### Controlar o áudio geral

- 1 Pressione o botão <EQ> .
- 2 Toque em [Fader / Balance].
- 3 Defina cada item da seguinte forma.

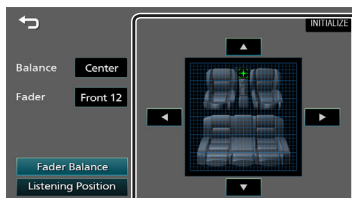

#### [Fader Balance]

**Balance** [◀] [▶]  
Ajuste o equilíbrio do volume à esquerda e à direita.  
15 (esquerda) a 15 (direita)

**Fader** [▲] [▼]  
Ajuste o equilíbrio do volume à frente e atrás.  
15 (frente) a 15 (trás)

[INITIALIZE] Para limpar o ajuste.

#### [Listening Position]

[●]  
Selecione uma posição de escuta entre "Front Left", "Front All", "Front Right" e "Middle".

[INITIALIZE] Para limpar o ajuste.

# Instalação

## Antes da instalação

Antes da instalação desta unidade, tenha em consideração as seguintes precauções.

### ▲ AVISOS

- Se ligar o fio de ignição (vermelho e o fio da bateria (amarelo) ao chassis do automóvel (terra), pode causar um curto-circuito, que por sua vez pode causar um incêndio. Ligue esses fios sempre à fonte de energia que passa através da caixa de fusíveis.
- Não elimine o fusível do cabo de ignição (vermelho) e do cabo da bateria (amarelo). A fonte de alimentação deve ser ligada aos cabos passando pelo fusível.

### ▲ CUIDADO

- Instale este aparelho na consola do seu automóvel. Não toque nas peças de metal deste aparelho durante ou pouco depois da utilização do aparelho. As peças de metal, como por exemplo a armação, aquecem.

### NOTA

- A instalação e ligação deste aparelho requerem conhecimentos e experiência. Para maior segurança, deixe as operações de montagem e ligação a cargo de profissionais.
- Assegure-se de que liga a unidade a uma fonte de alimentação de 12 V CC com massa negativa.
- Não instale o aparelho num local exposto à luz solar direta ou calor e humidade excessivos. Evite também locais com demasiada poeira ou a possibilidade de salpicos de água.
- Não utilize os seus próprios parafusos. Utilize apenas os parafusos fornecidos. O uso de parafusos não apropriados pode resultar em danos ao aparelho principal.
- Se a ignição do automóvel não tiver uma posição ACC, conecte os fios da ignição a uma fonte de energia que possa ser ativada e desativada pela chave de ignição. Se ligar o fio de ignição a uma fonte de alimentação com um débito de tensão permanente, como os cabos da bateria, a bateria poderá ficar descarregada.
- Se a consola tiver tampa, certifique-se que instala o aparelho de forma a que o painel frontal não bata na tampa ao abrir e ao fechar.
- Se o fusível fundir, certifique-se primeiro de que os fios não tocam uns nos outros para não causar um curto-circuito, e substitua o fusível antigo por outro com a mesma potência.
- Isole os cabos não ligados com fita isolante ou outro material similar. Para evitar curtos-circuitos,

não remova as capas dos finais dos cabos não conectados ou dos terminais.

- Fixe os fios com grampos de cabos e envolva uma fita de vinil em torno dos fios que entrem em contacto com peças metálicas para proteger os fios e evitar curto-circuito.
- Ligue os cabos individuais do altifalante aos terminais correspondentes. A unidade poderá ficar danificada ou deixar de funcionar se partilhar os fios ⊖ ou os ligar à massa a qualquer peça metálica do carro.
- Quando houver somente dois altifalantes conectados ao sistema, ligue os conectores a ambos os terminais de saída frontais ou a ambos os terminais de saída traseiros (não misture terminais frontais com traseiros). Por exemplo, se ligar o conector ⊕ do altifalante esquerdo a um terminal de saída dianteiro, não ligue o conector ⊖ a um terminal de saída traseiro.
- Depois que a unidade tiver sido instalada, verifique se as lâmpadas de stop, os pisca-piscas, os limpa pára-brisa, etc. do automóvel estão funcionando corretamente.
- Monte o aparelho de forma a que o ângulo de montagem seja de 30° ou menos.
- Não faça muita pressão sobre a superfície do painel quando instalar a unidade no automóvel. Caso contrário poderão resultar marcas, danos ou avarias.
- A receção poderá ser reduzida se existirem objetos metálicos próximos da antena Bluetooth.

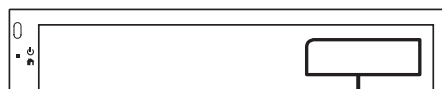

Unidade da antena Bluetooth

## Instalação

### ■ Acessórios fornecidos para instalação

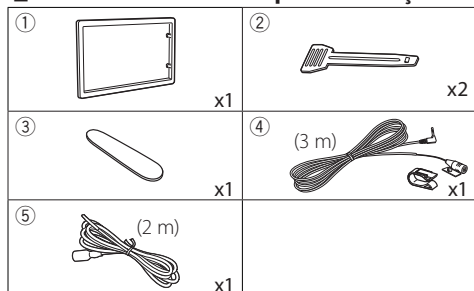

### ■ Método de instalação

- 1) Para prevenir um curto-circuito, remova a chave da ignição e desligue o terminal  $\ominus$  da bateria.
- 2) Faça as ligações apropriadas dos cabos de entrada e saída de cada unidade.
- 3) Ligue o fio à cablagem.
- 4) Ligue o conector B da cablagem ao conector do altifalante do seu veículo.
- 5) Ligue o conector A da cablagem ao conector de energia externa do seu veículo.
- 6) Ligue o conector da cablagem à unidade.
- 7) Instale o aparelho no seu carro.
- 8) Volte a ligar o terminal  $\ominus$  da bateria.
- 9) Pressione o botão de reposição.

### Instalar a unidade

#### ■ Carros não-japoneses

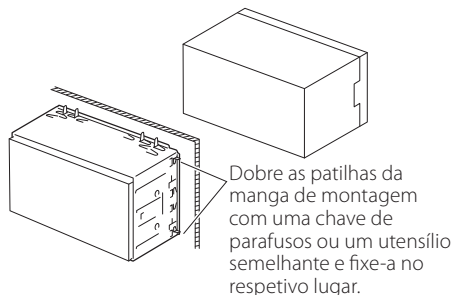

#### NOTA

- Certifique-se de que a unidade está firmemente instalada na posição adequada. Se a unidade estiver instável, poderá funcionar incorretamente (por exemplo, com falhas no som).

#### ■ Moldura

- 1) Anexar acessório ① à unidade.

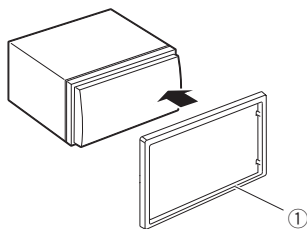



# Instalação

## ■ Unidade do microfone

- 1) Verifique a posição de instalação do microfone (acessório ④).
- 2) Limpe a superfície de instalação.
- 3) Retire o separador do microfone (acessório ④) e coloque o microfone na placa apresentada abaixo.
- 4) Ligue o cabo do microfone na unidade, prendendo-o em várias posições com fita adesiva ou outro método.
- 5) Ajuste a direção do microfone (acessório ④) ao condutor.

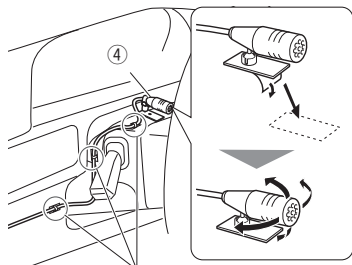

Fixe um cabo com fita adesiva.

### NOTA

- Se necessário, troque os cliques.



## ■ Retirar a moldura

- 1) Use a chave de extração (acessório ③) para levantar as quatro abas (duas na parte esquerda e duas na parte direita).

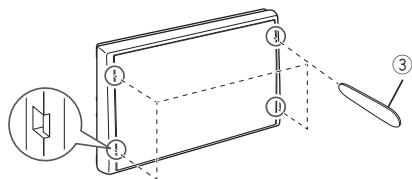

- 2) Puxe a moldura para a frente.

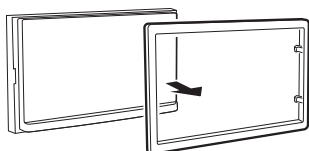

## ■ Retirar a unidade

- 1) Retire a moldura seguindo o passo 1 em "Retirar a moldura".
- 2) Insira a chave de extração (acessório ②) profundamente na ranhura, conforme mostrado. (A saliência na ponta da chave de extração deve estar virada para a unidade.)

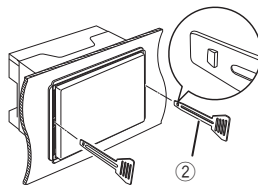

- 3) Com a chave de extração inserida segura, insira a outra chave de extração na ranhura.

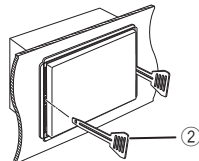

- 4) Puxe a unidade para fora até meio.

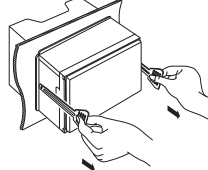

### NOTA

- Tenha cuidado para não se ferir com os pinos de retenção da chave de remoção.
- 5) Puxe a unidade totalmente para fora, com as mãos, tendo cuidado para não a deixar cair.

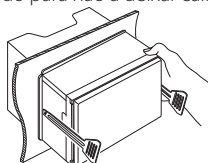

# Instalação

## ■ Ligar os cabos aos terminais

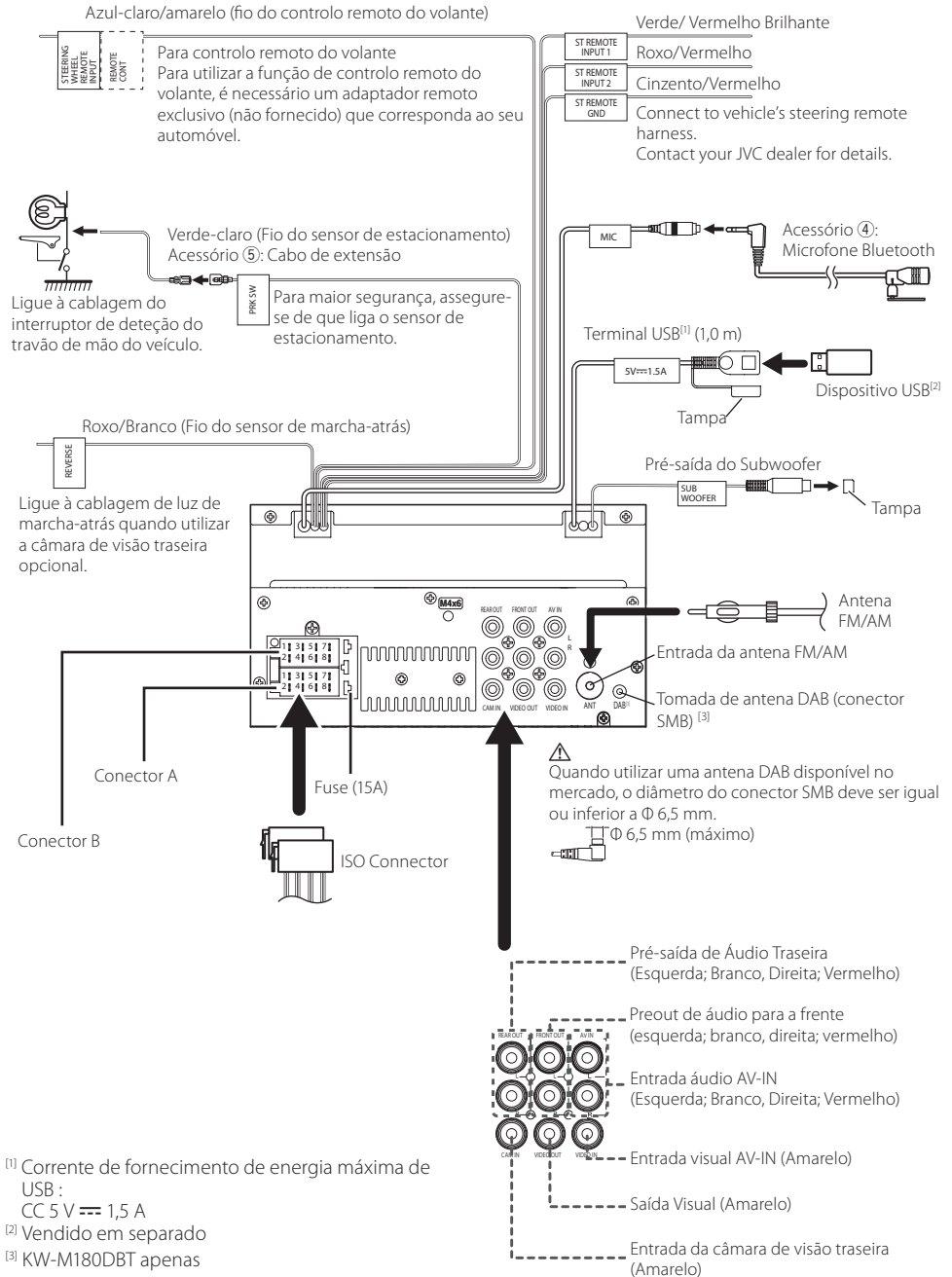

[1] Corrente de fornecimento de energia máxima de USB :  
CC 5 V  $\overline{\text{V}}$  1,5 A

[2] Vendido em separado

[3] KW-M180DBT apenas

# Instalação

## ■ Guia de funcionamento do conector da cablagem elétrica

Pino	Cor e função	
A-4	Amarelo	Bateria
A-5	Azul/Branco <sup>[1]</sup>	Controlo de energia
A-7	Vermelho	Ignição (ACC)
A-8	Preto	Ligação terra (massa)
B-1/ B-2	Roxo (+) / Roxo/Preto (-)	Traseiro direito
B-3/ B-4	Cinzento (+) / Cinzento/Preto (-)	Dianteiro direito
B-5/ B-6	Branco (+) / Branco/Preto (-)	Dianteiro esquerdo
B-7/ B-8	Verde (+) / Verde/Preto (-)	Traseiro esquerdo

<sup>[1]</sup> Máx. 150 mA, 12 V

- Impedância do Altifalante: 4-8 Ω

### ⚠ ATENÇÃO

Antes de conectar os ISO comercialmente disponibilizados à unidade, verifique a seguinte condição:

- Certifique-se de que a atribuição de pino do conector corresponde à unidade JVC.
- Tenha precaução redobrada com o cabo de alimentação.
- Caso o cabo da pilha e o cabo de ignição não correspondam, altere-os adequadamente.
- Caso o carro não tenha um cabo de ignição, use uma interface disponível comercialmente.

## ■ Conectar um iPhone/Android

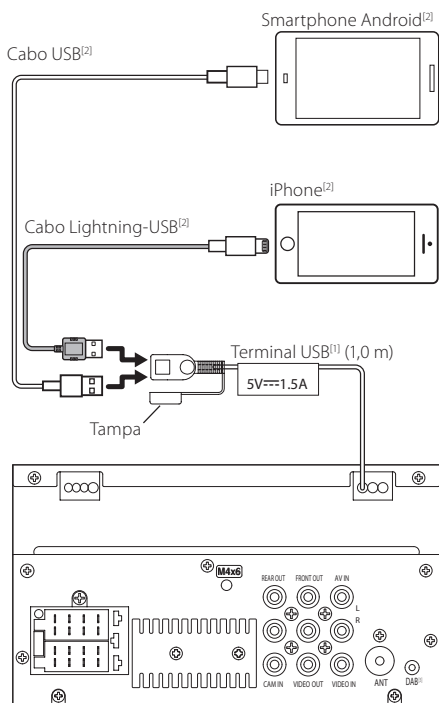

<sup>[1]</sup> Corrente de fornecimento de energia máxima de USB :

CC 5 V --- 1,5 A

<sup>[2]</sup> Vendido em separado

<sup>[3]</sup> KW-M180DBT apenas

# Sobre esta unidade

## Mais informação

### Compatibilidade com dispositivos USB

Esta unidade consegue reproduzir ficheiros MPEG1/ MPEG2/ MPEG4/ H.264/ MKV/ MP3/ WMA/ AAC/ WAV/ FLAC/ OGG armazenados num dispositivo USB de armazenamento em massa.

- Sistema de ficheiros: FAT16 / FAT32 / NTFS / exFAT
- Esta unidade consegue reconhecer um total de 9.999 ficheiros e 320 pastas (um máximo de 9.999 ficheiros por pasta).
- O número máximo de caracteres:
  - Nomes das pastas : 70 caracteres
  - Nomes dos ficheiros : 70 caracteres
  - Etiqueta: 70 caracteres

### NOTA

- Quando o dispositivo USB está ligado a esta unidade, pode ser carregado através do cabo USB.
- Instale o dispositivo USB num local em que não prejudique uma condução segura.
- Não é possível conectar um dispositivo USB através de um hub USB e Multi Card Reader.
- Faça cópias de segurança dos ficheiros áudio utilizado nesta unidade. Os ficheiros poderão ser apagados consoante as condições de funcionamento do dispositivo USB. Da nossa parte, não haverá lugar a qualquer compensação por danos decorrentes da perda dos dados armazenados.
- Não é fornecido nenhum dispositivo USB com a unidade. Deverá adquirir um dispositivo USB disponível no mercado.
- Coloque a tampa no terminal USB quando não o estiver a utilizar.

### Ficheiros áudio reproduzíveis

Formato áudio	Taxa de bits/ (Contagem de bits)	Frequência de amostragem
MP3 (.mp3)	16 – 320kbps, VBR	16 – 48 kHz
WMA (.wma)	16 – 320kbps	16 – 48 kHz
AAC-LC (.m4a)	16 – 320kbps	16 – 48 kHz
Linear PCM (WAVE) (.wav)	(16/24 bit)	8 – 192 kHz
FLAC (.flac)	(16/24 bit)	8 – 192 kHz
Vorbis (.ogg)	(16/24 bit)	8 – 192 kHz

- Esta unidade pode mostrar a Versão 1.0/1.1/2.2/2.3/2.4 da Etiqueta ID3 (para MP3).

### NOTA

- WMA e AAC abrangido por DRM, não pode ser reproduzido.
- Mesmo que os ficheiros áudio sejam compilados com as normas indicadas anteriormente, a reprodução pode ser impossível dependendo dos tipos ou condições dos suportes ou do dispositivo.

### Ficheiros de vídeo aceitáveis

Formato de vídeo	Codec de vídeo	Codec de áudio
MPEG-1 (.mpg, .mpeg)	MPEG-1	MPEG Audio Layer 2
MPEG-2 (.mpg, .mpeg)	MPEG-2	MPEG Audio Layer 2
MPEG-4 (.mp4, .avi)	MPEG-4 (SP,ASP)	MP3, AAC-LC (2ch)
H.264/MPEG-4 AVC (.mp4, mkv, avi, .flv, .f4v)	H.264/MPG-4 AVC (BP/MP/HP)	MP3, AAC (2ch)
MKV (.mkv)	Video Format follows H.264/ MPEG-4 AVC, MPEG4, XVID	MP3, AAC, Vorbis, FLAC

## Especificações

### Secção Bluetooth

Frequência

: 2.4 – 2.48 GHz

RF Output Power (E.I.R.P.)

: +8dBm (MAX)

### Secção Áudio

Impedância de altifalante

: 4 – 8 Ω

### Geral

Tensão de operação

: bateria de automóvel de 12 V CC

### Direitos de autor

- A marca da palavra e os logótipos Bluetooth® são marcas comerciais registadas propriedade da Bluetooth SIG, Inc. e qualquer utilização de tais marcas pela JVC KENWOOD Corporation está licenciada. Outras marcas registadas e nomes de marcas são dos respetivos proprietários.
- Use of the Made for Apple badge means that an accessory has been designed to connect specifically to the Apple product(s) identified in the badge, and has been certified by the developer to meet Apple performance standards. Apple is not responsible for the operation of this device or its compliance with safety and regulatory standards. Please note that the use of this accessory with an Apple product may affect wireless performance.
- Apple, iPhone and Lightning are trademarks of Apple Inc., registered in the U.S. and other countries.
- Android is a trademark of Google LLC.
- Microsoft and Windows Media are either registered trademarks or trademarks of Microsoft Corporation in the United States and/or other countries.
- THIS PRODUCT IS LICENSED UNDER THE MPEG-4 VISUAL PATENT PORTFOLIO LICENSE FOR THE PERSONAL AND NON-COMMERCIAL USE OF A CONSUMER FOR (i) ENCODING VIDEO IN COMPLIANCE WITH THE MPEG-4 VISUAL STANDARD ("MPEG-4 VIDEO") AND/OR (ii) DECODING MPEG-4 VIDEO THAT WAS ENCODED BY A CONSUMER ENGAGED IN A PERSONAL AND NON-COMMERCIAL ACTIVITY AND/OR WAS OBTAINED FROM A VIDEO PROVIDER LICENSED BY MPEG LA TO PROVIDE MPEG-4 VIDEO. NO LICENSE IS GRANTED OR SHALL BE IMPLIED FOR ANY OTHER USE. ADDITIONAL INFORMATION INCLUDING THAT RELATING TO PROMOTIONAL, INTERNAL AND COMMERCIAL USES AND LICENSING MAY BE OBTAINED FROM MPEG LA, LLC. SEE [HTTP://WWW.MPEGLA.COM](http://WWW.MPEGLA.COM).
- THIS PRODUCT IS LICENSED UNDER THE AVC PATENT PORTFOLIO LICENSE FOR THE PERSONAL USE OF A CONSUMER OR OTHER USES IN WHICH IT DOES NOT RECEIVE REMUNERATION TO (i) ENCODE VIDEO IN COMPLIANCE WITH THE AVC STANDARD ("AVC VIDEO") AND/OR (ii) DECODE AVC VIDEO THAT WAS ENCODED BY A CONSUMER ENGAGED IN A PERSONAL ACTIVITY AND/OR WAS OBTAINED FROM A VIDEO PROVIDER LICENSED TO PROVIDE AVC VIDEO. NO LICENSE IS GRANTED OR SHALL BE IMPLIED FOR ANY OTHER USE. ADDITIONAL INFORMATION MAY BE OBTAINED FROM MPEG LA, L.L.C. SEE [HTTP://WWW.MPEGLA.COM](http://WWW.MPEGLA.COM)
- libFLAC  
Copyright (C) 2000-2009 Josh Coalson  
Copyright (C) 2011-2013 Xiph.Org Foundation
  - Redistribution and use in source and binary forms, with or without modification, are permitted provided that the following conditions are met:
  - Redistributions of source code must retain the above copyright notice, this list of conditions and the following disclaimer.

– Redistributions in binary form must reproduce the above copyright notice, this list of conditions and the following disclaimer in the documentation and/or other materials provided with the distribution.

Neither the name of the Xiph.org Foundation nor the names of its contributors may be used to endorse or promote products derived from this software without specific prior written permission.

THIS SOFTWARE IS PROVIDED BY THE COPYRIGHT HOLDERS AND CONTRIBUTORS "AS IS" AND ANY EXPRESS OR IMPLIED WARRANTIES, INCLUDING, BUT NOT LIMITED TO, THE IMPLIED WARRANTIES OF MERCHANTABILITY AND FITNESS FOR A PARTICULAR PURPOSE ARE DISCLAIMED. IN NO EVENT SHALL THE FOUNDATION OR CONTRIBUTORS BE LIABLE FOR ANY DIRECT, INDIRECT, INCIDENTAL, SPECIAL, EXEMPLARY, OR CONSEQUENTIAL DAMAGES (INCLUDING, BUT NOT LIMITED TO, PROCUREMENT OF SUBSTITUTE GOODS OR SERVICES; LOSS OF USE, DATA, OR PROFITS; OR BUSINESS INTERRUPTION) HOWEVER CAUSED AND ON ANY THEORY OF LIABILITY, WHETHER IN CONTRACT, STRICT LIABILITY, OR TORT (INCLUDING NEGLIGENCE OR OTHERWISE) ARISING IN ANY WAY OUT OF THE USE OF THIS SOFTWARE, EVEN IF ADVISED OF THE POSSIBILITY OF SUCH DAMAGE.

- libogg

Copyright (c) 2002, Xiph.org Foundation Redistribution and use in source and binary forms, with or without modification, are permitted provided that the following conditions are met:

– Redistributions of source code must retain the above copyright notice, this list of conditions and the following disclaimer.

– Redistributions in binary form must reproduce the above copyright notice, this list of conditions and the following disclaimer in the documentation and/or other materials provided with the distribution.

– Neither the name of the Xiph.org Foundation nor the names of its contributors may be used to endorse or promote products derived from this software without specific prior written permission.

THIS SOFTWARE IS PROVIDED BY THE COPYRIGHT HOLDERS AND CONTRIBUTORS "AS IS" AND ANY EXPRESS OR IMPLIED WARRANTIES, INCLUDING, BUT NOT LIMITED TO, THE IMPLIED WARRANTIES OF MERCHANTABILITY AND FITNESS FOR A PARTICULAR PURPOSE ARE DISCLAIMED. IN NO EVENT SHALL THE FOUNDATION OR CONTRIBUTORS BE LIABLE FOR ANY DIRECT, INDIRECT, INCIDENTAL, SPECIAL, EXEMPLARY, OR CONSEQUENTIAL DAMAGES (INCLUDING, BUT NOT LIMITED TO, PROCUREMENT OF SUBSTITUTE GOODS OR SERVICES; LOSS OF USE, DATA, OR PROFITS; OR BUSINESS INTERRUPTION) HOWEVER CAUSED AND ON ANY THEORY OF LIABILITY, WHETHER IN CONTRACT, STRICT LIABILITY, OR TORT (INCLUDING NEGLIGENCE OR OTHERWISE) ARISING IN ANY WAY OUT OF THE USE OF THIS SOFTWARE, EVEN IF ADVISED OF THE POSSIBILITY OF SUCH DAMAGE.

# Inhalt

Vor Verwendung .....	70
Hinweise zu diesem Handbuch .....	70
Vorsichtsmaßnahmen.....	70
<b>Erste Schritte.....</b>	<b>71</b>
Uhreinstellungen.....	71
<b>Grundlagen.....</b>	<b>72</b>
Tastenfunktionen auf dem Frontpanel.....	72
Allgemeine Funktionen.....	72
HOME-Bildschirm.....	72
Quellensteuerungsbildschirm .....	72
<b>Digitalradio .....</b>	<b>73</b>
Grundfunktionen des Digitalradios.....	73
Digitalradio-Einrichtung .....	73
<b>Tuner .....</b>	<b>74</b>
Tuner-Grundfunktionen.....	74
Voreinstellstationen .....	74
Einrichten der Radiofunktion.....	74
<b>USB .....</b>	<b>75</b>
Vorbereitung.....	75
Wiedergabefunktionen.....	75
<b>iPhone .....</b>	<b>76</b>
Vorbereitung.....	76
Wiedergabefunktionen.....	76
<b>Externe Komponenten .....</b>	<b>77</b>
Nutzung von externen Audio-/Videoplayern .....	77
Rückfahrkamera.....	77
Lernfunktion der Lenkfernbedienung.....	77
Rückwärts mit ATT.....	77
<b>Bluetooth .....</b>	<b>78</b>
Smartphone am Gerät anmelden.....	78
Telefonanrufe annehmen.....	78
Telefonanrufe tätigen.....	78
Wiedergabe mit einem Bluetooth-Audiogerät .....	79
<b>Audio-Steuerung .....</b>	<b>79</b>
Allgemeine Audio-Steuerung .....	79
<b>Installation.....</b>	<b>80</b>
Vor der Installation .....	80
Installation des Geräts.....	81
<b>Wissenswertes über dieses Gerät.....</b>	<b>85</b>
Weitere Informationen.....	85
Spezifikationen.....	85
Urheberrechte.....	86

- Detaillierte Anweisungen und Informationen finden Sie in der **BEDIENUNGSANLEITUNG** auf der folgenden Website:

<<https://www.jvc.net/cs/car/>>.



# Vor Verwendung

## Hinweise zu diesem Handbuch

- Die in dieser Anleitung gezeigten Bedienelemente sind Beispiele, die zur Verdeutlichung der Funktionen dienen sollen. Aus diesem Grund kann es zu Abweichungen von vorliegenden Panel kommen.
- Bei der Beschreibung von Bedienvorgängen verweisen eckige Klammern auf Touchkeys bzw. Tasten, die Sie bedienen sollen.
  - < >: Bezeichnung der Tasten auf dem Panel.
  - [ ]: Bezeichnung der Touchkeys



Dieses symbol für die produkte zeigt die wichtigsten anweisungen für die besonders bedeutsamen vorgänge und wartung in diesem handbuch an. Beachten sie bitte die hinweise in diesem handbuch gründlich.

## Vorsichtsmaßnahmen

### ⚠️ WARNUNG

#### ❗ Folgende Vorsichtsmaßnahmen beachten, um Brand oder Verletzungen zu vermeiden:

- Kurzschlüsse verhindern. Niemals Metallgegenstände (z. B. Münzen oder Werkzeug) ins Gerät stecken oder darin belassen.
- Verfolgen Sie die Anzeige des Geräts während der Fahrt nicht für längere Zeit.
- Falls bei der Installation Probleme auftreten, nehmen Sie Kontakt mit Ihrem JVC-Händler auf.

#### ❗ Vorsichtsmaßnahmen bei der Verwendung dieses Gerätes

- Falls Sie optionale Zusatzgeräte kaufen, kontaktieren Sie Ihren JVC-Händler, um sicherzustellen, dass sie mit dem Gerät kompatibel sind und in Ihrer Region verwendet werden können.
- Wählen sie eine sprache, in der die karteikarte karte, audio-datei usw. angezeigt wird. Siehe **Erste Schritte (S.71)**
- Das Radio Data System bzw. Radio Broadcast Data System funktioniert nur in Regionen mit Sendern, die diese Dienste unterstützen.

#### ❗ Schutz des Monitors

- Um den Monitor vor Beschädigungen zu schützen, sollten Sie ihn nicht mit einem Kugelschreiber oder einem ähnlichen spitzen Gegenstand bedienen.

#### ❗ Gerät reinigen

- Ist das Frontpanel des Geräts verschmutzt, reinigen Sie es mit einem weichen, trockenen Tuch, z. B. mit einem Silikon Tuch. Ist das Frontpanel stark verschmutzt, entfernen Sie den Schmutz mit einem angefeuchteten Tuch (mit neutralem Reinigungsmittel) und wischen Sie es anschließend wieder mit einem weichen trockenen Tuch ab.

### ⚠️ ACHTUNG

- Kein Reinigungsmittel direkt auf das Gerät sprühen. Dies könnte die mechanischen Bauteile beschädigen. Das Frontpanel nicht mit einem harten Tuch oder Lösungsmitteln wie z. B. Verdüner oder Alkohol reinigen. Dies könnte die Oberfläche zerkratzen oder Aufdrucke ablösen.

#### ❗ Gerät zurücksetzen

- Falls das Gerät bzw. das angeschlossene Gerät nicht richtig funktioniert, Gerät zurücksetzen.

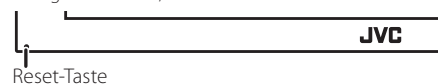

# Erste Schritte

## 1 Stellen Sie den Zündschlüssel Ihres Autos auf „ACC“.

Das Gerät ist eingeschaltet, lesen Sie bitte die Warnung und drücken Sie „Agree“, um den Bildschirm zu öffnen.



## 2 Drücken Sie die < Home >-Taste.

## 3 Drücken Sie [Settings].

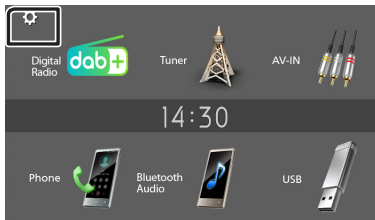

## 4 Drücken Sie den entsprechenden Touchkey und stellen Sie den Wert ein.

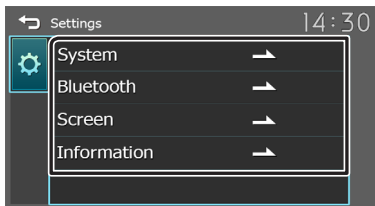

### [System]

#### [Beep Tone]

Aktiviert oder deaktiviert den Tastenberührungston. „ON“ (Werkseinstellung), „OFF“

#### [Language]

Wählen Sie die für den Steuerungsbildschirm und die Elementen zu verwendende Sprache. Die Werkseinstellung ist „English“ (Englisch).

#### [Time/Date]

Stellen Sie die Uhrzeit ein. (S.71)

#### [Clock Mode]

Wählen Sie das Anzeigeformat für die Uhrzeit aus. [12hr]/[24hr] (Werkseinstellung)

#### [Steering Remote]

Stellt die gewünschte Funktion in der Lenkfernbedienung ein. Siehe **Lernfunktion der Lenkfernbedienung (S.77)**

#### [Parking Guidelines]

Sie können den Parkassistent anzeigen, um das Einparken zu erleichtern, wenn Sie in den Rückwärtsgang (R) schalten. Werkseinstellung ist „ON“.

### [Guidelines SETUP]

Sie können die Einpark-Hilfslinien anpassen, wenn Sie [ON] für [Parking Guidelines] ausgewählt haben.

### [Reverse with ATT (-20dB)]

Wenn der Gang in die Rückwärtsstellung (R) geschaltet wird, wird die Lautstärke des Gerätes eingestellt. Standard ist „ON“. Siehe **So passen Sie die Reverse mit ATT an (S.77)**

### [System Reset]

Berühren Sie [System Reset] und berühren Sie dann [YES], um alle Einstellungen auf die anfänglichen Standardeinstellungen zurückzusetzen.

### [Bluetooth]

Zeigt den Bildschirm für die Bluetooth-Einstellungen an. (S.78)

### [Screen]

#### [Dimmer]

Wählen Sie den Helligkeitsmodus aus. „High“ (Werkseinstellung)/„Mid“/„Low“

#### [Demo]

Wählen Sie den Demonstrationsmodus aus. Werkseinstellung ist „ON“.

### [Information]

Zeigt die Softwareversion und Modellnummer dieses Geräts an

## 5 Berühren Sie [↵].

## Uhreinstellungen

### ☑ Synchronisiert die Uhrzeit mit FM RDS

Aktiviert [RDS Clock Sync].

Siehe **Einrichten der Radiofunktion (S.74)**.

### ☑ Die Uhr manuell einstellen

#### 📝 HINWEIS

- Deaktivieren Sie [RDS Clock Sync], bevor Sie die Uhrzeit einstellen.

## 1 Drücken Sie die < Home >-Taste.

## 2 Drücken Sie [Settings].

## 3 Berühren Sie [System].

## 4 Berühren Sie [Time/Date].

Der Uhrbildschirm erscheint.

## 5 Berühren Sie [▲] oder [▼], um die Uhrzeit einzustellen.

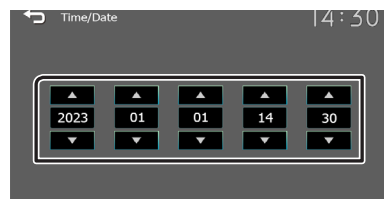

## 6 Berühren Sie [↵].

# Grundlagen

## Tastenfunktionen auf dem Frontpanel

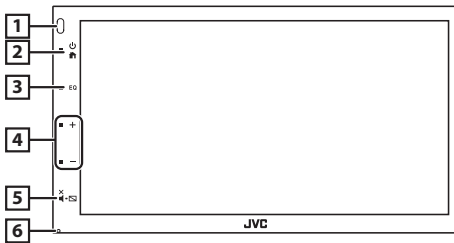

### 1 Fernbedienung

- Empfängt das Fernbedienungssignal.

### 2 (HOME)

- Zeigt den HOME-Bildschirm an. **(S.72)**
- Drücken Sie die Taste länger als 1 Sekunde, um die Stromversorgung auszuschalten.
- Ist die Stromversorgung ausgeschaltet, wird sie hierdurch eingeschaltet.

### 3 EQ

- Zeigt den Audio-Bildschirm an.\* **(S.79)**
- \* Der Audiobildschirm wird nicht angezeigt, wenn der EINRICHTUNGS-Bildschirm angezeigt wird, oder auf dem Listenbildschirm usw.

### 4 +, - (Volume)

- Lautstärkeregelung. Die Lautstärke wird bis 15 erhöht, wenn Sie [ + ] weiter drücken.

### 5 (MUTE, Display off) (Anzeige aus)

- Schaltet den Ton stumm/stellt ihn wieder her.
- Drücken Sie die Taste länger als 1 Sekunde, um den Bildschirm auszuschalten. Wenn der Bildschirm ausgeschaltet ist, berühren Sie die Anzeige, um den Bildschirm einzuschalten.

### 6 Zurücksetzen

- Wenn das Gerät oder das angeschlossene Gerät nicht richtig funktioniert, wird das Gerät auf die Werkseinstellungen zurückgesetzt, sobald diese Taste gedrückt wird.

## Allgemeine Funktionen

### Das Gerät einschalten

1 Drücken Sie die -Taste.



### Das Gerät ausschalten

1 Halten Sie die Taste gedrückt.

## HOME-Bildschirm

1 Drücken Sie die -Taste



Der HOME-Bildschirm erscheint.

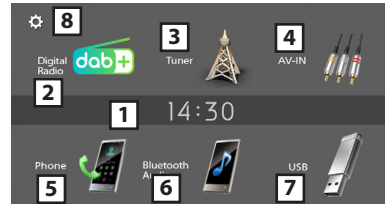

1 Uhranzeige

2 Schaltet auf DAB-Radio um. \* **(S.73)**  
\* nur KW-M180DBT

3 Switches to the radio broadcast. **(S.74)**

4 Wechselt zu einer externen Komponente, die an den AV-IN-Eingangsanschluss angeschlossen ist. **(S.77)**

5 Zeigt den Freisprechbildschirm an. **(S.78)**

6 Spielt einen Bluetooth-Audioplayer ab. **(S.79)**

7 [USB]

Gibt die Dateien auf einem USB-Gerät wieder. **(S.75)**

[iPhone]

Spielt einen iPhone ab. **(S.76)**

- Wenn ein iPhone angeschlossen ist.

[Mirroring]

Zeigt den Spiegelungsbildschirm an.

- Wenn ein Android-Gerät mit der installierten Anwendung „Mirroring OB for JVC“ verbunden ist.

8 Zeigt den SETUP-Bildschirm an. **(S.71)**

## Quellensteuerungsbildschirm



1 : Kehrt zum vorherigen Bildschirm zurück.

: Zeigt den Audiobildschirm an. **(S.79)**



# Digitalradio (KW-M180DBT)

## Grundfunktionen des Digitalradios

- 1 Drücken Sie die <🏠>-Taste
- 2 Drücken Sie [Digital Radio].

### ■ Quellensteuerungsbildschirm

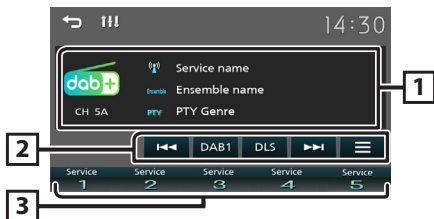

- 1 Zeigt die Informationen zum aktuellen Service an: Servicename, Ensemblename, PTY-Genre, Kanal
- 2 **[DAB]**: Schaltet das voreingestellte DAB-Band um.  
„DAB1“, „DAB2“, „DAB3“  
**[DLS]**: Zeigt den Bildschirm für die Textinformationen an.  
**[◀▶]**: Wählen Sie ein Ensemble, einen Service und eine Komponente aus.  
**[☰]**: Zeigt den Digitalradio-Einrichtungsbildschirm an. **(S.73)**
- 3 Ruft die gespeicherten Services auf.  
Wenn Sie die Taste 2 Sekunden lang gedrückt halten, wird der gerade empfangene Service gespeichert.

### ■ Speichern eines Service

Sie können den aktuell empfangenen Service speichern.

- 1 Wählen Sie einen Service aus, den Sie voreinstellen möchten.
- 2 Berühren und halten Sie [#] fest (#:1-5), wo Sie den Service speichern möchten.

### ■ Auswahl eines gespeicherten Service

- 1 Berühren Sie [#] (#: 1-5).

## Digitalradio-Einrichtung

- 1 Drücken Sie [☰].
- 2 Jedes Element wie folgt einstellen.

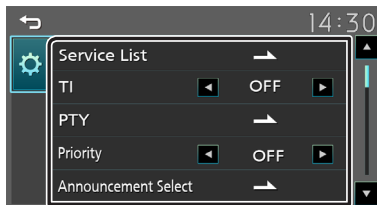

### [Service List]

Zeigt den Servicelisten-Bildschirm an.

- [☰]: Berühren und dann [Yes] berühren, um die aktuellste Serviceliste zu finden.

### [TI]

Wechselt automatisch zu den Verkehrsnachrichten, sobald die Verkehrsmeldung startet.

„ON“, „OFF“ (Werkseinstellung)

### [PTY]

Sucht ein Programm nach der Programmsparte.

### [Priority]

Falls der gleiche Dienst auch über das RadioDatenSystem angeboten wird, wenn der Empfang eines über Digital-Radio angebotenen Dienstes schlecht geworden ist, wird automatisch auf das RadioDatenSystem umgeschaltet.  
„ON“, „OFF“ (Werkseinstellung)

### [Announcement Select]

Schaltet auf den eingestellten Ansagedienst um.

### [Related Service]

Wenn Sie EIN auswählen, schaltet das Gerät zu einem verwandten Service (wenn vorhanden), wenn kein DAB-Servicenetzwerk vorhanden ist.  
Werkseinstellung ist „OFF“.

### [Antenna Power]

Schaltet die Stromversorgung für die Digital-Radio-Antenne. Auf „ON“ einstellen, wenn die verwendete Digital-Radio-Antenne mit einem Antennenverstärker ausgestattet ist.  
Werkseinstellung ist „ON“.

- 3 Berühren Sie [↩].

# Tuner

## Tuner-Grundfunktionen

- 1 Drücken Sie die <🏠>-Taste.
- 2 Berühren Sie [Tuner].

### ☑ Quellensteuerungsbildschirm

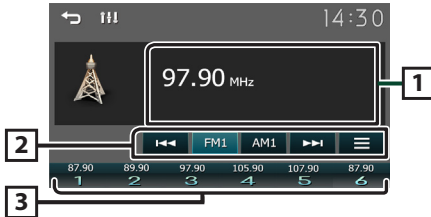

- 1 Zeigt die Information zum aktuellen Sender an: PS-Name, Frequenz, PTY-Genre, Anzeigeelemente
- 2 **[FM]**: Schaltet das UKW-Frequenzband um. „FM1“, „FM2“, „FM3“  
**[AM]**: Schaltet das MW-Frequenzband um. „AM1“, „AM2“  
**[◀▶]**: Stellt automatisch einen Sender mit gutem Empfang ein.  
**[☰]**: Zeigt den Radioeinstellungsbildschirm an. (S.74)
- 3 Ruft den gespeicherten Sender auf. Wenn Sie die Taste 2 Sekunden lang gedrückt halten, wird der gerade empfangene Sender gespeichert.

## Voreinstellstationen

### ☑ Automatische Programmspeicherung

Sie können für das aktuelle Band (UKW1/UKW2/UKW3/MW1/MW2) 6 Sender voreinstellen.

- 1 Berühren Sie **[FM]** oder **[AM]**, um das Frequenzband auszuwählen.
  - 2 Drücken Sie **[☰]**.
  - 3 Berühren Sie **[Auto Store]**.  
Die örtlichen Sender mit den stärksten Signalen werden gesucht und automatisch gespeichert.
- ### ☑ Manuelle Speicherung
- Sie können den aktuell empfangenen Sender speichern.
- 1 Wählen Sie einen Sender, den Sie voreinstellen möchten.
  - 2 Berühren und halten Sie **[#]** fest (#:1-6), wo Sie den Sender speichern möchten.
- ### ☑ Abrufen des gespeicherten Senders.
- 1 Berühren Sie **[#]** (:#:1-6).

## Einrichten der Radiofunktion

- 1 Drücken Sie **[☰]**.
- 2 Jedes Element wie folgt einstellen.

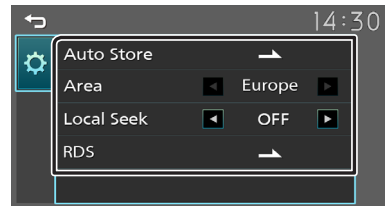

### **[Auto Store]**

Sucht und speichert die 6 Sender mit den stärksten Signalen automatisch für das ausgewählte Band. „Auto Store“ erscheint.

### **[Area]**

„Europe“: AM/FM-Intervalle: 9 kHz/50 kHz.

### **[Local Seek]**

Stellt nur Sender mit ausreichender Signalstärke ein. **(LOC)**-Anzeige leuchtet auf.  
„ON“, „OFF“ (Werkseinstellung)

### **[RDS] \*1**

Zeigt den RDS-Einstellungsbildschirm an.

### **[AF]**

Bei schlechtem Empfang eines bestimmten Radiosenders wird automatisch zu einem Sender umgeschaltet, der dasselbe Programm über dasselbe Radio-Data-System-Netzwerk sendet.  
„ON“, „OFF“ (Werkseinstellung), „OFF“

### **[TA]**

Wechselt automatisch zu den Verkehrsnachrichten, sobald die Verkehrsmeldung startet. (Die **TI**-Anzeige leuchtet auf.)  
„ON“, „OFF“ (Werkseinstellung)

### **[RDS Clock Sync]**

Synchronisiert die Radiodaten-System-Sender-Zeitdaten und diese Geräteuhr.  
„ON“, „OFF“ (Werkseinstellung), „OFF“

### **[PTY]**

Wählen Sie eine Programmsparte aus.

### **[PTY Seek]**

Sucht ein Programm nach der Programmsparte.

\*1 nur UKW

- 3 Berühren Sie **[↩]**.

# USB

## Vorbereitung

### ■ Anschluss eines USB-Geräts

- 1 Nehmen Sie den Deckel des USB-Anschlusses ab.
- 2 USB-Gerät und USB-Kabel verbinden.

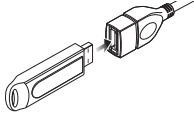

Das Gerät liest das Gerät und die Wiedergabe wird gestartet.

### ■ Zum Trennen der USB-Geräteverbindung:

- 1 Drücken Sie die <🏠>-Taste.
- 2 Berühren Sie eine andere Quelle als [USB].
- 3 Trennen Sie das USB-Gerät ab.

### ■ Verwendbare USB-Geräte

Dieses Gerät kann MPEG1/MPEG2/MPEG4/H.264/MKV/MP3/WMA/AAC/WAV/FLAC/OGG-Dateien wiedergeben, die auf einem USB-Massenspeicher gespeichert sind. (S.85)

## Wiedergabefunktionen

### ■ Steuern Sie die Wiedergabe der Musik am Quellensteuerungsbildschirm.

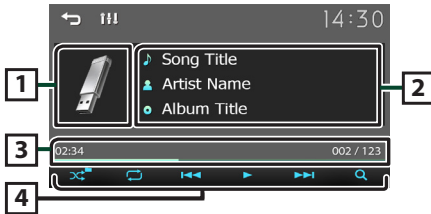

- 1 Die Hülle der aktuell abgespielten Datei wird angezeigt.
- 2 Zeigt die Information zur aktuellen Datei an.
- 3 Wiedergabezeit/Dateinummer  
Wiedergabezeitleiste: Zur Bestätigung der aktuellen Wiedergabeposition
- 4 [⏮]: Wählt den Zufallswiedergabemodus aus.  
[🔄]: Wählt den Wiederholungswiedergabemodus aus.  
[⏸], [⏹]: Wiedergabe oder Pause.  
[⏪], [⏩]: Sucht den vorigen/nächsten Inhalt.  
Für schnellen Vorlauf oder schnellen Rücklauf anhaltend drücken.  
[🔍]: Sucht die Datei. (S.75)

### ■ Für die Videowiedergabe

- 1 Wenn die Bedientasten nicht auf dem Bildschirm angezeigt werden, berühren Sie das Display.

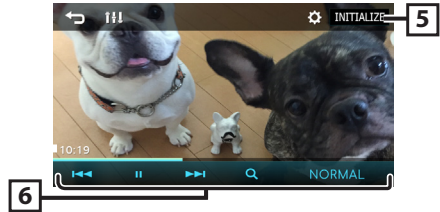

- 5 [⚙️]: Sie können die Bildqualität auf dem Videobildschirm anpassen.  
[INITIALIZE]: Um die Anpassung zu löschen.
- 6 [▶], [⏸]: Wiedergabe oder Pause.  
[⏪], [⏩]: Sucht den vorigen/nächsten Inhalt.  
Für schnellen Vorlauf oder schnellen Rücklauf anhaltend drücken.  
[🔍]: Sucht die Datei. (S.75)  
[NORMAL]/[16:9]/[4:3]: Wählen Sie einen Bildschirmmodus aus.

### ■ Auswählen eines Titels in einer Liste (nach Datei suchen)

- 1 Berühren Sie [🔍].
- 2 Wählen Sie aus, ob Sie nach Audiodateien [🎵] oder Videodateien [📺] suchen möchten.

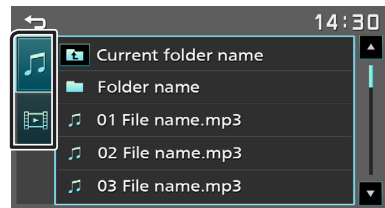

- 3 Berühren Sie [📁], um in die obere Hierarchie zu gelangen.
  - 4 Drücken Sie auf den gewünschten Ordner.  
Berühren Sie einen Ordner, um den Ordnerinhalt anzuzeigen.  
• Berühren Sie [↩], um in die obere Hierarchie zu gelangen.
  - 5 Gewünschtes Element der Liste drücken.  
Startet Wiedergabe.
- 📌 HINWEIS
- Wenn Sie [↩] in der obersten Hierarchie berühren, erscheint der Quellensteuerungsbildschirm.

## Vorbereitung

### ■ Anschluss des iPhones

- Für Details zum Anschluss eines iPhone, siehe Seite 84.

### 1 Nehmen Sie den Deckel des USB-Anschlusses ab.

### 2 Schließen Sie das iPhone an.

Das Gerät liest das Gerät und die Wiedergabe wird gestartet.

### ■ Zum Trennen des iPhone

#### 1 Drücken Sie die <🏠>-Taste.

#### 2 Berühren Sie eine andere Quelle als [iPhone].

#### 3 Trennen Sie den iPhone ab

### ■ Anschließbare iPhones

Die nachfolgend aufgeführten Modelle können an dieses Gerät angeschlossen werden.

Konzipiert für

- iPhone 14 Pro Max
- iPhone 14 Pro
- iPhone 14 Plus
- iPhone 14
- iPhone 13 Pro Max
- iPhone 13 Pro
- iPhone 13
- iPhone 13 mini
- iPhone 12 Pro Max
- iPhone 12 Pro
- iPhone 12
- iPhone 12 mini
- iPhone SE (2nd generation)
- iPhone 11 Pro Max
- iPhone 11 Pro
- iPhone 11
- iPhone XS Max
- iPhone XS
- iPhone XR
- iPhone X
- iPhone 8 Plus
- iPhone 8
- iPhone 7 Plus
- iPhone 7
- iPhone SE
- iPhone 6s Plus
- iPhone 6s

### 📎 HINWEIS

- Starten Sie die Wiedergabe nach Anschluss des iPhones, wird zuerst die Musik wiedergegeben, die vom iPhone abgespielt wurde.
- Setzen Sie den Deckel auf den USB-Anschluss auf, wenn er nicht verwendet wird.

## Wiedergabefunktionen

### ■ Steuern Sie die Wiedergabe der Musik am Quellensteuerungsbildschirm.



1 Illustration (wird angezeigt, wenn der Titel eine Illustration enthält)

2 Zeigt die Information zur aktuellen Datei an.

3 Wiedergabezeit/Dateinummer  
Wiedergabezeitleiste : Zur Bestätigung der aktuellen Wiedergabeposition

4 [⏮]: Wählt den Zufallswiedergabemodus aus.

[🔄]: Wählt den Wiederholungswiedergabemodus aus.

[▶], [⏸]: Wiedergabe oder Pause.

[⏪], [⏩]: Sucht den vorigen/nächsten Inhalt.  
Für schnellen Vorlauf oder schnellen Rücklauf anhaltend drücken.

[🔍]: Sucht den Inhalt. (S.76)

### ■ Einen Inhalt in einer Liste auswählen

#### 1 Berühren Sie [🔍].

#### 2 Drücken Sie auf die gewünschte Option.

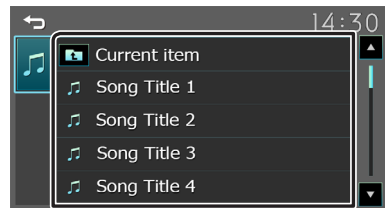

Wenn Sie eine Kategorie berühren, werden ihre Inhalte angezeigt.

#### 3 Gewünschtes Element der Liste drücken.

Startet Wiedergabe.

- Berühren Sie [↩], um in die obere Hierarchie zu gelangen.

### 📎 HINWEIS

- Wenn Sie [↩] in der obersten Hierarchie berühren, erscheint der Quellensteuerungsbildschirm.

# Externe Komponenten

## Nutzung von externen Audio-/ Videoplayern

### Wiedergabe starten

- 1 Schließen Sie eine externe Komponente an den AV-IN-Eingangsanschluss an. (S.83)
- 2 Drücken Sie die <🏠>-Taste.
- 3 Berühren Sie [AV-IN].
- 4 Schalten Sie die angeschlossene Komponente ein und starten Sie die Wiedergabe der Quelle.

### Für die Videowiedergabe

- 1 Wenn die Bedientasten nicht auf dem Bildschirm angezeigt werden, berühren Sie das Display.

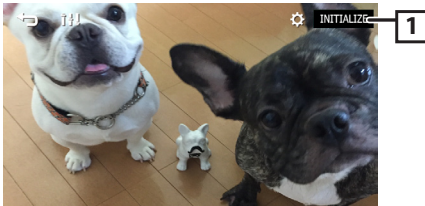

- 1 : Sie können die Bildqualität auf dem Videobildschirm anpassen.  
**[INITIALIZE]** : Um die Anpassung zu löschen.

### HINWEIS

- Wenn das Bild der Rückfahrkamera auf dem AV-IN-Bildschirm angezeigt wird, verschwindet die Bildausgabe vom Video-Ausgangsanschluss.

## Rückfahrkamera

Um eine Rückfahrkamera nutzen zu können, ist die RÜCKWÄRTS-Kabelverbindung erforderlich. Zum Anschluss einer Rückfahrkamera. (S.83)

### Anzeige des Bildes von der Rückfahrkamera

Der Rückansichtsbildschirm wird angezeigt, wenn Sie in den Rückwärtsgang (R) schalten.



- Die erste Berührung entfernt die Vorsicht, und die zweite Berührung schließt den Kamerabildschirm.

## Lernfunktion der Lenkfernbedienung

Diese Funktion ist nur verfügbar, wenn Ihr Fahrzeug mit der elektrischen Lenkfernbedienung ausgestattet ist.

- 1 Drücken Sie die <🏠>-Taste.
- 2 Drücken Sie [Settings].
- 3 Drücken Sie [System].
- 4 Drücken Sie [Steering Remote].
- 5 Berühren Sie die Funktion, die Sie einstellen möchten.
- 6 Halten Sie die Taste der Fernbedienung gedrückt.

### HINWEIS

- Sie können das Gerät alle Tasten auf einmal erlernen lassen. Drücken Sie in diesem Fall nacheinander alle Tasten, und nachdem Sie alle gedrückt haben, berühren Sie [↵] im Einstellungsbildschirm der Lenkfernbedienung.

- 7 Wiederholen Sie die Schritte 5 und 6 nach Bedarf.

- 8 Berühren Sie [↵].

### HINWEIS

- Berühren Sie [Initialize] und berühren Sie danach [Yes], um alle Markierungen auf ihre anfänglichen Standardpositionen zu setzen.

## Rückwärts mit ATT (-20dB)

When the gear is shifted to the reverse (R) position, the volume of the device is adjusted.

- 1 Drücken Sie die <🏠>-Taste.
- 2 Drücken Sie [Settings].
- 3 Drücken Sie [System].
- 4 Drücken Sie [Reverse with ATT].
- 5 Drücken Sie [◀] oder [▶] gesetzt auf [ON]/[OFF].

### HINWEIS

- Der Einstellwert ist ON (Standard)

# Bluetooth

## Smartphone am Gerät anmelden

Sie können Ihr Bluetooth-Smartphone verwenden, wenn es mit diesem Gerät verbunden ist.

- 1 Schalten Sie die Bluetooth-Funktion an Ihrem Smartphone/Mobiltelefon ein.
- 2 Suchen Sie das Gerät ("KW-M180DBT"/"KW-M180BT") auf Ihrem Smartphone/Mobiltelefon.  
Wenn die Eingabe eines PIN-Codes erforderlich ist, geben Sie den PIN-Code („0000“) ein.
  - erscheint, wenn das Bluetooth-Smartphone angeschlossen ist.

### Trennen des Geräts

- Schalten Sie die Bluetooth-Funktion auf Ihrem Smartphone/Mobiltelefon aus.
- Schalten Sie das Zündschloss aus.

## Telefonanrufe annehmen

### 1 Drücken Sie [].

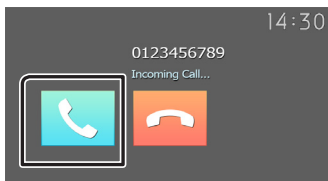

- []: Lehnen Sie einen eingehenden Anruf ab.

### Bedienvorgänge während eines Anrufs

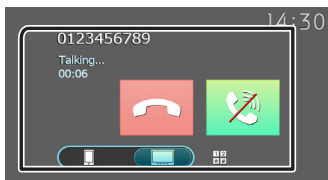

- [] Auflegen
- [] Stumm deine Stimme
- [] Durch Berührung der entsprechenden Touchkeys auf dem Bildschirm können Sie Wahlöne festlegen.
  - Berühren Sie [], um das Fenster zu schließen.
- [] Wechselt die ausgegebene Gesprächsstimme zwischen Smartphone/Mobiltelefon und Lautsprecher um.

### Hörerlautstärke einstellen

Drücken Sie <->- oder die <->-Taste.

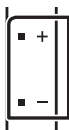

## Telefonanrufe tätigen

- 1 Drücken Sie die <img alt="Hintergrundbeleuchtung-Taste"/>-Taste.
- 2 Berühren Sie [Phone].
- 3 Siehe nachfolgende Tabelle für jeweilige Betriebsmethode.

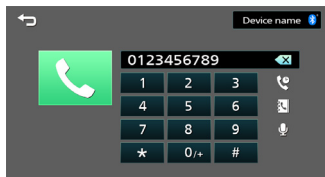

### Anruf durch Eingabe einer Telefonnummer

- 1) Geben Sie eine Telefonnummer mittels Zifferntasten ein.
- 2) Berühren Sie [].  
Einen Anruf durchführen

  - Berühren Sie [], um den letzten Eintrag zu löschen.

### Anruf tätigen mittels Anruflisten

- 1) Berühren Sie [].
- 2) Berühren Sie [] (Eingehende Anrufe), [] (Abgehende Anrufe), [] (Verpasste Anrufe).
- 3) Wählen Sie die Telefonnummer von der Liste.  
Einen Anruf durchführen

### Anruf tätigen mittels Telefonbuch

- 1) Drücken Sie [].
- 2) Wählen Sie den Namen von der Liste.  
Einen Anruf durchführen

  - []: Aktualisiert das Telefonbuch. Berühren Sie diese Schaltfläche, nachdem Sie eine Änderung im Telefonbuch Ihres Smartphones/Mobiltelefons vorgenommen haben.

### Anruf Warten

Wenn Sie einen neuen Anruf erhalten, während Sie am Telefon sprechen:

- 1) Berühren Sie [], der aktuelle Anruf wird in die Warteschleife gestellt und Sie können den neu empfangenen Anruf annehmen.
- 2) Jedes Mal, wenn Sie [], berühren, wechselt der Anrufer zum anderen.
- 3) Wenn Sie [] während des Anrufwartens berühren, lehnen Sie einen eingehenden Anruf ab.
- 4) Wenn Sie [], berühren, wenn jemand in der Warteschleife ist, wird der aktuelle Anruf zu dem Anruf geschwungen, der auf Warteschleife wartet.
- 5) Berühren Sie [] stummschalten Sie Ihre Stimme.

## Bluetooth

### Wiedergabe mit einem Bluetooth-Audiogerät

- 1 Drücken Sie die <🏠>-Taste.
- 2 Berühren Sie [Bluetooth Audio].

#### ■ Quellensteuerungsbildschirm

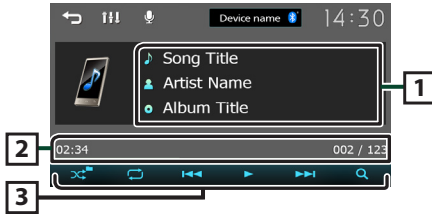

- 1 Zeigt die Information zur aktuellen Datei an.
- 2 Wiedergabezeit/Dateinummer  
Wiedergabezeileiste : Zur Bestätigung der aktuellen Wiedergabeposition
- 3 [🎲] : Wählt den Zufallwiedergabemodus aus.  
[🔁] : Wählt den Wiederholungswiedergabemodus aus.  
[▶], [⏸] : Wiedergabe oder Pause.  
[⏮], [⏭] : Sucht den vorigen/nächsten Inhalt.  
Für schnellen Vorlauf oder schnellen Rücklauf anhaltend drücken.  
[🔍] : Sucht die Datei. (S.79)

#### 📎 HINWEIS

- Die Funktionen und Anzeigen können je nach ihrer Verfügbarkeit auf dem angeschlossenen Gerät abweichen.

#### ■ Einen Inhalt in einer Liste auswählen

- 1 Berühren Sie [🔍].
- 2 Drücken Sie auf die gewünschte Option.  
Wenn Sie eine Kategorie berühren, werden ihre Inhalte angezeigt.
- 3 Gewünschtes Element der Liste drücken.  
Startet Wiedergabe.
  - Berühren Sie [↶], um in die obere Hierarchie zu gelangen.

#### 📎 HINWEIS

- Wenn Sie [↶] in der obersten Hierarchie berühren, erscheint der Quellensteuerungsbildschirm.

## Audio-Steuerung

Sie können unterschiedliche Einstellungen wie die Audiobalance oder den Subwooferpegel einstellen.

- 1 Drücken Sie die <EQ>-Taste.
- 2 Nachfolgend finden Sie die jeweilige Betriebsmethode.

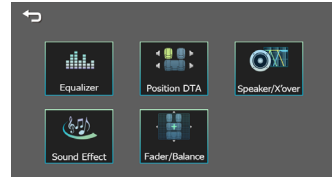

### Allgemeine Audio-Steuerung

- 1 Drücken Sie die <EQ>-Taste.
- 2 Berühren Sie [Fader / Balance].
- 3 Jedes Element wie folgt einstellen.

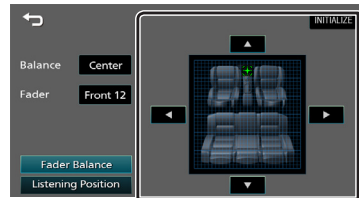

#### [Fader Balance]

**Balance** Stellen Sie die linke und rechte Lautstärke-Balance ein.

[◀] [▶]  
15 (links) to 15 (rechts)

**Fader** Stellt die vordere und hintere Lautstärke-Balance ein.

[▲] [▼]  
15 (vorn) bis 15 (hinten)

[INITIALIZE] Um die Anpassung zu löschen.

#### [Listening Position]

[●] Wählen Sie eine Hörposition aus „Front Left“, „Front All“, „Front Right“, und „Middle“ aus.

[INITIALIZE] Um die Anpassung zu löschen.

# Installation

## Vor der Installation

Vor der Installation dieses Geräts beachten Sie bitte die folgenden Vorsichtsmaßnahmen.

### ▲WARNHINWEISE

- Verbinden Sie Zünddraht (rot) und Batteriekabel (gelb) mit dem Fahrzeugchassis (Erde), so könnte dies zu einem Kurzschluss führen, der ein Feuer entzündet. Schließen Sie diese Drähte nur an eine Stromquelle an, die durch den Sicherungskasten geführt wird.
- Zündkabel (rot) und Batteriekabel (gelb) dürfen ohne Einbindung einer Sicherung installiert werden. Zwischen Stromversorgung und Kabel muss immer eine Sicherung installiert sein.

### ▲ACHTUNG

- Montieren Sie dieses Gerät in der Konsole Ihres Fahrzeugs.  
Berühren Sie die Metallteile des Geräts während oder kurz nach der Benutzung nicht. Metallteile wie der Kühlkörper und das Gehäuse werden heiß.

### HINWEIS

- Die Montage sowie die Verkabelung dieses Gerätes macht besondere Fähigkeiten und Erfahrung erforderlich. Überlassen Sie die Montage- und Verkabelungsarbeiten aus Sicherheitsgründen ausgewiesenen Fachpersonal.
- Betreiben Sie das Gerät ausschließlich mit 12-Volt-Gleichstrom und negativer Masseverbindung.
- Setzen Sie weder die Frontblende noch deren Etui direktem Sonnenlicht, extremer Wärme oder Luftfeuchtigkeit aus. Schützen Sie diese Teile außerdem vor Staub und Spritzwasser.
- Verwenden Sie für den Einbau ausschließlich die mitgelieferten Schrauben. Verwenden Sie ausschließlich die mitgelieferten Schrauben. Falsche Schrauben können das Gerät beschädigen.
- Wenn die Zündung Ihres Fahrzeuges keine ACC-Stellung hat, dann schließen Sie die Zündkabel an eine Stromquelle an, die mit dem Zündschlüssel ein- und ausgeschaltet werden kann. Wenn Sie das Zündkabel an eine Stromquelle mit konstanter Stromversorgung anschließen, wie z. B. Batteriekabel, kann dies die Batterie entleeren.
- Hat die Konsole eine Klappe, dann stellen Sie bei der Installation des Gerätes sicher, dass das Frontpanel beim Öffnen und Schließen nicht gegen die Klappe stößt.
- Wenn die Sicherung durchbrennt, überprüfen Sie zuerst, dass die Drähte sich nicht berühren und einen Kurzschluss verursachen. Ersetzen Sie dann die durchgebrannte Sicherung durch eine neue Sicherung mit den gleichen Nenngrößen.

- Isolieren Sie nicht angeschlossene Kabel mit Vinylband oder ähnlichem Material. Entfernen Sie nicht die Kappen von den Enden nicht angeschlossener Kabel und Anschlüsse, damit keine Kurzschlüsse entstehen.
- Sichern Sie die Leitungen mit Kabelklemmen und umwickeln Sie die Drähte mit Vinylband, die in Kontakt mit Metallteilen kommen, um die Kabel zu schützen und Kurzschlüsse zu verhindern.
- Schließen Sie beide Pole der Lautsprecher an den Lautsprecherausgängen am Gerät an. Das Gerät kann beschädigt werden oder den Dienst versagen, wenn Sie die ⊖-Leiter zusammenführen oder über Metallteile des Fahrzeugs erden.
- Sind nur zwei Lautsprecher an das System angeschlossen, nutzen Sie die Anschlüsse entweder an den beiden vorderen oder an den beiden hinteren Ausgangsklemmen (nicht 1x vorne und 1x hinten anschließen). Wenn Sie zum Beispiel den ⊕-Stecker des linken Lautsprechers an eine Ausgangsbuchse für vorne anschließen, darf der ⊖-Stecker nicht an eine Ausgangsbuchse für hinten angeschlossen werden.
- Überprüfen Sie nach der Montage des Geräts, ob die Bremslichter, Blinker, Scheibenwischer usw. ordnungsgemäß funktionieren.
- Das Gerät so anbringen, dass der Montagewinkel 30 ° oder weniger beträgt.
- Bei der Installation des Gerätes im Fahrzeug dürfen Sie nicht zu sehr auf die Paneloberfläche drücken. Ansonsten könnte es zu Kratzern, Beschädigungen oder Fehlfunktionen kommen.
- Die Empfangsqualität wird u. U. durch metallische Gegenstände in der Nähe der Bluetooth-Antenne beeinträchtigt.

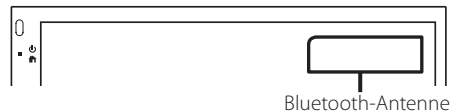



## Installation

### ■ Für die Installation mitgeliefertes Zubehör

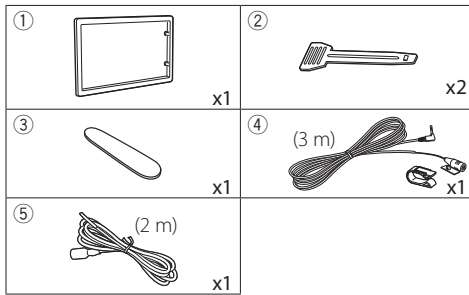

### ■ Installationsvorgang

- 1) Um einem Kurzschluss vorzubeugen, ziehen Sie bitte den Schlüssel aus dem Zündschloss und trennen Sie die  $\ominus$ -Klemme der Batterie ab.
- 2) Schließen Sie die Eingangs- und Ausgangskabel jedes Gerätes richtig an.
- 3) Schließen Sie alle Kabel am Kabelbaum an.
- 4) Schließen Sie den Steckverbinder B des Kabelbaums am Lautsprecheranschluss Ihres Fahrzeugs an.
- 5) Schließen Sie den Steckverbinder A des Kabelbaums am externen Stromanschluss Ihres Fahrzeugs an.
- 6) Schließen Sie den Kabelbaumanschluss am Gerät an.
- 7) Bauen Sie das Autoradio in Ihrem Fahrzeug ein.
- 8) Schließen Sie die  $\ominus$ -Klemme der Batterie wieder an.
- 9) Drücken Sie die Reset-Taste.

### Installation des Geräts

#### ■ Nichtjapanische Autos

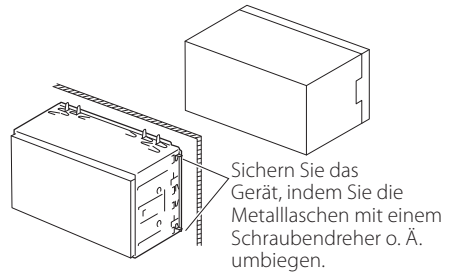

#### HINWEIS

- Stellen Sie sicher, dass das Gerät fest sitzt. Falls das Gerät nicht fest sitzt, können Fehlfunktionen (beispielsweise Sprünge bei der Wiedergabe) auftreten.

#### ■ Ziertafel

- 1) Bringen Sie das Zubehör ① am Gerät an.

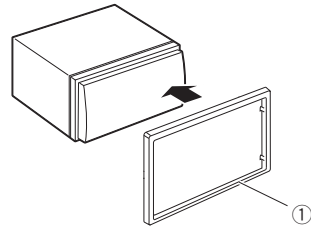

# Installation

## ■ Mikrofoneinheit

- 1) Überprüfen Sie die Einbauposition des Mikrofons (Zubehör ④).
- 2) Säubern Sie die Installationsfläche.
- 3) Entfernen Sie die Schutzfolie vom Mikrofon (Zubehör ④) und kleben Sie das Mikrofon an die unten gezeigte Stelle.
- 4) Verlegen Sie das Mikrokabel bis zum Gerät und befestigen Sie es an mehreren Punkten mit Klebeband oder Ähnlichem.
- 5) Richten Sie die Richtung des Mikrofons (Zubehör ④) auf den Fahrer aus.

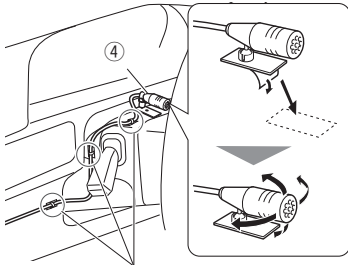

Befestigen Sie das Kabel mit handelsüblichem Klebeband.

## HINWEIS

- Tauschen Sie bei Bedarf die Clips aus.

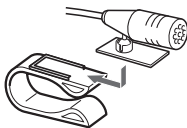

## ■ Entfernen der Zierrafel

- 1) Nutzen Sie den Entnahmeschlüssel (Zubehör ③), um die vier Laschen auszuhebeln (zwei am linken Teil, zwei am rechten Teil).

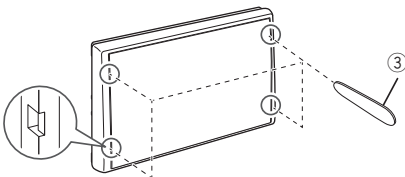

- 2) Ziehen Sie die Zierrafel nach vorn.

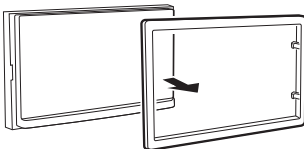

## ■ Ausbauen des Geräts

- 1) Entfernen Sie wie unter Schritt 1 von „Entfernen der Zierrafel“ beschrieben die Zierrafel.
- 2) Führen Sie den Entnahmeschlüssel (Zubehör ②) tief in den Schlitz ein, wie abgebildet. (Der vorstehende Teil an der Spitze des Entnahmeschlüssels muss zum Gerät zeigen.)

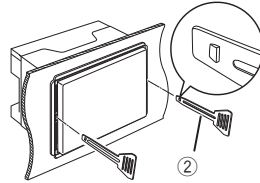

- 3) Wenn der Entnahmeschlüssel eingerastet ist, führen Sie den anderen Entnahmeschlüssel in den Schlitz ein.

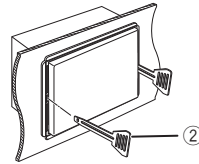

- 4) Ziehen Sie das Gerät halb heraus.



## HINWEIS

- Gehen Sie vorsichtig vor, um sich nicht an den Vorsprüngen des Entnahmewerkzeugs zu verletzen.
- 5) Umfassen Sie das Gerät mit beiden Händen und ziehen Sie es vorsichtig heraus, damit es nicht herunterfällt.

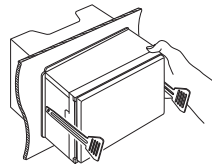

# Installation

## ■ Anschließen der Kabel an die Anschlüsse

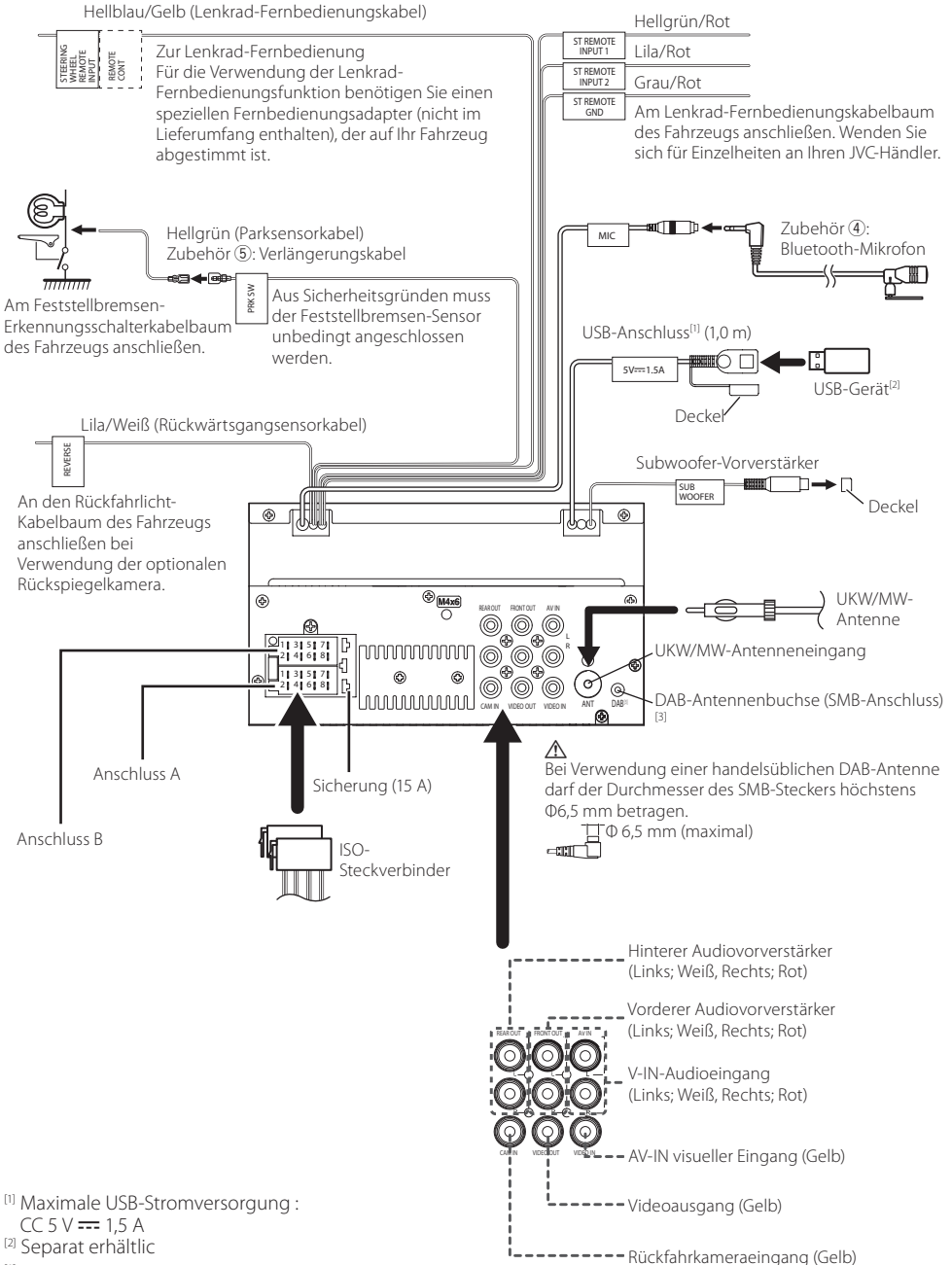

<sup>(1)</sup> Maximale USB-Stromversorgung :

CC 5 V = 1,5 A

<sup>(2)</sup> Separat erhältlich

<sup>(3)</sup> nur KW-M180DBT

# Installation

## ■ Funktionsanleitung für den Kabelbaumanschluss

Stift	Farbe und Funktion	
A-4	Gelb	Batterie
A-5	Blau/Weiß <sup>[1]</sup>	Stromsteuerung
A-7	Rot	Zündung (ACC)
A-8	Black	Erdungsanschluss (Masse)
B-1/B-2	Lila (+)/Lila/Schwarz (-)	Hinten rechts
B-3/B-4	Grau (+)/Grau/Schwarz (-)	Vorne rechts
B-5/B-6	Weiß (+)/Weiß/Schwarz (-)	Vorne links
B-7/B-8	Grün (+)/Grün/Schwarz (-)	Hinten links

<sup>[1]</sup> Max. 150 mA, 12 V

- Lautsprecherimpedanz: 4-8 Ω

### ⚠ ACHTUNG

Überprüfen Sie die folgende Bedingung, bevor Sie die handelsüblichen ISO-Stecker an das Gerät anschließen:

- Überprüfen Sie, ob die Stiftbelegung des Steckers mit dem JVC-Gerät übereinstimmt.
- Achten Sie besonders auf das Stromkabel.
- Wenn das Batteriekabel und das Zündkabel nicht übereinstimmen, tauschen Sie sie entsprechend aus.
- Verwenden Sie eine handelsübliche Schnittstelle, wenn Ihr Auto über kein Zündkabel verfügt.

## ■ Anschluss eines iPods/iPhones/Android-Geräts

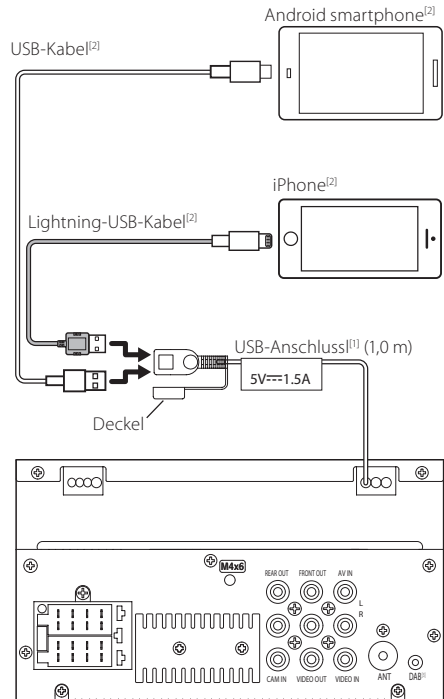

<sup>[1]</sup> Maximale USB-Stromversorgung:  
Gleichstrom 5 V --- 1,5 A

<sup>[2]</sup> Separat erhältlich

<sup>[3]</sup> nur KW-M180DBT

# Wissenswertes über dieses Gerät

## Weitere Informationen

### Verwendbare USB-Geräte

Dieses Gerät kann MPEG1/MPEG2/MPEG4/H.264/MKV/MP3/WMA/AAC/WAV/FLAC/OGG-Dateien wiedergeben, die auf einem USB-Massenspeicher gespeichert sind.

- Dateisystem: FAT16 / FAT32 / NTFS / exFAT
- Dieses Gerät kann insgesamt 9.999 Dateien und 320 Ordner erkennen (maximal 9.999 Dateien je Ordner).
- Die maximale Anzahl an Zeichen:
  - Ordernamen: 70 Zeichen
  - Dateinamen: 70 Zeichen
  - Tag: 70 Zeichen

### HINWEIS

- Wird das USB-Gerät an dieses Gerät angeschlossen, kann es durch das USB-Kabel aufgeladen werden.
- Bringen Sie das USB-Gerät an einer Stelle an, die einer sicheren Fahrweise nicht hinderlich ist.
- Sie können kein USB-Gerät über einen USB-Hub und einen Mehrfach-Kartenleser anschließen.
- Erstellen Sie Sicherheitskopien der Audiodateien, die in diesem Gerät verwendet werden. Je nach den Betriebsbedingungen des USB-Geräts werden diese Dateien möglicherweise gelöscht. Für Schäden durch gelöschte Speicherdaten wird keine Haftung übernommen.
- Im Lieferumfang dieses Geräts ist kein USB-Gerät enthalten. Sie müssen ein handelsübliches USB-Gerät kaufen.
- Setzen Sie den Deckel auf den USB-Anschluss auf, wenn er nicht verwendet wird.

### Abspielbare Audiodateien

Audioformat	Bitrate/(Bitzahl)	Abtastfrequenz
MP3 (.mp3)	16 – 320kbps, VBR	16 – 48 kHz
WMA (.wma)	16 – 320kbps	16 – 48 kHz
AAC-LC (.m4a)	16 – 320kbps	16 – 48 kHz
Linear PCM (WAVE) (.wav)	(16/24 bit)	8 – 192 kHz
FLAC (.flac)	(16/24 bit)	8 – 192 kHz
Vorbis (.ogg)	(16/24 bit)	8 – 192 kHz

- Dieses Gerät kann den ID3-Tag der Version 1.0/1.1/2.2/2.3/2.4 (für MP3) anzeigen.

### HINWEIS

- Mit DRM gesicherte WMA- und AAC-Dateien können nicht abgespielt werden.
- Auch wenn Audiodateien mit den oben genannten Standards übereinstimmen, kann es möglicherweise sein, dass sie nicht abgespielt werden - je nach Art oder Zustand des Datenträgers oder Geräts.

## Geignete Videodateien

Videoformat	Videocodec	Audiocodec
MPEG-1 (.mpg, .mpeg)	MPEG-1	MPEG Audio Layer 2
MPEG-2 (.mpg, .mpeg)	MPEG-2	MPEG Audio Layer 2
MPEG-4 (.mp4, .avi)	MPEG-4 (SP,ASP)	MP3, AAC-LC (2ch)
H.264/MPEG-4 AVC (.mp4, mkv, avi, .flv, .f4v)	H.264/MPG-4 AVC (BP/MP/HP)	MP3, AAC (2ch)
MKV (.mkv)	Video Format follows H.264/MPEG-4 AVC, MPEG4, XVID	MP3, AAC, Vorbis, FLAC

## Spezifikationen

### Bluetoothbereich

#### Frequenz

: 2,4 – 2,48 GHz

#### RF Output Power (E.I.R.P.)

: +8dBm (MAX)

### Audio-Sektion

#### Lautsprecherimpedanz

: 4 – 8 Ω

### Allgem.

#### Betriebsspannung

: 12-V-Gleichstrom-Autobatterie

### Urheberrechte

- Die Wortmarke Bluetooth® und die Logos sind registrierte Warenzeichen im Eigentum der Bluetooth SIG, Inc. und jede Verwendung dieser Marken durch die VCKENWOOD Corporation erfolgt unter Lizenz. Andere Warenzeichen und Handelsmarken sind Eigentum der jeweiligen Inhaber.
- Use of the Made for Apple badge means that an accessory has been designed to connect specifically to the Apple product(s) identified in the badge, and has been certified by the developer to meet Apple performance standards. Apple is not responsible for the operation of this device or its compliance with safety and regulatory standards. Please note that the use of this accessory with an Apple product may affect wireless performance.
- Apple, iPhone and Lightning are trademarks of Apple Inc., registered in the U.S. and other countries.
- Android is a trademark of Google LLC.
- Microsoft and Windows Media are either registered trademarks or trademarks of Microsoft Corporation in the United States and/or other countries.
- THIS PRODUCT IS LICENSED UNDER THE MPEG-4 VISUAL PATENT PORTFOLIO LICENSE FOR THE PERSONAL AND NON-COMMERCIAL USE OF A CONSUMER FOR (j) ENCODING VIDEO IN COMPLIANCE WITH THE MPEG-4 VISUAL STANDARD ("MPEG-4 VIDEO") AND/OR (jj) DECODING MPEG-4 VIDEO THAT WAS ENCODED BY A CONSUMER ENGAGED IN A PERSONAL AND NON-COMMERCIAL ACTIVITY AND/OR WAS OBTAINED FROM A VIDEO PROVIDER LICENSED BY MPEG LA TO PROVIDE MPEG-4 VIDEO. NO LICENSE IS GRANTED OR SHALL BE IMPLIED FOR ANY OTHER USE. ADDITIONAL INFORMATION INCLUDING THAT RELATING TO PROMOTIONAL, INTERNAL AND COMMERCIAL USES AND LICENSING MAY BE OBTAINED FROM MPEG LA, LLC. SEE [HTTP://WWW.MPEGLA.COM](http://www.mpegla.com).
- THIS PRODUCT IS LICENSED UNDER THE AVC PATENT PORTFOLIO LICENSE FOR THE PERSONAL USE OF A CONSUMER OR OTHER USES IN WHICH IT DOES NOT RECEIVE REMUNERATION TO (j) ENCODE VIDEO IN COMPLIANCE WITH THE AVC STANDARD ("AVC VIDEO") AND/OR (jj) DECODE AVC VIDEO THAT WAS ENCODED BY A CONSUMER ENGAGED IN A PERSONAL ACTIVITY AND/OR WAS OBTAINED FROM A VIDEO PROVIDER LICENSED TO PROVIDE AVC VIDEO. NO LICENSE IS GRANTED OR SHALL BE IMPLIED FOR ANY OTHER USE. ADDITIONAL INFORMATION MAY BE OBTAINED FROM MPEG LA, L.L.C. SEE [HTTP://WWW.MPEGLA.COM](http://www.mpegla.com)
- libFLAC  
Copyright (C) 2000-2009 Josh Coalson  
Copyright (C) 2011-2013 Xiph.Org Foundation
  - Redistribution and use in source and binary forms, with or without modification, are permitted provided that the following conditions are met:
  - Redistributions of source code must retain the above copyright notice, this list of conditions and the following disclaimer.

– Redistributions in binary form must reproduce the above copyright notice, this list of conditions and the following disclaimer in the documentation and/or other materials provided with the distribution.

Neither the name of the Xiph.org Foundation nor the names of its contributors may be used to endorse or promote products derived from this software without specific prior written permission.

THIS SOFTWARE IS PROVIDED BY THE COPYRIGHT HOLDERS AND CONTRIBUTORS "AS IS" AND ANY EXPRESS OR IMPLIED WARRANTIES, INCLUDING, BUT NOT LIMITED TO, THE IMPLIED WARRANTIES OF MERCHANTABILITY AND FITNESS FOR A PARTICULAR PURPOSE ARE DISCLAIMED. IN NO EVENT SHALL THE FOUNDATION OR CONTRIBUTORS BE LIABLE FOR ANY DIRECT, INDIRECT, INCIDENTAL, SPECIAL, EXEMPLARY, OR CONSEQUENTIAL DAMAGES (INCLUDING, BUT NOT LIMITED TO, PROCUREMENT OF SUBSTITUTE GOODS OR SERVICES; LOSS OF USE, DATA, OR PROFITS; OR BUSINESS INTERRUPTION) HOWEVER CAUSED AND ON ANY THEORY OF LIABILITY, WHETHER IN CONTRACT, STRICT LIABILITY, OR TORT (INCLUDING NEGLIGENCE OR OTHERWISE) ARISING IN ANY WAY OUT OF THE USE OF THIS SOFTWARE, EVEN IF ADVISED OF THE POSSIBILITY OF SUCH DAMAGE.

- libogg

Copyright (c) 2002, Xiph.org Foundation Redistribution and use in source and binary forms, with or without modification, are permitted provided that the following conditions are met:

– Redistributions of source code must retain the above copyright notice, this list of conditions and the following disclaimer.

– Redistributions in binary form must reproduce the above copyright notice, this list of conditions and the following disclaimer in the documentation and/or other materials provided with the distribution.

– Neither the name of the Xiph.org Foundation nor the names of its contributors may be used to endorse or promote products derived from this software without specific prior written permission.

THIS SOFTWARE IS PROVIDED BY THE COPYRIGHT HOLDERS AND CONTRIBUTORS "AS IS" AND ANY EXPRESS OR IMPLIED WARRANTIES, INCLUDING, BUT NOT LIMITED TO, THE IMPLIED WARRANTIES OF MERCHANTABILITY AND FITNESS FOR A PARTICULAR PURPOSE ARE DISCLAIMED. IN NO EVENT SHALL THE FOUNDATION OR CONTRIBUTORS BE LIABLE FOR ANY DIRECT, INDIRECT, INCIDENTAL, SPECIAL, EXEMPLARY, OR CONSEQUENTIAL DAMAGES (INCLUDING, BUT NOT LIMITED TO, PROCUREMENT OF SUBSTITUTE GOODS OR SERVICES; LOSS OF USE, DATA, OR PROFITS; OR BUSINESS INTERRUPTION) HOWEVER CAUSED AND ON ANY THEORY OF LIABILITY, WHETHER IN CONTRACT, STRICT LIABILITY, OR TORT (INCLUDING NEGLIGENCE OR OTHERWISE) ARISING IN ANY WAY OUT OF THE USE OF THIS SOFTWARE, EVEN IF ADVISED OF THE POSSIBILITY OF SUCH DAMAGE.

# Inhoud

Voor ingebruikname.....	87
De handleiding gebruiken.....	87
Voorzorgsmaatregelen .....	87
<b>Aan de Slag.....</b>	<b>88</b>
Klokinstellingen .....	88
<b>Basisinstellingen .....</b>	<b>89</b>
Functies van de knoppen op het voorpaneel.....	89
Basisbediening.....	89
Startscherm .....	89
Bronbedieningsscherm.....	89
<b>Digitale radio.....</b>	<b>90</b>
Basisbediening digitale radio .....	90
Digitale radio instellen .....	90
<b>Tuner .....</b>	<b>91</b>
Basisbediening van de tuner.....	91
Voorinstelstations.....	91
Radio instellen.....	91
<b>USB .....</b>	<b>92</b>
Vorbereiding.....	92
Weergaveopties.....	92
<b>iPhone .....</b>	<b>93</b>
Vorbereiding.....	93
Weergaveopties.....	93
<b>Externe Componenten.....</b>	<b>94</b>
Externe audio/video-spelers gebruiken.....	94
Achteruitzichtcamera.....	94
Leerfunctie van besturing op afstand .....	94
Omgekeerd met ATT.....	94
<b>Bluetooth .....</b>	<b>95</b>
Registreer uw mobiele telefoon bij het toestel.....	95
Ontvangen van een telefoongesprek.....	95
Voer een telefoongesprek uit .....	95
Bluetooth-audioapparaat afspelen.....	96
<b>Audio regelen.....</b>	<b>96</b>
Algemene audio regelen.....	96
<b>Installatie.....</b>	<b>97</b>
Vóór de installatie .....	97
De unit installeren .....	98
<b>Informatie over dit toestel.....</b>	<b>102</b>
Meer informatie .....	102
Specificaties.....	102
Auteursrechten.....	103

- Raadpleeg voor gedetailleerde bedieningen en informatie de INSTRUCTIEHANDLEIDING op de volgende website:

<<https://www.jvc.net/cs/car/>>.



# Voor ingebruikname

## De handleiding gebruiken

- De panelen die in deze handleiding worden weergegeven, zijn voorbeelden om een duidelijke uitleg van de werking te kunnen geven. Om die reden kunnen de panelen afwijken van de werkelijke panelen.
- Tijdens bedieningsprocedures geeft de vorm van de haken aan welke toets of knop u moet bedienen.  
< >: Geeft de naam van de paneelknoppen aan.  
[ ]: Geeft de naam van de tiptoetsen aan

 Dit symbool op het product betekent dat er belangrijke gebruiks- en onderhoudsinstructies in deze handleiding staan. Lees de instructies in deze handleiding zorgvuldig door.

## Vorzorgsmaatregelen

### WAARSCHUWING

-  **Neem de volgende voorzorgsmaatregelen om persoonlijk letsel of brand te voorkomen:**
  - Om kortsluiting te voorkomen plaats u nooit metalen voorwerpen (zoals munten of metalen gereedschappen) in het toestel of laat u deze in het toestel achter.
  - Kijk niet naar het scherm of richt uw ogen niet op het scherm als u langere tijd aan het rijden bent.
  - Raadpleeg uw JVC-dealer als u tijdens de installatie problemen ondervindt.
-  **Vorzorgsmaatregelen voor het gebruik van het toestel**
  - Neem wanneer u optionele toebehoren aanschaft contact op met uw JVC-dealer om te controleren of deze optionele toebehoren met uw model en in uw regio functioneren.
  - U kunt een taal selecteren om menu's, tags voor audiobestanden, enz. weer te geven. Zie **Aan de Slag (P.88)**
  - De functie Radio Data System of Radio Broadcast Data System werkt niet als deze functie niet wordt ondersteund door een te ontvangen radiostation.
-  **De monitor beschermen**
  - Om te voorkomen dat de monitor beschadigd raakt, mag u de monitor niet bedienen met een balpen of een soortgelijk hulpmiddel met scherpe punt.
-  **Het toestel reinigen**

Als er vlekken op het voorpaneel van dit toestel zitten, veeg deze er dan met een droge, zachte doek, zoals een siliconendoekje, van af. Als er hardnekkige vlekken op het voorpaneel zitten, veeg deze er dan eerst met een met neutraal reinigingsmiddel bevochtigde doek en vervolgens met een schone, zachte, droge doek van af.
-  **VOORZICHTIG**
  - Als u reinigingspray rechtstreeks op het toestel spuit, kunnen de mechanische onderdelen ervan beschadigd raken. Als u het voorpaneel met een harde doek of met een vluchtige vloeistof zoals thinner of alcohol afveegt, kunnen er krassen ontstaan of wordt opgedrukte tekst gewist.

### Uw toestel resetten

Als het toestel of het aangesloten toestel niet naar behoren werkt, moet het toestel worden gereset.



JVC

Resetknop

# Aan de Slag

## 1 Draai de contactsleutel van uw auto in de stand ACC.

Het apparaat is ingeschakeld, lees de waarschuwing en druk op "Agree" om het scherm te openen.



## 2 Druk op de knop < 🏠 > .

## 3 Raak [Settings] aan.

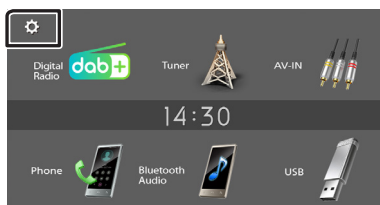

## 4 Raak de corresponderende toets aan en stel de waarde in.

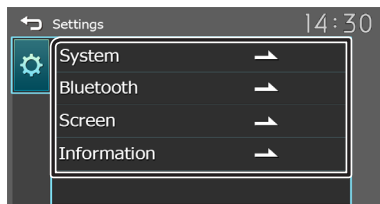

### [System]

#### [Beep Tone]

Activeer of deactiveert het toetsgeluid. „ON” (Standaard), „OFF”

#### [Language]

Selecteer de taal die wordt gebruikt voor het regelscherm en de in te stellen opties. De standaardinstelling is „English” (Engels).

#### [Time/Date]

Pas de kloktijd aan. (P.88)

#### [Clock Mode]

Selecteer het formaat van de tijdweergave. [12hr]/[24hr] (standaard)

#### [Steering Remote]

Stelt de gewenste functie in de de stuurafstandsbediening. Zie **Leerfunctie van besturing op afstand (P.94)**

#### [Parking Guidelines]

U kunt parkeerriichtlijnen weergeven om gemakkelijker parkeren in te schakelen wanneer u de versnelling om de achteruit-positie (R) zet. De standaardinstelling is „ON”

### [Guidelines SETUP]

Als u [ON] selecteert voor [Parking Guidelines], kunt u de parkeerriichtlijnen aanpassen.

### [Reverse with ATT (-20dB)]

Wanneer de versnelling naar achteruit (R) wordt geschakeld, wordt het volume van het apparaat aangepast. Standaard is „AAN”. Zie **Om de omgekeerde met ATT aan te passen (P.94)**

### [System Reset]

Raak [System Reset] aan en raak dan [YES] aan om alle instellingen terug te zetten naar de oorspronkelijke standaardinstellingen.

### [Bluetooth]

Geeft het Bluetooth-instellingenscherf weer. (P.95)

### [Screen]

#### [Dimmer]

Selecteer de dimmerstand. „High” (standaard), „Mid”, „Low”

#### [Demo]

Selecteer de demonstratiestand. De standaardinstelling is „ON”.

### [Information]

Om de Reverse aan te passen met ATTDIlays de softwareversie en het modelnummer van dit apparaat.

## 5 Raak [ 🏠 ] aan.

## Klokinstellingen

### ☑ Synchroniseren van de kloktijd met FM RDS

Activeer [RDS Clock Sync].  
Zie **Radio instellen (P.91)**.

### ☑ De klok handmatig aanpassen

#### 🔑 OPMERKING

- Deactiveer [RDS Clock Sync] voordat u de klok aanpast.

## 1 Druk op de knop < 🏠 > .

## 2 Raak [Settings] aan.

## 3 Raak [System] aan.

## 4 Raak [Time/Date] aan.

Klokscherm verschijnt.

## 5 Raak [▲] of [▼] aan om de kloktijd in te stellen.

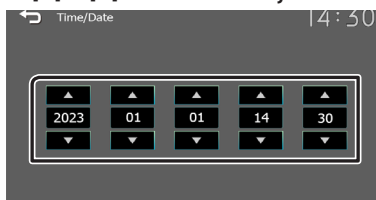

## 6 Raak [ 🏠 ] aan.



# Basisinstellingen

## Functies van de knoppen op het voorpaneel

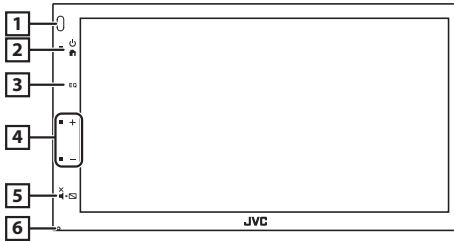

- 1 Sensor op afstand**
  - Ontvangt het signaal van de afstandsbediening.
- 2 (HOME)**
  - Geeft het START-scherm weer. **(P.89)**
  - Als de knop 1 seconde wordt ingedrukt, wordt het toestel uitgeschakeld.
  - Als het toestel is uitgeschakeld, wordt het ingeschakeld.
- 3 EQ**
  - Geeft het Geluidscherm weer.\* **(P.96)**
  - \* Het Geluidscherm wordt niet weergegeven tijdens het SETUP-scherm of op het lijstschermb, enz.
- 4 +, - (Volume)**
  - Regelt het volume. Het volume gaat tot niveau 15 wanneer u [ + ] ingedrukt houdt.
- 5 (MUTE, Display off) (Weergave uit)**
  - Dempt/herstelt het geluid.
  - Als de knop 1 seconde wordt ingedrukt, wordt het scherm uitgeschakeld.
  - Als het scherm is uitgeschakeld, raakt u het scherm aan om het scherm in te schakelen.
- 6 Reset**
  - Als de eenheid of de hiermee verbonden eenheid niet correct werkt, dan zal de eenheid terugkeren naar de fabrieksinstellingen wanneer er op deze knop wordt gedrukt.

## Basisbediening

### Het inschakelen van de stroom

1 Druk op de knop >.



### Uitschakelen van de stroom

1 Druk in en houd de -knop ingedrukt.

## Startscherm

1 Druk op de knop >.



START-scherm verschijnt.

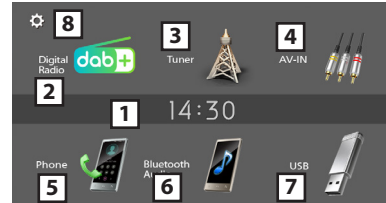

- 1 Klokweergave
- 2 Schakelt over naar de digitale radio-uitzending.  
\* **(P.90)**  
\* *Alleen KW-M180DBT*
- 3 Schakelt naar de radio-uitzending. **(P.91)**
- 4 Schakelt naar een extern component aangesloten op de AV-IN-aansluiting. **(P.94)**
- 5 Geeft het scherm Hands Free weer. **(P.95)**
- 6 Speelt een Bluetooth audio-speler af. **(P.96)**
- 7 **[USB]**   
Speelt bestanden af op een USB-apparaat. **(P.92)**  
**[iPhone]**   
Speelt een iPhone af. **(P.93)**
  - Wanneer de iPhone is verbonden.**[Mirroring]**   
Geeft het Spiegelscherm weer.
  - Wanneer er een Android-apparaat waarop de app „Mirroring OB for JVC“ is geïnstalleerd wordt aangesloten.
- 8 Geeft het INSTELLINGEN-scherm weer. **(P.88)**

## Bronbedieningsscherm



- 1 **[]**: Keert terug naar het vorige scherm.  
**[]**: Geeft het Geluidscherm weer. **(P.96)**

# Digitale radio (KW-M180DBT)

## Basisbediening digitale radio

1 Druk op de knop <🏠>.

2 Raak [Digital Radio] aan.

### 📄 Bronbedieningsscherm

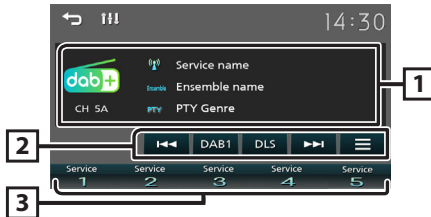

1 Informatie over de huidige zender wordt weergegeven:

Service naam, ensemble naam, PTY-genre, kanaal

2 **[DAB]** : Schakelt over van de voorinstelling van de digitale radio.

„DAB1”, „DAB2”, „DAB3”

**[DLS]** : Het scherm Dynamische labelsegment weergeven

[◀▶] : Selecteer een ensemble, service en component.

[☰] : Geeft het instellingsscherm voor Digitale radio weer. **(P.90)**

3 Roept de opgeslagen service op.

Als deze toets 2 seconden wordt aangeraakt, wordt de huidige zender in het geheugen opgeslagen.

### 📄 Sla een zender op

U kunt de huidige service in het geheugen opslaan.

1 Stem af op een zender die u in het geheugen wilt instellen.

2 Houd het [#] (#:1-5) waaronder u de zender wilt opslaan ingedrukt.

### 📄 Selecteer een opgeslagen service

1 Raak [#] (#:1-5) aan.

## Digitale radio instellen

1 Raak [☰] aan.

2 Stel de verschillende items als volgt in.

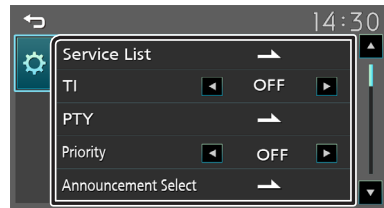

### [Service List]

Geeft het Servicelijst-scherm weer.

- [🏠] : Raak aan en raak vervolgens [Yes] aan voor de meest recente zenderlijst.

### [TI]

Schakelt automatisch naar de verkeersinformatie wanneer er een verkeersbericht wordt uitgezonden. „ON”, „OFF” (Standaard)

### [PTY]

Zoekt een programma aan de hand van het programmatype.

### [Priority]

Als de ontvangst van een door digitale radio geleverde dienst slecht wordt en dezelfde dienst door een Radio Data System wordt geleverd, wordt er automatisch geschakeld naar Radio Data System. „ON”, „OFF” (Standaard)

### [Announcement Select]

Schakelt over naar de aankondigingsdienst.

### [Related Service]

Wanneer u AAN selecteert, schakelt de unit over naar een gerelateerde service (indien deze bestaat) wanneer een DAB-servicenetwerk niet beschikbaar is. De standaardwaarde is „OFF”.

### [Antenna Power]

Stelt de voeding in op de antenne voor digitale radio. Stel deze optie in op „ON” als de antenne voor digitale radio is uitgerust met een versterker. De standaardinstelling is „ON”.

3 Raak [🏠] aan.

# Tuner

## Basisbediening van de tuner

1 Druk op de knop <img alt="Home icon" data-bbox="238 105 278 125"/>.

2 Raak [Radio] aan.

### Bronbedieningsscherm

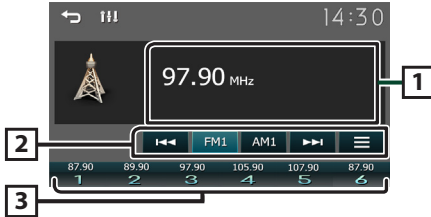

1 Geeft de informatie van de huidige zender weer: PS-naam, Frequentie, PTY-genre, indicatoren

2 **[FM]** : Wisselt de FM band.  
„FM1 “, „ FM2 “, „FM3 “

**[AM]** : Wisselt de AM band.  
„AM1 “, „ AM2 “

**[<img alt="Left arrow" data-bbox="94 413 115 434"/> <img alt="Right arrow" data-bbox="115 413 136 434"/>]** : Stemt automatisch af op een zender met goed ontvangst.

**[<img alt="Menu icon" data-bbox="94 445 115 462"/>]** : Geeft het Radioinstelscherm weer. **(P.91)**

3 Roept de opgeslagen zender op.  
Als deze toets 2 seconden wordt aangeraakt, wordt de huidige zender in het geheugen opgeslagen.

## Voorinstelstations

### Automatisch geheugen

U kunt 6 zenders vooraf instellen voor de huidige band (FM1/FM2/FM3/AM1/AM2).

1 Raak **[FM]** of **[AM]** aan om de band te selecteren.

2 Raak **[<img alt="Menu icon" data-bbox="136 680 157 697"/>]** aan.

3 Raak **[Auto Store]** aan.

De lokale zenders met de sterkste signalen worden automatisch gevonden en opgeslagen.

### Handmatig geheugen

U kunt de huidig ontvangen zender in het geheugen opslaan.

1 Stem af op een zender die u vooraf wilt instellen.

2 Raak aan en houdt **[#]** (#:1-6) vast waarin u de zender wilt opslaan.

### Oproepen van voorkeurzenders

1 Raak **[#]** (#:1-6) aan.

## Radio instellen

1 Raak **[<img alt="Menu icon" data-bbox="586 106 607 125"/>]** aan.

2 Stel de verschillende items als volgt in.

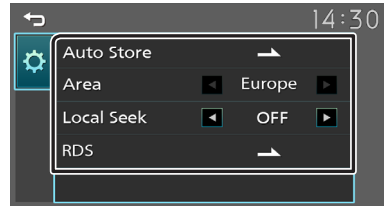

### **[Auto Store]**

Zoekt automatisch naar de 6 stations met de sterkste signalen voor de geselecteerde band en slaat deze op.

„Auto Store“ verschijnt.

### **[Area]**

„Europe“ : AM/FM intervallen: 9 kHz/50 kHz.

### **[Local Seek]**

Stemt alleen af op de zenders met voldoende signaalsterkte. **(LOC)** indicator licht op.

„ON“, „OFF“ (Standaard)

### **[RDS] \*1**

Geeft het RDS-instellingenschermb weer.

### **[AF]**

Wanneer de ontvangstkwaliteit slecht is, wordt automatisch overgeschakeld op de zender die hetzelfde programma uitzendt in hetzelfde Radio Data System-netwerk.

„ON“ (Standaard), „OFF“

### **[TA]**

Schakelt automatisch naar de verkeersinformatie wanneer er een verkeersbericht wordt uitgezonden. **(TI)**-lampje gaat branden.)

„ON“, „OFF“ (Standaard)

### **[RDS Clock Sync]**

Het synchroniseren van de tijdgegevens van de zender van het Radio-datasysteem en de klok van deze eenheid.

„ON“ (Standaard), „OFF“

### **[PTY]**

Selecteer een programmatype.

### **[PTY Seek]**

Zoekt een programma aan de hand van het programmatype.

\*1 Alleen FM

3 Raak **[<img alt="Home icon" data-bbox="586 911 607 929"/>]** aan.

# USB

## Vorbereiding

### ■ Een USB-apparaat aansluiten

- 1 Verwijder de dop van het USB-aansluitpunt.
- 2 Sluit het USB-apparaat via de USB-kabel aan.

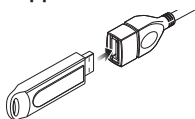

Het toestel leest de disk en het afspelen begint.

### ■ Het USB-apparaat loskoppelen:

- 1 Druk op de knop <img alt="Home button icon" data-bbox="240 308 265 325"/>.
- 2 Raak een andere bron dan [USB] aan.
- 3 Ontkoppel het USB-apparaat.

### ■ Bruikbaar USB-apparaat

Dit apparaat kan MPEG1/MPEG2/MPEG4/H.264/ MKV/MP3/WMA/AAC/WAV/FLAC en OGC-bestanden die op een USB-geheugen zijn opgeslagen afspelen. (P.102)

## Weergaveopties

### ■ Regel de muziek op het bronregelscherm.

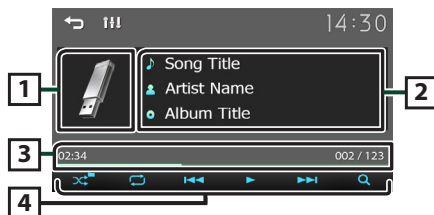





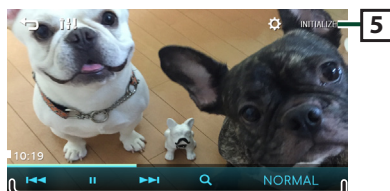

- 1 De omslag van het momenteel afgespeelde bestand wordt weergegeven.
- 2 Informatie over het huidige bestand wordt weergegeven.
- 3 Speelduur/bestandsnummer  
**Afspelstijdbalk**: Voor bevestiging van huidige afspelpositie.
- 4 : Selecteert willekeurige afspelstand.  
: Selecteert repeatstand.  
: Speelt of pauzeert.  
: Zoekt de vorige/volgende inhoud.  
Aangerakt houden om snel vooruit of snel achteruit te gaan.  
: Zoekt bestand. (P.92)

### ■ Voor het afspelen van Video

- 1 Wanneer de bedieningsknoppen niet worden weergegeven op het scherm, raak dan het scherm aan.





- 5 : U kunt de beeldkwaliteit aanpassen in het videoscherm.  
**[INITIALIZE]**: Om de aanpassing te wissen.
- 6 , : Speelt of pauzeert.  
, : Zoekt de vorige/volgende inhoud.  
Aangerakt houden om snel vooruit of snel achteruit te gaan.  
: Zoekt bestand. (P.92)  
**[NORMAL]/[16:9]/[4:3]**: Selecteer een schermstand.

### ■ Een nummer op een lijst selecteren (Zoekt bestand)

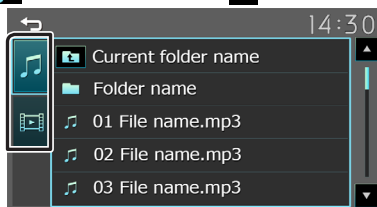
- 1 Raak  aan.
- 2 Selecteer of u wilt zoeken op audiobestanden  of videobestanden .



- 3 Raak  aan om een niveau omhoog te gaan.
  - 4 Raak de gewenste map aan.  
Wanneer u een map aanraakt, wordt diens inhoud weergegeven.  
• Raak  aan om een niveau omhoog te gaan.
  - 5 Raak het gewenste onderdeel in het inhoudsoverzicht aan.  
Het afspelen begint.
- OPMERKING**
- Het bronbedieningsscherm verschijnt wanneer u  aanraakt op het hoogste niveau.

## Vorbereiding

### Aansluiten iPhone

- Voor meer informatie over het aansluiten van iPhone, zie pagina 101

### 1 Verwijder de dop van het USB-aansluitpunt.

### 2 Sluit de iPod/iPhone aan.

Het toestel leest de disk en het afspelen begint.

### De iPhone loskoppelen

### 1 Druk op de knop <math>\leftarrow \text{Home} \rightarrow \text{>}</math>.

### 2 Raak een andere bron dan [iPhone] aan.

### 3 Ontkoppel de iPhone.

### Aansluitbare iPhone

De volgende modellen kunnen op dit toestel worden aangesloten.

Gemaakt voor

- |                              |                     |
|------------------------------|---------------------|
| • iPhone 14 Pro Max          | • iPhone 11 Pro Max |
| • iPhone 14 Pro              | • iPhone 11 Pro     |
| • iPhone 14 Plus             | • iPhone 11         |
| • iPhone 14                  | • iPhone XS Max     |
| • iPhone 13 Pro Max          | • iPhone XS         |
| • iPhone 13 Pro              | • iPhone XR         |
| • iPhone 13                  | • iPhone X          |
| • iPhone 13 mini             | • iPhone 8 Plus     |
| • iPhone 12 Pro Max          | • iPhone 8          |
| • iPhone 12 Pro              | • iPhone 7 Plus     |
| • iPhone 12                  | • iPhone 7          |
| • iPhone 12 mini             | • iPhone SE         |
| • iPhone SE (2nd generation) | • iPhone 6s Plus    |
|                              | • iPhone 6s         |

### OPMERKING

- Als u muziek gaat afspelen nadat u de iPhone hebt aangesloten, wordt eerst de muziek afgespeeld die door de iPhone is afgespeeld.
- Plaats de dop op het USB-aansluitpunt wanneer u deze niet gebruikt.

## Weergaveopties

### Regel de muziek op het bronregelscherm.



1 Illustraties (Worden weergegeven als het liedje illustraties bevat)

2 Informatie over het huidige bestand wordt weergegeven.

3 Speelduur/bestandsnummer  
**Afspeeltijdbalk** : Voor bevestiging van huidige afspeelpositie.

4 [ ] : Selecteert willekeurige afspeelstand.

[ ] : Selecteert repeatstand.

[ ] : Speelt of pauzeert.

[ ] : Zoekt de vorige/volgende inhoud.  
Aangeraakt houden om snel vooruit of snel achteruit te gaan.

[ ] : Zoekt naar inhoud. (P.93)

### Selecteren van inhoud in een lijst

### 1 Raak [ ] aan.

### 2 Raak het gewenste onderdeel aan.

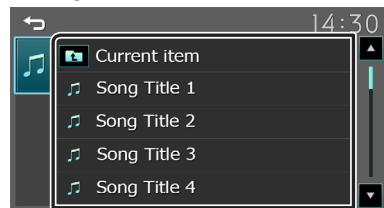

Wanneer u een categorie aanraakt, wordt diens inhoud weergegeven.

### 3 Raak het gewenste onderdeel in het inhoudsoverzicht aan.

Het afspelen begint.

- Raak [ ] aan om een niveau omhoog te gaan.

### OPMERKING

- Het bronbedieningsscherm verschijnt wanneer u [ ] aanraakt op het hoogste niveau.

# Externe Componenten

## Externe audio/video-spelers gebruiken

### Het afspelen begint

- 1 Koppel een extern component aan het AV-IN-ingangsaansluitpunt. (P.100)
- 2 Druk op de knop <img alt="Home button icon" data-bbox="245 178 265 198"/>.
- 3 Raak [AV-IN] aan.
- 4 Zet het gekoppelde component aan en begin de bron af te spelen.

### Voor het afspelen van Video

- 1 Wanneer de bedieningsknoppen niet worden weergegeven op het scherm, raak dan het scherm aan.

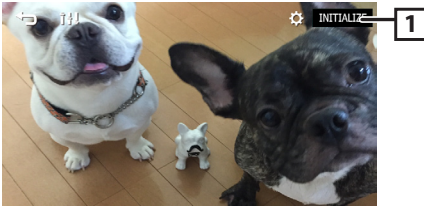

- 1 <img alt="Gear icon" data-bbox="105 475 125 495"/>: U kunt de beeldkwaliteit aanpassen in het videoscherm.  
<img alt="Initialize icon" data-bbox="105 505 125 525"/>: Om de aanpassing te wissen.

### OPMERKING

- Wanneer het beeld van de achteruitkijkcamera op het AV-IN-scherm wordt weergegeven, verdwijnt het beeld weergegeven via de Visuele Outputaansluiting.

## Achteruitzichtsamera

Om een achteruitkijkcamera te gebruiken, is de OMGEKEERD geleide koppeling nodig. Om een achteruitkijkcamera aan te sluiten. (P.100)

### Het beeld van de achteruitkijkcamera weergeven

Het achteruitkijk-scherm wordt weergegeven wanneer u de versnelling schakelt naar de achteruitpositie (R).



- De eerste aanraking verwijdert de waarschuwing en de tweede aanraking sluit het camerascherm.

## Leerfunctie van besturing op afstand

Leerfunctie van stuurafstandsbediening  
Deze functie is alleen beschikbaar wanneer uw voertuig is uitgerust met de elektrische stuurafstandsbediening.

- 1 Druk op de knop <img alt="Home button icon" data-bbox="695 193 715 213"/>.
- 2 Raak [Settings] aan.
- 3 Raak [System] aan.
- 4 Raak [Steering Remote] aan.
- 5 Raak de functie aan die u wilt instellen.
- 6 Houd de knop van de afstandsbediening van de besturing ingedrukt.

### OPMERKING

- U kunt de eenheid alle knoppen tegelijk laten leren. In dat geval drukt u één voor één op de knoppen en nadat u ze allemaal hebt ingedrukt, raakt u <img alt="Home button icon" data-bbox="855 385 875 405"/> aan in het instelscherm van de stuurafstandsbediening.

- 7 Herhaal stappen 5 en 6 indien nodig.

- 8 Raak <img alt="Home button icon" data-bbox="315 445 335 465"/> aan.

### OPMERKING

- Raak [Initialize] aan en raak dan [Yes] aan om alle markeringen in te stellen op de oorspronkelijke standaardpositie.

## Omgekeerd met ATT (-20dB)

Wanneer de versnelling naar achteruit (R) wordt geschakeld, wordt het volume van het apparaat aangepast.

- 1 Druk op de knop <img alt="Home button icon" data-bbox="695 629 715 649"/>.
- 2 Raak [Settings] aan.
- 3 Raak [System] aan.
- 4 Raak [Reverse with ATT] aan.
- 5 Raak [◀] of [▶] ingesteld op [ON]/[OFF].

### OPMERKING

- De instelwaarde is ON (standaard).

# Bluetooth

## Registreer uw mobiele telefoon bij het toestel

U kunt uw Bluetooth-smartphone gebruiken als deze aan dit toestel is gekoppeld.

**1** Zet de Bluetooth-functie op uw smartphone/mobiele telefoon aan.

**2** Zoek de unit ("KW-M180DBT"/"KW-M180BT") vanaf uw smartphone/mobiele telefoon.

Als er een PIN-code is vereist, voert u de pincode („0000“) in.

-  verschijnt wanneer de Bluetooth-smartphone verbonden is.

### Het apparaat ontkoppelen

- Zet de Bluetooth-functie op uw smartphone/mobiele telefoon uit.
- Zet het contactslot uit.

## Ontvangen van een telefoongesprek

**1** Raak  aan.

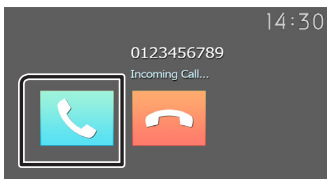

- : Wijs een inkomend telefoongesprek a

### Bediening tijdens een telefoongesprek

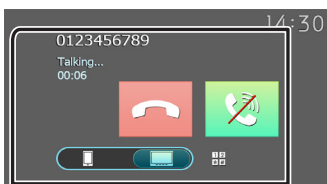

 Een telefoongesprek beëindigen

 Hou je stem stil.

 U kunt tonen versturen door de gewenste toetsen op het scherm aan te raken.

- Raak  aan om het venster te sluiten.

 Schakelt de weergave van de stem tussen smartphone/mobiele telefoon en luidspreker.

• **Het volume van de ontvanger aanpassen**

Druk op de <+> of <-> knop.

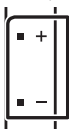

## Voer een telefoongesprek uit

**1** Druk op de knop  > .

**2** Raak [Phone] aan.

**3** Zie de tabel hieronder voor elk van de methodes.

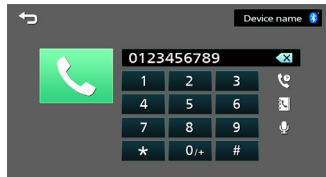

### Bellen door een telefoonnummer in te voeren

1) Voer een telefoonnummer in met de nummertoeetsen.



2) Raak  aan.

Een telefoongesprek tot stand brengen

- Raak  aan om de laatste invoer te wissen.

### Bellen via de gesprekslijsten

1) Raak  aan.

2) Raak  (inkomende gesprekken),  (uitgaande gesprekken),  (gemiste gesprekken) aan.

3) Selecteer het telefoonnummer uit de lijst.  
Een telefoongesprek tot stand brengen

### Bellen via het telefoonboek

1) Raak  aan.

2) Selecteer de naam uit de lijst.

Een telefoongesprek tot stand brengen

- : Bijwerken van het telefoonboek.

Druk op deze knop nadat u iets in het telefoonboek van uw smartphone/mobiele telefoon hebt gewijzigd.

## Oproep Wachten

Wanneer u een nieuw gesprek ontvangt terwijl u aan de telefoon praat:

1) Raak  , de huidige oproep wordt in de wacht gezet en u kunt de nieuw ontvangen oproep beantwoorden.

2) Elke keer dat je  aanraakt, verandert de beller naar de andere.

3) Als u  aanraakt tijdens het wachten van een oproep, weigert u een inkomend gesprek.

4) Als u  aanraakt, wanneer iemand in de wacht staat, zal het huidige gesprek eindigen met het gesprek dat in de wacht staat.





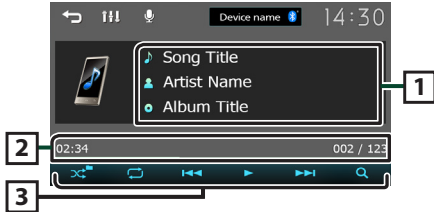

5) Raak  demp je stem.

## Bluetooth

### Bluetooth-audioapparaat afspelen

- 1 Druk op de knop .
  - 2 Raak [Bluetooth Audio] aan.
-  **Bronbedieningsscherm**





- 1 Informatie over het huidige bestand wordt weergegeven.
- 2 Speelduur/bestandsnummer  
**Afspelbalk** : Voor bevestiging van huidige afspelpositie.
- 3  : Selecteert willekeurige afspelstand.  
 : Selecteert repeatstand.  
 ,  : Speelt of pauzeert.  
 ,  : Zoekt de vorige/volgende inhoud.  
Aangeraakt houden om snel vooruit of snel achteruit te gaan.  
 : Zoekt bestand. (**P.96**)

#### **OPMERKING**

- Aanduidingen in het display en hun beschikbaarheid kan verschillen afhankelijk van het aangesloten toestel.

#### **Selecteren van inhoud in een lijst**

- 1 Raak [  ] aan.
- 2 Raak het gewenste onderdeel aan.  
Wanneer u een categorie aanraakt, wordt diens inhoud weergegeven.
- 3 Raak het gewenste onderdeel in het inhoudsoverzicht aan.  
Het afspelen begint.
  - Raak  aan om een niveau omhoog te gaan.

#### **OPMERKING**

- Het bronbedieningsscherm verschijnt wanneer u  aanraakt op het hoogste niveau.

## Audio regelen

U kunt verschillende instellingen veranderen, zoals geluidbalans of subwooferniveau.

- 1 Druk op de <EQ>-knop.
- 2 Zie de tabel hieronder voor elke bedieningsmethode.

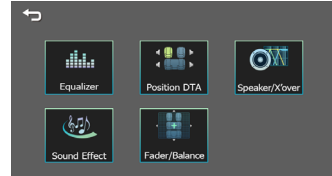

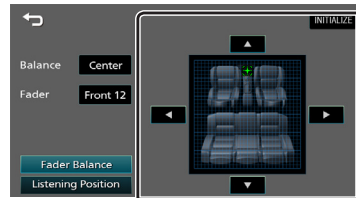

### Algemene audio regelen

- 1 Druk op de <EQ>-knop.
- 2 Raak [Fader / Balance] aan.
- 3 Stel de verschillende items als volgt in.



#### **[Fader Balance]**

**Balance**   Pas de linker en rechter volumebalans aan.

15 (links) tot 15 (rechts)

**Fader**   Aanpassen van de voorste en achterste volumebalans.

15 (voorkant) tot 15 (achterkant)

**[INITIALIZE]** Om de aanpassing te wissen.

#### **[Listening Position]**

**[  ]** Selecteer een luisterpositie vanuit „Front Left“, „Front All“, „Front Right“, en „Middle“.

**[INITIALIZE]** Om de aanpassing te wissen.



# Installatie

## Vóór de installatie

Neem vóór de installatie van dit toestel de volgende voorzorgsmaatregelen in acht.

### ▲WAARSCHUWINGEN

- Als u de ontstekingskabel (rood) en de accukabel (geel) op het chassis van de auto (massa) aansluit, kunt u kortsluiting veroorzaken waardoor brand kan ontstaan. Sluit deze kabels altijd aan op de voedingsbron die door de zekeringkast loopt.
- Verwijder niet de zekering van de ontstekingskabel (rood) en de accukabel (geel). De voeding moet zijn aangesloten op de kabels via de zekering.

### ▲LET OP

- Installeer dit toestel in de console van uw auto. Raak het metalen deel van dit toestel tijdens of na het gebruik niet aan. Metalen delen zoals de behuizing worden heet.

### 🔧 OPMERKING

- De montage en aansluiting van dit product vereist kennis en ervaring. Voor uw eigen veiligheid dient u de montage en aansluiting over te laten aan deskundigen.
- Zorg dat het toestel op een negatieve 12 Volt gelijkstroomvoeding is geara'd.
- Installeer het toestel niet op plaatsen die aan direct zonlicht, overmatige hitte of vochtigheid blootstaan. Vermijd tevens zeer stoffige plaatsen of plaatsen waar het toestel nat zou kunnen worden.
- Gebruik geen eigen schroeven. Gebruik uitsluitend de bij het toestel geleverde schroeven. Het gebruik van verkeerde schroeven kan het toestel beschadigen.
- Als het contact van uw auto geen ACC-stand heeft, moet u de ontstekingskabel met een spanningsbron verbinden die gelijk met het contact van de auto wordt in- of uitgeschakeld. Als u de ontstekingskabel verbindt met een spanningsbron waar constant spanning op staat, zoals een accukabel, kan de accu leeglopen.
- Als de console een deksel heeft, moet u er bij de installatie van het toestel op letten dat het voorpaneel het deksel bij het openen en sluiten niet raakt.
- Als de zekering is doorgebrand, controleert u eerst of de kabels elkaar niet raken en zo een kortsluiting veroorzaken en vervangt u de zekering door een nieuwe met dezelfde stroomsterkte.
- Isoleer niet-aangesloten kabels met isolatieband of ander geschikt materiaal. Voorkom kortsluiting door de kapjes op het uiteinde van de niet-aangesloten kabels of aansluitingen niet te verwijderen.

- Zet de bedrading met behulp van de kabelklemmen en wikkel de vinyltape rond de draden die in contact komt met de metalen delen en om te voorkomen dat de draden om kortsluiting te voorkomen.
- Sluit de luidsprekerkabels correct aan op de corresponderende aansluitingen. Het toestel kan beschadigd raken of niet langer werken als u de ⊖-draden deelt of deze aardt met een metalen onderdeel van het voertuig.
- Indien er maar twee luidsprekers op het systeem worden aangesloten, moeten de connectors óf op de beide voorste uitgangen óf op de beide achterste uitgangen worden aangesloten (verwissel voor en achter niet). Indien u bijvoorbeeld de ⊕ connector van de linker luidspreker op een voorste uitgang aansluit, mag u de ⊖ connector niet op een achterste uitgang aansluiten.
- Controleer na het installeren van het toestel of de remlichten, richtingaanwijzers, ruitenwissers etc. van de auto correct functioneren.
- Installeer het toestel zodanig dat een maximale hoek van 30° wordt bereikt.
- Duw niet te hard op het paneeloppervlak tijdens de installatie van het toestel in het voertuig. Dit kan leiden tot krassen, schade of het niet meer goed functioneren.
- De ontvangst wordt mogelijk slechter wanneer zich metalen voorwerpen in de buurt van de Bluetooth-antenne bevinden.

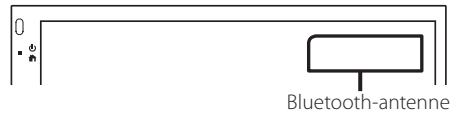

## Installatie

### ■ Meegeleverde accessoires voor installatie

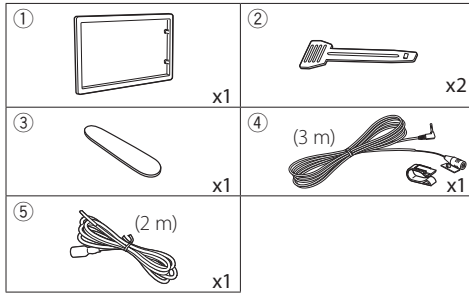

### ■ Installatieprocedure

- 1) Voorkom kortsluiting door de sleutel uit het contactslot te verwijderen en de  $\ominus$  aansluiting van de accu los te koppelen.
- 2) Verbind de juiste in- en uitgangskabels van elk toestel.
- 3) Sluit de kabel op de bedradingsbundel aan.
- 4) Neem connector B op de bedradingsbundel en sluit deze aan op de luidsprekerconnector van uw auto.
- 5) Neem connector A op de bedradingsbundel en sluit deze aan op de externe spanningsconnector op uw auto.
- 6) Sluit de connector van de bedradingsbundel op het toestel aan.
- 7) Installeer het toestel in uw auto.
- 8) Sluit de  $\ominus$ -pool van de batterij weer aan.
- 9) Druk op de resetknop.

## De unit installeren

### ■ Niet-Japanse auto's

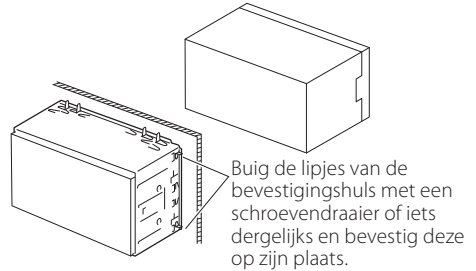

### OPMERKING

- Zorg ervoor dat het toestel stevig op zijn plaats zit. Als het toestel instabiel is, kan het slecht functioneren (het geluid kan bijvoorbeeld overslaan).

### ■ Afwerkingsplaat

- 1) Bevestig de accessoire ① aan het toestel.

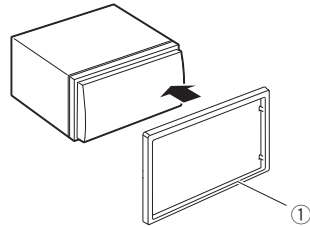

## Installatie

### De microfoon

- 1) Controleer de installatiepositie van de microfoon (accessoire ④).
- 2) Reinig het installatieoppervlak.
- 3) Verwijder de beschermstrook van de microfoon (accessoire ④) en plak de microfoon op de plek die hieronder wordt getoond.
- 4) Leid de microfoonkabel tot aan de handsfreetkit en zet de kabel op verschillende plaatsen vast met tape of vergelijkbaar materiaal.
- 5) Verstel de microfoon (accessoire ④) in de richting van de bestuurder.

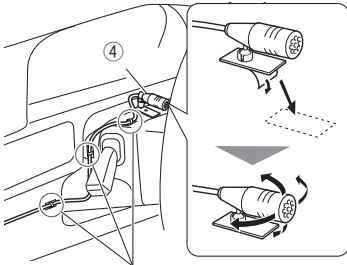

Bevestig de kabel met in de handel verkrijgbare tape.

### OPMERKING

- Wissel, zo nodig, de klemmen om.

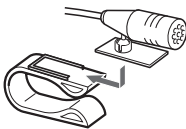

### Verwijderen van de afwerkingsplaat

- 1) Gebruik de extractiesleutel (accessoire ③) om de vier lipjes los te wippen (twee aan de linkerkant, twee aan de rechterkant).

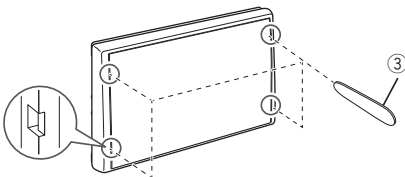

- 2) Trek de afwerkingsplaat naar voren.

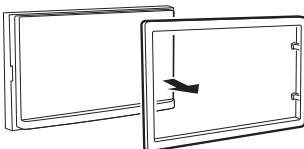

### De eenheid verwijderen

- 1) Zie stap 1 in "Verwijderen van de afwerkingsplaat" voor het verwijderen van het inbouwframe.
- 2) Plaats de extractiesleutel (accessoire ②) diep in de opening, zoals afgebeeld. (Het uitsteksel aan het eind van de extractiesleutel moet naar de eenheid toe wijzen.)

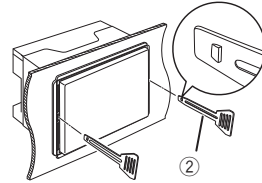

- 3) Wanneer de geplaatste extractiesleutel vastzit, steekt u de andere extractiesleutel in de opening.

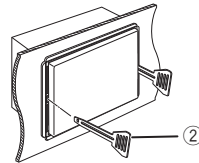

- 4) Trek de eenheid half uit.

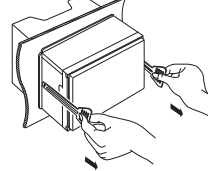

### OPMERKING

- Wees voorzichtig om verwonding door de klampennen op de uitbouw sleutel te vermijden.
- 5) Trek het toestel met uw handen geheel naar voren en let op dat u het toestel niet laat vallen.

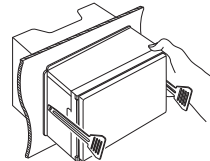

# Installatie

## Verbinden van kabels met aansluitingen

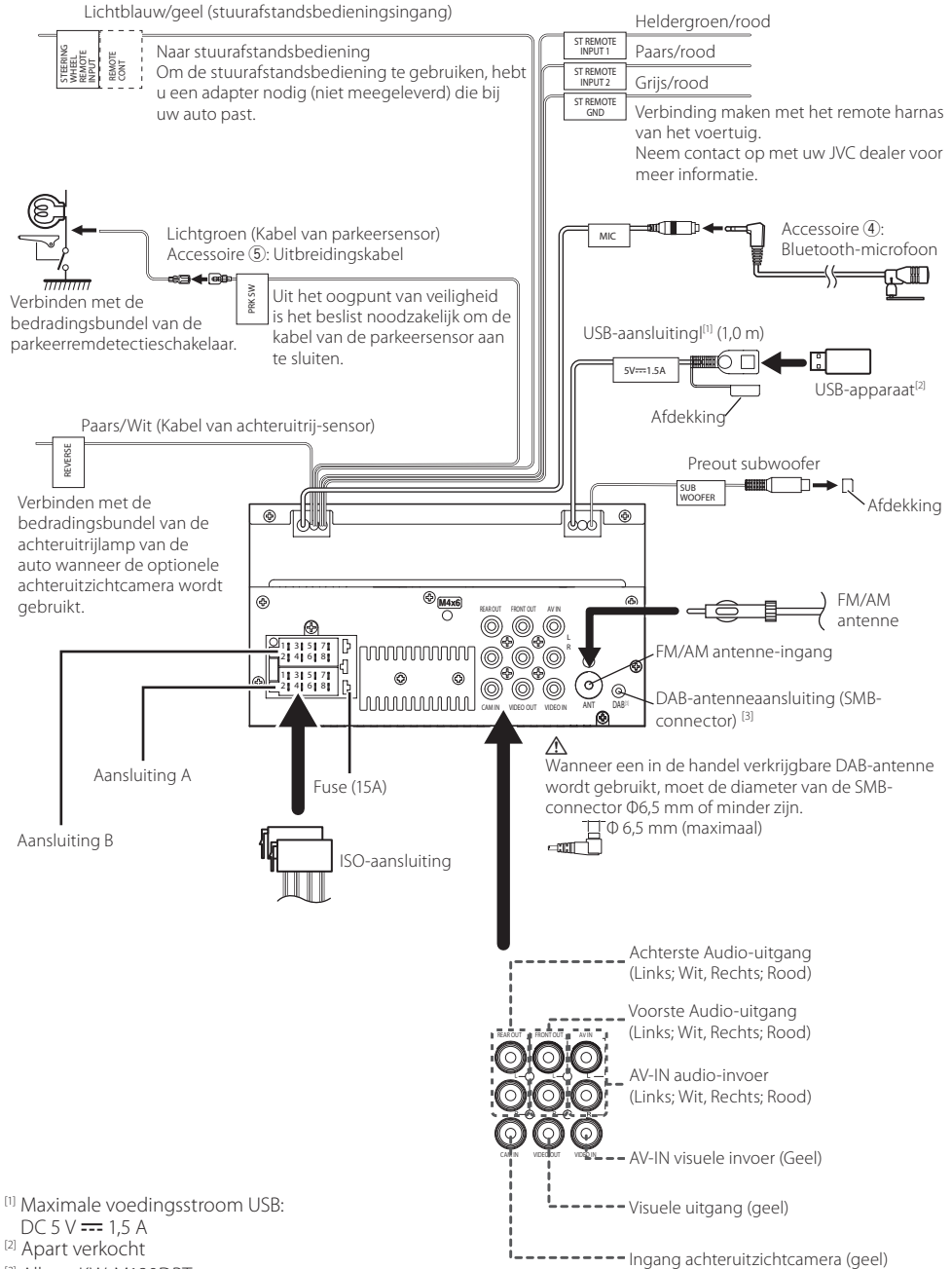

<sup>(1)</sup> Maximale voedingsstroom USB: DC 5 V  $\pm$  1,5 A

<sup>(2)</sup> Apart verkocht

<sup>(3)</sup> Alleen KW-M180DBT

# Installatie

## ■ Kabelboomstekker functieids

Pen	Kleur en functie	
A-4	Geel	Accu
A-5	Blauw/wit <sup>[1]</sup>	Spanningsregeling
A-7	Rood	Ontsteking (ACC)
A-8	Zwart	Aardaansluiting (massa)
B-1/ B-2	Paars (+) / Paars/Zwart (-)	Rechts achter
B-3/ B-4	Grijs (+) / Grijs/Zwart (-)	Rechts voor
B-5/ B-6	Wit (+) / Wit/Zwart (-)	Links voor
B-7/ B-8	Groen (+) / Groen/Zwart (-)	Links achter

<sup>[1]</sup> Max. 150 mA, 12 V

- Luidsprekerimpedantie: 4-8 Ω

### ⚠ VOORZICHTIG

Controleer de volgende toestand, voordat u de vrij verkrijgbare ISO-aansluitingen aansluit aan het apparaat:

- Wees ervan verzekerd dat de pinbezetting van de aansluiting past op het JVC-apparaat.
- Let extra op de stroomkabel.
- In het geval dat de batterijkabel en de ontstekingskabel niet overeenkomen, wissel ze dan.
- In het geval dat de auto geen ontstekingskabel heeft, gebruik dan een vrij verkrijgbare interface.

## ■ Aansluiten van een iPhone/Android

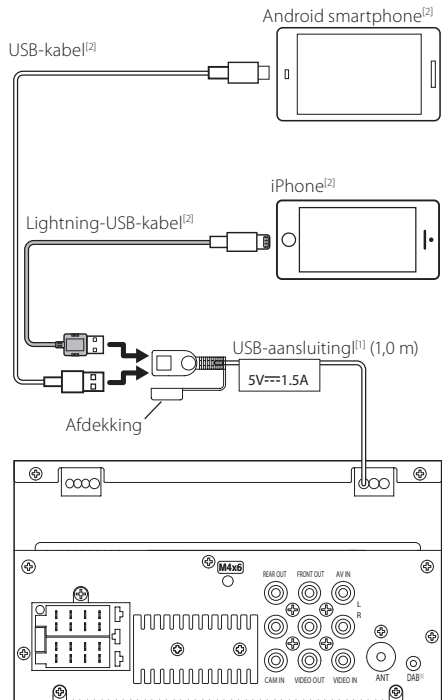

<sup>[1]</sup> Maximale voedingsstroom USB :

DC 5 V --- 1,5 A

<sup>[2]</sup> Apart verkocht

<sup>[3]</sup> Alleen KW-M180DBT

# Informatie over dit toestel

## Meer informatie

### Bruikbaar USB-apparaat

Dit apparaat kan MPEG1/MPEG2/MPEG4/H.264/MKV/MP3/WMA/AAC/WAV/FLAC en OGC-bestanden die op een USB-geheugen zijn opgeslagen afspelen.

- Bestandssysteem: FAT16 / FAT32 / NTFS / exFAT
- Deze eenheid kan in totaal 9.999 bestanden en 320 mappen herkennen (een maximum van 9.999 bestanden per map).
- Het maximum aantal tekens:
  - Mapnamen : 70 tekens
  - Bestandsnamen : 70 tekens
  - Label : 70 tekens

### OPMERKING

- Als het USB-apparaat op dit toestel is aangesloten, kan het via de USB-kabel worden opgeladen.
- Installeer het USB-apparaat op een plaats waar het veilig rijden niet belemmert.
- U kunt een USB-apparaat niet via een USB-hub en multikaartlezer aansluiten.
- Maak back-ups van de audiobestanden die u op dit toestel hebt gebruikt. De bestanden kunnen worden gewist afhankelijk van de bedieningsvoorwaarden van het USB-apparaat.
- Wij vergoeden geen schade die op enigerlei wijze door het wissen van gegevens ontstaat.
- Dit toestel is niet met een USB-apparaat uitgerust. U moet zelf een in de handel verkrijgbaar USB-apparaat aanschaffen.
- Plaats de dop op het USB-aansluitpunt wanneer u deze niet gebruikt.

### Afspeelbare audiobestanden

Audioformaat	Bitsnelheid/ (bit-telling)	Bemonsteringsfrequentie
MP3 (.mp3)	16 – 320kbps, VBR	16 – 48 kHz
WMA (.wma)	16 – 320kbps	16 – 48 kHz
AAC-LC (.m4a)	16 – 320kbps	16 – 48 kHz
Linear PCM (WAVE) (.wav)	(16/24 bit)	8 – 192 kHz
FLAC (.flac)	(16/24 bit)	8 – 192 kHz
Vorbis (.ogg)	(16/24 bit)	8 – 192 kHz

- Dit apparaat kan ID3 Label Versie 1.0/1.1/2.2/2.3/2.4 (voor MP3) tonen.

### OPMERKING

- WMA en AAC kunnen niet worden afgespeeld indien gedekt door DRM.
- Hoewel de audiobestanden voldoen aan de hierboven vermelde standaarden, is het mogelijk dat ze niet kunnen worden afgespeeld. Dit is afhankelijk van het type media of apparaat en de omstandigheden waaronder de media of het apparaat wordt gebruikt.

### Aanvaardbare videobestanden

Videoformaat	Video-codec	Audio-codec
MPEG-1 (.mpg, .mpeg)	MPEG-1	MPEG Audio Layer 2
MPEG-2 (.mpg, .mpeg)	MPEG-2	MPEG Audio Layer 2
MPEG-4 (.mp4, .avi)	MPEG-4 (SP,ASP)	MP3, AAC-LC (2ch)
H.264/MPEG-4 AVC (.mp4, mkv, avi, .flv, .f4v)	H.264/MPG-4 AVC (BP/MP/HP)	MP3, AAC (2ch)
MKV (.mkv)	Video Format follows H.264/MPEG-4 AVC, MPEG4, XVID	MP3, AAC, Vorbis, FLAC

## Specificaties

### Bluetooth-gedeelte

#### Frequentie

: 2,4 – 2,48 GHz

#### RF Output Power (E.I.R.P.)

: +8dBm (MAX)

### Audiogedeelte

#### Luidsprekerimpedantie

: 4 – 8 Ω

### Algemeen

#### Bedrijfsvoeding

: 12V gelijkstroom autoaccu

### Auteursrechten

- Het Bluetooth®-woordmerk en de Bluetooth-logo's zijn het eigendom van Bluetooth SIG, Inc. en elk gebruik van dergelijke merken door JVCKENWOOD Corporation vindt plaats onder licentie. Andere handelsmerken en handelsnamen zijn het eigendom van hun respectievelijke houders.
- Use of the Made for Apple badge means that an accessory has been designed to connect specifically to the Apple product(s) identified in the badge, and has been certified by the developer to meet Apple performance standards. Apple is not responsible for the operation of this device or its compliance with safety and regulatory standards. Please note that the use of this accessory with an Apple product may affect wireless performance.
- Apple, iPhone and Lightning are trademarks of Apple Inc., registered in the U.S. and other countries.
- Android is a trademark of Google LLC.
- Microsoft and Windows Media are either registered trademarks or trademarks of Microsoft Corporation in the United States and/or other countries.
- THIS PRODUCT IS LICENSED UNDER THE MPEG-4 VISUAL PATENT PORTFOLIO LICENSE FOR THE PERSONAL AND NON-COMMERCIAL USE OF A CONSUMER FOR (i) ENCODING VIDEO IN COMPLIANCE WITH THE MPEG-4 VISUAL STANDARD ("MPEG-4 VIDEO") AND/OR (ii) DECODING MPEG-4 VIDEO THAT WAS ENCODED BY A CONSUMER ENGAGED IN A PERSONAL AND NON-COMMERCIAL ACTIVITY AND/OR WAS OBTAINED FROM A VIDEO PROVIDER LICENSED BY MPEG LA TO PROVIDE MPEG-4 VIDEO. NO LICENSE IS GRANTED OR SHALL BE IMPLIED FOR ANY OTHER USE. ADDITIONAL INFORMATION INCLUDING THAT RELATING TO PROMOTIONAL, INTERNAL AND COMMERCIAL USES AND LICENSING MAY BE OBTAINED FROM MPEG LA, LLC. SEE [HTTP://WWW.MPEGLA.COM](http://WWW.MPEGLA.COM).
- THIS PRODUCT IS LICENSED UNDER THE AVC PATENT PORTFOLIO LICENSE FOR THE PERSONAL USE OF A CONSUMER OR OTHER USES IN WHICH IT DOES NOT RECEIVE REMUNERATION TO (i) ENCODE VIDEO IN COMPLIANCE WITH THE AVC STANDARD ("AVC VIDEO") AND/OR (ii) DECODE AVC VIDEO THAT WAS ENCODED BY A CONSUMER ENGAGED IN A PERSONAL ACTIVITY AND/OR WAS OBTAINED FROM A VIDEO PROVIDER LICENSED TO PROVIDE AVC VIDEO. NO LICENSE IS GRANTED OR SHALL BE IMPLIED FOR ANY OTHER USE. ADDITIONAL INFORMATION MAY BE OBTAINED FROM MPEG LA, L.L.C. SEE [HTTP://WWW.MPEGLA.COM](http://WWW.MPEGLA.COM)
- libFLAC  
Copyright (C) 2000-2009 Josh Coalson  
Copyright (C) 2011-2013 Xiph.Org Foundation
  - Redistribution and use in source and binary forms, with or without modification, are permitted provided that the following conditions are met:
  - Redistributions of source code must retain the above copyright notice, this list of conditions and the following disclaimer.

– Redistributions in binary form must reproduce the above copyright notice, this list of conditions and the following disclaimer in the documentation and/or other materials provided with the distribution.

Neither the name of the Xiph.org Foundation nor the names of its contributors may be used to endorse or promote products derived from this software without specific prior written permission.

THIS SOFTWARE IS PROVIDED BY THE COPYRIGHT HOLDERS AND CONTRIBUTORS "AS IS" AND ANY EXPRESS OR IMPLIED WARRANTIES, INCLUDING, BUT NOT LIMITED TO, THE IMPLIED WARRANTIES OF MERCHANTABILITY AND FITNESS FOR A PARTICULAR PURPOSE ARE DISCLAIMED. IN NO EVENT SHALL THE FOUNDATION OR CONTRIBUTORS BE LIABLE FOR ANY DIRECT, INDIRECT, INCIDENTAL, SPECIAL, EXEMPLARY, OR CONSEQUENTIAL DAMAGES (INCLUDING, BUT NOT LIMITED TO, PROCUREMENT OF SUBSTITUTE GOODS OR SERVICES; LOSS OF USE, DATA, OR PROFITS; OR BUSINESS INTERRUPTION) HOWEVER CAUSED AND ON ANY THEORY OF LIABILITY, WHETHER IN CONTRACT, STRICT LIABILITY, OR TORT (INCLUDING NEGLIGENCE OR OTHERWISE) ARISING IN ANY WAY OUT OF THE USE OF THIS SOFTWARE, EVEN IF ADVISED OF THE POSSIBILITY OF SUCH DAMAGE.

#### • libogg

Copyright (c) 2002, Xiph.org Foundation Redistribution and use in source and binary forms, with or without modification, are permitted provided that the following conditions are met:

- Redistributions of source code must retain the above copyright notice, this list of conditions and the following disclaimer.
- Redistributions in binary form must reproduce the above copyright notice, this list of conditions and the following disclaimer in the documentation and/or other materials provided with the distribution.
- Neither the name of the Xiph.org Foundation nor the names of its contributors may be used to endorse or promote products derived from this software without specific prior written permission.

THIS SOFTWARE IS PROVIDED BY THE COPYRIGHT HOLDERS AND CONTRIBUTORS "AS IS" AND ANY EXPRESS OR IMPLIED WARRANTIES, INCLUDING, BUT NOT LIMITED TO, THE IMPLIED WARRANTIES OF MERCHANTABILITY AND FITNESS FOR A PARTICULAR PURPOSE ARE DISCLAIMED. IN NO EVENT SHALL THE FOUNDATION OR CONTRIBUTORS BE LIABLE FOR ANY DIRECT, INDIRECT, INCIDENTAL, SPECIAL, EXEMPLARY, OR CONSEQUENTIAL DAMAGES (INCLUDING, BUT NOT LIMITED TO, PROCUREMENT OF SUBSTITUTE GOODS OR SERVICES; LOSS OF USE, DATA, OR PROFITS; OR BUSINESS INTERRUPTION) HOWEVER CAUSED AND ON ANY THEORY OF LIABILITY, WHETHER IN CONTRACT, STRICT LIABILITY, OR TORT (INCLUDING NEGLIGENCE OR OTHERWISE) ARISING IN ANY WAY OUT OF THE USE OF THIS SOFTWARE, EVEN IF ADVISED OF THE POSSIBILITY OF SUCH DAMAGE.

# Indice

Prima dell'uso.....	104
Come utilizzare questo manuale.....	104
Precauzioni.....	104
Per iniziare.....	105
Impostazioni orologio.....	105
Di base.....	106
Funzioni dei pulsanti sul pannello frontale.....	106
Operazioni comuni.....	106
Schermata HOME.....	106
Schermata di controllo della sorgente.....	106
Radio digitale.....	107
Funzionamento di base della radio digitale.....	107
Configurazione Radio digitale.....	107
Tuner.....	108
Funzioni di base della tuner.....	108
Stazioni di preselezione.....	108
Impostazione radio.....	108
USB.....	109
Preparazione.....	109
Operazioni di riproduzione.....	109
iPhone.....	110
Preparazione.....	110
Operazioni di riproduzione.....	110
Componenti esterni.....	111
Utilizzo di lettori audio/video esterni.....	111
Telecamera a retrovisione.....	111
Funzione di apprendimento del telecomando di sterzo.....	111
Inversione con ATT.....	112
Bluetooth.....	112
Registrazione il proprio smartphone sull'unità.....	112
Ricevere una telefonata.....	112
Effettuare una telefonata.....	112
Riproduzione del dispositivo audio Bluetooth.....	113
Regolazione audio.....	113
Regolazione generale dell'audio.....	113
Installazione.....	114
Prima dell'installazione.....	114
Installazione dell'unità.....	115
Informazioni su questa unità.....	119
Ulteriori informazioni.....	119
Specifiche.....	119
Copyright.....	120

- Per le operazioni e le informazioni dettagliate, fare riferimento al MANUALE DI ISTRUZIONI disponibile sul seguente sito web:  
<<https://www.jvc.net/cs/car/>>.



# Prima dell'uso

## Come utilizzare questo manuale

- Le immagini dei pannelli riportate in questa guida sono esempi utilizzati per spiegare in modo chiaro il funzionamento. Per questo motivo, possono differire dagli effettivi pannelli.
- Nelle procedure operative, il tipo di parentesi indica il tasto o il pulsante da azionare.  
< >: Indica il nome dei pulsanti del pannello.  
[ ]: Indica i nomi dei tasti a sfioramento.



Questo simbolo sul prodotto significa che ci sono importanti istruzioni per l'uso e la manutenzione in questo manuale. Leggere attentamente le istruzioni contenute in questo manuale.

## Precauzioni

### ▲ AVVERTENZA

#### ■ Per prevenire lesioni o incendi, adottare le seguenti precauzioni:

- Per prevenire cortocircuiti, non mettere né lasciare mai oggetti metallici (quali monete o attrezzi di metallo) all'interno dell'unità.
- Non fissare a lungo il display dell'unità durante la guida.
- Se si verificano problemi durante l'installazione, consultare il rivenditore JVC.

#### ■ Precauzioni per l'uso di questa unità

- Prima di acquistare accessori opzionali, verificare con il rivenditore JVC che siano compatibili con il proprio modello e che siano utilizzabili nel proprio Paese.
- È possibile selezionare una lingua per visualizzare menu, tag file audio, ecc. Vedere **Per iniziare (P.105)**
- Le funzioni Radio Data System o Radio Broadcast Data System non funzionano se tale servizio non è fornito dalle emittenti.

#### ■ Protezione del monitor

- Per evitare che il monitor si danneggi, non toccarlo con una penna a sfera o oggetti simili appuntiti.

#### ■ Pulizia dell'unità

Se il frontalino di questa unità è macchiato, pulirlo con un panno morbido asciutto come ad esempio un panno al silicone. Se il frontalino è molto macchiato, rimuovere la macchia con un panno imbevuto di un detergente neutro, quindi ripulirlo con un panno morbido pulito e asciutto.

### ▲ ATTENZIONE

- Applicare detersivi spray direttamente sull'unità può danneggiare i componenti meccanici. Pulendo il frontalino con un panno non morbido o usando un liquido volatile come diluente o alcol si rischia di graffiare la superficie o di cancellare le serigrafie.

#### ■ Reset dell'unità

Se l'unità o l'unità collegata non funziona correttamente, eseguirne il ripristino.



Pulsante di ripristino



# Per iniziare

## 1 Ruotare la chiave di accensione dell'automobile in posizione ACC.

L'unità è accesa, leggere l'avviso e premere "Agree" per accedere allo schermo.



## 2 Premere il tasto < 🏠 >.

## 3 Sfiurare [Settings].

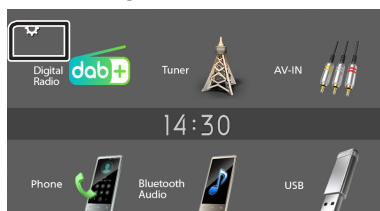

## 4 Sfiurare il tasto corrispondente e impostare il valore.

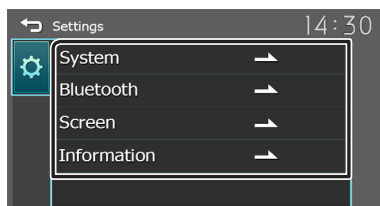

### [System]

#### [Beep Tone]

Attiva o disattiva il tono tastiera. "ON" (Predefinito), "OFF"

#### [Language]

Seleziona la lingua utilizzata per la schermata di controllo e le voci di impostazione. La lingua predefinita è "English" (Inglese).

#### [Time/Date]

Regolare l'orologio. (P.105)

#### [Clock Mode]

Selezionare il formato di visualizzazione dell'ora. [12hr]/[24hr] (Predefinito)

#### [Steering Remote]

Imposta la funzione desiderata nel telecomando dello sterzo. Vedi **Funzione di apprendimento del telecomando di sterzo (P.111)**

#### [Parking Guidelines]

È possibile visualizzare le linee guida per il parcheggio per facilitare il parcheggio quando si innesta la retromarcia (R). L'impostazione predefinita è "ON".

### [Guidelines SETUP]

Se si seleziona [ON] per [Parking Guidelines], è possibile regolare le linee guida per il parcheggio.

### [Reverse with ATT (-20dB)]

Quando la marcia viene spostata in posizione di retromarcia (R), il volume del dispositivo viene regolato. Il default è "ON". Vedi **Come regolare il Reverse con ATT (P.111)**

### [System Reset]

Toccare [System Reset] e quindi toccare [YES] per riportare tutte le impostazioni alle impostazioni iniziali predefinite.

### [Bluetooth]

Viene visualizzata la schermata Impostazioni Bluetooth. (P.112).

### [Screen]

#### [Dimmer]

Selezionare la modalità di attenuazione. "High" (predefinito)"/"Mid"/"Low"

#### [Demo]

Selezionare la modalità dimostrazione. L'impostazione predefinita è "ON".

### [Information]

Visualizza la versione del software e il numero di modello di questa unità.

## 5 Sfiurare [↵].

## Impostazioni orologio

### ☑ Sincronizzazione dell'orologio con FM RDS

Attivare [RDS Clock Sync].

Vedere **Impostazione tuner (P.108)**.

### ☑ Regolazione manuale dell'orologio

📎 NOTA

• Disattivare [RDS Clock Sync] prima di regolare l'orologio.

## 1 Premere il tasto < 🏠 > .

## 2 Sfiurare [Settings].

## 3 Sfiurare [System].

## 4 Sfiurare [Time/Date].

Compare la schermata Orologio.

## 5 Toccare [▲] o [▼] per impostare l'orologio.

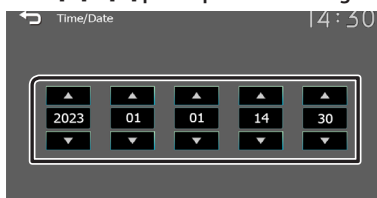

## 6 Sfiurare [↵].

# Di base

## Funzioni dei pulsanti sul pannello frontale

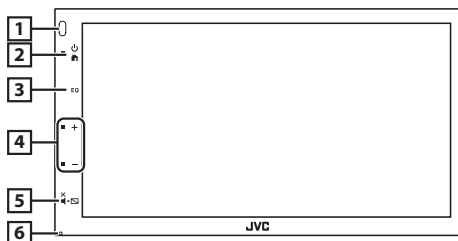

### 1 Sensore remoto

- Riceve il segnale del telecomando.

### 2 (HOME)

- Viene visualizzata la schermata HOME. **(P.106)**
- Tenere premuto il secondo spegne l'alimentazione.
- Se l'alimentazione è disinserita, la inserisce.

### 3 EQ

- Visualizza la schermata Audio.\* **(P.113)**
- \* La schermata Audio non è visualizzata durante la schermata di CONFIGURAZIONE o nella schermata dell'elenco, ecc.

### 4 +, - (Volume)

- Regola il volume. Il volume aumenta fino a 15 quando si tiene premuto [+].

### 5 (MUTE, Display off) (display spento)

- Tacita/ripristina il suono.
- Tenere premuto lo schermo spento. Quando lo schermo è spento, toccare il display per accenderlo.

### 6 Ripristino

- Se l'unità o l'unità collegata non funzionano correttamente, premendo questo pulsante l'unità ritorna alle impostazioni predefinite.

## Operazioni comuni

### Accensione

- 1 Premere il tasto .



### Spegnimento

- 1 Premere e tenere premuto il pulsante .

## Schermata HOME

- 1 Premere il tasto .



Compare la schermata HOME.



- 1 Display orologio

- 2 Passa alla trasmissione radio digitale.\* **(P.107)**  
\* Solo KW-M180DBT

- 3 Passa alla trasmissione tuner. **(P.108)**

- 4 Passa a un componente esterno connesso al terminale di ingresso AV-IN. **(P.111)**

- 5 Visualizza la schermata Vivavoce. **(P.112)**

- 6 Riproduce i contenuti di un lettore audio Bluetooth. **(P.113)**

- 7 [USB] 

Riproduce i file su un dispositivo USB. **(P.109)**

- [iPhone] 

Riproduce un iPhone. **(P.110)**

- Quando un iPhone è connesso.

- [Mirroring] 

Visualizza la schermata Mirroring.

- Quando è collegato un dispositivo Android con l'applicazione "Mirroring OB for JVC" installata.

- 8 Viene visualizzata la schermata IMPOSTAZIONE. **(P.105)**

## Schermata di controllo della sorgente



- 1 : ritorna alla schermata precedente.

- : visualizza la schermata Audio. **(P.113)**

# Radio digitale (KW-M180DBT)

## Funzionamento di base della radio digitale

- 1 Premere il tasto <img alt="Home icon" data-bbox="235 125 265 145"/>.
- 2 Toccare [Digital Radio].

### ■ Schermata di controllo della sorgente

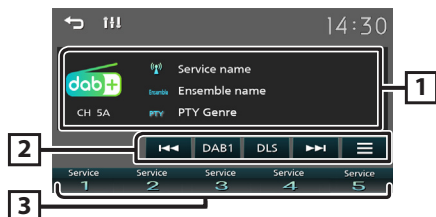

- 1 Vengono visualizzate le informazioni sul servizio corrente:  
nome del servizio, nome gruppo, genere PTY, canale
- 2 **[DAB]**: commuta la banda di preselezione della radio digitale.  
"DAB1", "DAB2", "DAB3"  
**[DLS]**: visualizzare la schermata Segmento etichetta dinamica  
**[<img alt="Left arrow" data-bbox="95 495 115 515"/> <img alt="Right arrow" data-bbox="135 495 155 515"/>]**: selezionare un gruppo, un servizio e un componente.  
**[<img alt="Menu icon" data-bbox="105 525 125 545"/>]**: visualizza la schermata Configurazione radio digitale (**P.107**)
- 3 Richiama l'etichetta servizio memorizzata.  
Se toccato per 2 secondi, archivia il servizio attualmente in ricezione nella memoria.

### ■ Memorizzare un servizio

È possibile memorizzare il servizio di ricezione corrente nella memoria.

- 1 Sintonizzarsi su un servizio che si desidera preimpostare.
  - 2 Toccare e tenere premuto [#] (#:1-5) nel quale si desidera memorizzare il servizio.
- Selezionare un servizio memorizzato
- 1 Toccare [#] (#:1-5).

## Configurazione Radio digitale

- 1 Sforare [].
- 2 Impostare ogni voce come segue.

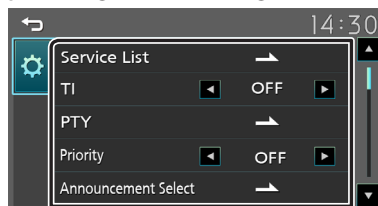

### [Service List]

Visualizza la schermata dell'elenco servizi.

- []: Toccare, quindi toccare [Yes] per trovare l'elenco più recente dei servizi.

### [TI]

Passa automaticamente alle informazioni sul traffico quando inizia la trasmissione di un bollettino sul traffico.

"ON", "OFF" (predefinito)

### [PTY]

Ricerca un programma per tipo di programma.

### [Priority]

Se lo stesso servizio viene fornito anche dalla rete Radio Data System, qualora la ricezione della radio digitale dovesse affievolirsi, questo automaticamente commuta alla funzione Radio Data System.

"ON", "OFF" (predefinito)

### [Announcement Select]

Seleziona il servizio di annunci prescelto.

### [Related Service]

Quando si seleziona ON, l'unità passa a un'etichetta servizio correlata (se presente) quando una rete etichetta servizio DAB non è disponibile. L'impostazione predefinita è "OFF".

### [Antenna Power]

Imposta l'alimentazione di corrente all'antenna della radio digitale. Impostare su "ON" quando l'antenna della radio digitale in uso è dotata di un amplificatore. L'impostazione predefinita è "ON".

- 3 Sforare [].

# Tuner

## Funzioni di base della tuner

- 1 Premere il tast <🏠> button.
- 2 Toccare [Tuner].
- 3 Schermata di controllo della sorgente

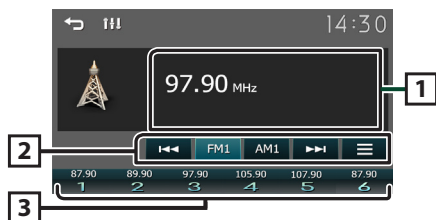

- 1 Visualizza le informazioni della stazione attuale: Nome PS, Frequenza, Genere PTY, Voci di indicazione
- 2 **[FM]** : Cambia la banda FM.  
"FM1", "FM2", "FM3"  
**[AM]** : Cambia la banda AM.  
"AM1", "AM2"  
**[◀▶]** : Consente di sintonizzare automaticamente una stazione con una buona ricezione.  
**[☰]** : visualizza la schermata Configurazione tuner. (**P.108**)
- 3 Richiama la stazione memorizzata.  
Se toccato per 2 secondi, memorizza la stazione attualmente in ricezione nella memoria.

## Stazioni di preselezione

### Memorizzazione automatica

È possibile preimpostare 6 stazioni per la banda corrente (FM1/FM2/FM3/AM1/AM2).

- 1 Toccare **[FM]** o **[AM]** per selezionare la banda.
- 2 Sfiore [☰].
- 3 Toccare **[Auto Store]**.

Le stazioni locali con i segnali più forti vengono individuate e memorizzate automaticamente.

### Memorizzazione manuale

È possibile memorizzare la stazione di ricezione corrente nella memoria.

- 1 Sintonizzarsi su una stazione che si desidera preimpostare.
- 2 Sfiore e tenere premuto **[#]** (#:1-6) nel quale si desidera memorizzare la stazione.

### Richiamo delle stazioni memorizzate

- 1 Toccare **[#]** (#:1-6).

## Impostazione radio

- 1 Sfiore [☰].
- 2 Impostare ogni voce come segue.

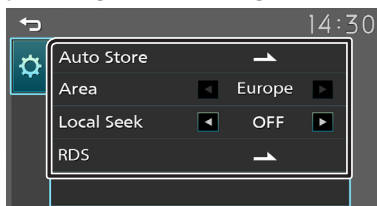

### [Auto Store]

Cerca automaticamente e memorizza le 6 stazioni con il segnale più forte per la banda selezionata. Appare "Auto Store".

### [Area]

"Europe": Intervalli AM/FM: 9 kHz/50 kHz.

### [Local Seek]

Si sintonizza solo sulle stazioni con segnale sufficientemente forte. (L'indicatore **LOC** si accende).  
"ON", "OFF" (predefinito)

### [RDS] \*1

Viene visualizzata la schermata Impostazioni RDS.

### [AF]

Quando il segnale trasmesso dalla stazione è debole, passa automaticamente alla stazione che trasmette lo stesso programma sulla stessa rete Radio Data System.

"ON" (Predefinito), "OFF"

### [TA]

Passa automaticamente alle informazioni sul traffico quando inizia la trasmissione di un bollettino sul traffico. (L'indicatore **TI** si accende).  
"ON", "OFF" (predefinito)

### [RDS Clock Sync]

Sincronizzazione dei dati orario stazione Sistema dati radio e dell'orologio di questa unità.  
"ON" (Predefinito), "OFF"

### [PTY]

Selezionare un tipo di programma.

### [PTY Seek]

Ricerca un programma per tipo di programma.

\*1 Solo FM

- 3 Sfiore [↩].

# USB

## Preparazione

### ■ Connessione di un dispositivo USB

- 1 Togliere il cappuccio al terminale USB.
- 2 Collegare il dispositivo USB con l'apposito cavo.

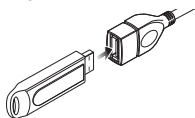

L'unità legge il dispositivo e inizia la riproduzione.

### ■ Per scollegare il dispositivo USB:

- 1 Premere il tasto <img alt="Home button icon" data-bbox="235 291 275 310"/>.
- 2 Toccare una sorgente diversa da [USB].
- 3 Scollegare il dispositivo USB.





### ■ Dispositivi USB utilizzabili

Questa unità può riprodurre file MPEG1/MPEG2/MPEG4/H.264/MKV/MP3/WMA/AAC/WAV/FLAC/OGG memorizzati in un dispositivo di archiviazione di massa USB. (P.119)

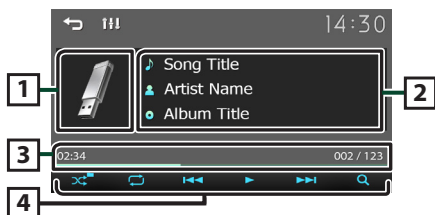
## Operazioni di riproduzione

### ■ Controllare la musica che si sta ascoltando dalla schermata di controllo della sorgente.







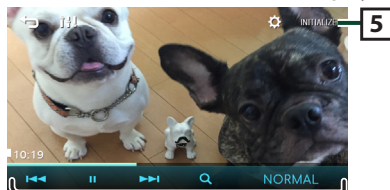

- 1 Viene visualizzata la copertina del file attualmente in riproduzione.
- 2 Vengono visualizzate le informazioni sul file corrente.  
Song Title  
Artist Name  
Album Title
- 3 Tempo di riproduzione/Numero file  
Barra del tempo di riproduzione: per confermare la posizione di riproduzione corrente.
- 4 : seleziona la modalità Riproduzione casuale.  
: seleziona la modalità Riproduzione ripetuta.  
: riproduce o mette in pausa.  
: ricerca il contenuto precedente/successivo.  
Sfiorare e mantenere il contatto per avanzare/ tornare indietro velocemente.  
: ricerca il file. (P.109)



### ■ Per la riproduzione video

- 1 Quando i pulsanti funzione non sono visualizzati sullo schermo, toccare il display.





- 5 : è possibile regolare la qualità dell'immagine nella schermata video.  
[INITIALIZE]: per cancellare la regolazione.
- 6 , : riproduce o mette in pausa.  
, : ricerca il contenuto precedente/successivo.  
Sfiorare e mantenere il contatto per avanzare/ tornare indietro velocemente.  
: ricerca il file. (P.109)  
[NORMAL]/[16:9]/[4:3]: selezionare una modalità dello schermo.

### ■ Selezione di un brano da un elenco (ricerca i file)

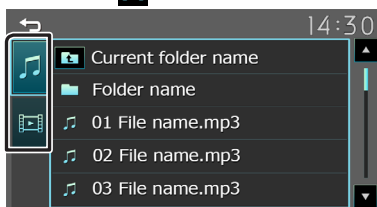
- 1 Sfiocare [Q].
- 2 Selezionare se ricercare per file audio  o per file video .



- 3 Toccare  per spostarsi al livello gerarchico superiore.
- 4 Sfiocare la cartella desiderata.  
Quando si sfiora una cartella, viene visualizzato il relativo contenuto.  
• Toccare  per spostarsi al livello gerarchico superiore.
- 5 Sfiocare la voce desiderata dall'elenco dei contenuti.  
Inizia la riproduzione.

#### 📌 NOTA

- Viene visualizzata la schermata di controllo della sorgente quando si tocca  al livello gerarchico superiore.

## Preparazione

### ■ Connessione di un iPhone

- Per i dettagli sulla connessione di iPhone, vedere a pagina 118.

#### 1 Togliere il cappuccio al terminale USB.

#### 2 Collegare l'iPhone.

L'Unità legge il dispositivo e inizia la riproduzione.

### ■ Per disconnettere l'iPhone

#### 1 Premere il tasto <🏠>.

#### 2 Toccare una sorgente diversa da [iPhone].

#### 3 Scollegare l'iPhone.

### ■ iPhone collegabili

A quest'unità è possibile collegare i seguenti modelli.

Per

- |                              |                     |
|------------------------------|---------------------|
| • iPhone 14 Pro Max          | • iPhone 11 Pro Max |
| • iPhone 14 Pro              | • iPhone 11 Pro     |
| • iPhone 14 Plus             | • iPhone 11         |
| • iPhone 14                  | • iPhone XS Max     |
| • iPhone 13 Pro Max          | • iPhone XS         |
| • iPhone 13 Pro              | • iPhone XR         |
| • iPhone 13                  | • iPhone X          |
| • iPhone 13 mini             | • iPhone 8 Plus     |
| • iPhone 12 Pro Max          | • iPhone 8          |
| • iPhone 12 Pro              | • iPhone 7 Plus     |
| • iPhone 12                  | • iPhone 7          |
| • iPhone 12 mini             | • iPhone SE         |
| • iPhone SE (2nd generation) | • iPhone 6s Plus    |
|                              | • iPhone 6s         |

#### ✎ NOTA

- Se si avvia la riproduzione dopo aver collegato l'iPhone, viene riprodotta prima la musica che è stata riprodotta dall'iPhone.
- Mettere sempre il cappuccio al terminale USB quando non è in uso.

## Operazioni di riproduzione

### ■ Controllare la musica che si sta ascoltando dalla schermata di controllo della sorgente.

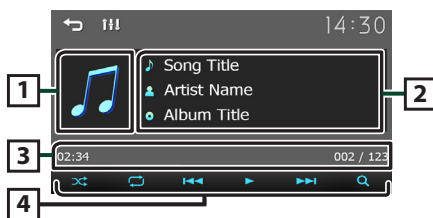

- 1 Copertina (mostrata se il brano contiene una copertina)
- 2 Vengono visualizzate le informazioni sul file corrente.
- 3 Tempo di riproduzione/Numero file  
**Barra del tempo di riproduzione** : per confermare la posizione di riproduzione corrente.
- 4 [⏮] : seleziona la modalità Riproduzione casuale.  
[🔄] : seleziona la modalità Riproduzione ripetuta.  
[▶], [⏸] : riproduce o mette in pausa.  
[⏪], [⏩] : ricerca il contenuto precedente/successivo.  
Sfiorare e mantenere il contatto per avanzare/tornare indietro velocemente.  
[🔍] : ricerca i contenuti. **(P.110)**

### ■ Selezione di un contenuto in un elenco

#### 1 Sfiocare [ Q ].

#### 2 Sfiocare la voce desiderata.

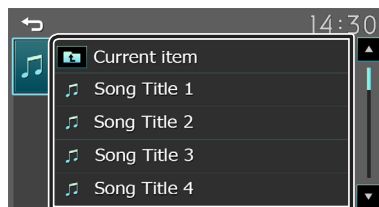

Quando si tocca una categoria, viene visualizzato il relativo contenuto.

#### 3 Sfiocare la voce desiderata dall'elenco dei contenuti.

Inizia la riproduzione.

- Toccare [↵] per spostarsi al livello gerarchico superiore.

#### ✎ NOTA

- Viene visualizzata la schermata di controllo della sorgente quando si tocca [↵] al livello gerarchico superiore.

# Componenti esterni

## Utilizzo di lettori audio/video esterni

### ■ Inizio della riproduzione

- 1 Connettere un componente esterno al terminale di ingresso AV-IN. (P.117)
- 2 Premere il tasto <🏠>.
- 3 Toccare [AV-IN].
- 4 Accendere il componente collegato e avviare la riproduzione della sorgente.

### ■ Per la riproduzione video

- 1 Quando i pulsanti funzione non sono visualizzati sullo schermo, toccare il display.

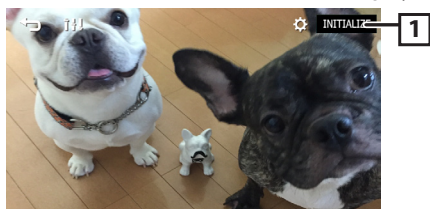

- 1 [⚙️] : è possibile regolare la qualità dell'immagine nella schermata video.  
[INITIALIZE] : per cancellare la regolazione.

### 📎 NOTA

- Quando l'immagine dalla telecamera a retrovisione è visualizzata sulla schermata AV-IN, l'uscita dell'immagine dal terminale di uscita video scompare.

## Telecamera a retrovisione

Per utilizzare una telecamera a retrovisione, è necessaria una connessione del cavo REVERSE. Per collegare una telecamera a retrovisione. (P.117)

### ■ Visualizzazione dell'immagine dalla telecamera a retrovisione

La schermata a retrovisione viene visualizzata quando si innesta la retromarcia (R).



- Il primo tocco rimuove l'attenzione e il secondo tocco chiude lo schermo della fotocamera

## Funzione di apprendimento del telecomando di sterzo

Questa funzione è disponibile solo quando il veicolo è dotato del telecomando elettrico dello sterzo.

- 1 Premere il tasto <🏠>.
- 2 Sfiocare [Settings].
- 3 Toccare [System].
- 4 Toccare [Steering Remote].
- 5 Toccare la funzione che si desidera impostare.
- 6 Tenere premuto il pulsante del telecomando dello sterzo.

### 📎 NOTA

- Puoi far imparare all'unità tutti i pulsanti alla volta. In tal caso, premere tutti i pulsanti uno alla volta e dopo averli premuti tutti, toccare [↵] nella schermata di impostazione del telecomando Steering.

- 7 Ripetere i passaggi 5 e 6 se necessario.

- 8 Toccare [↵].

### 📎 NOTA

- Toccare [Initialize] e quindi toccare [Yes] per impostare tutti i simboli sulla loro posizione iniziale predefinita.

## Inversione con ATT (-20dB)

Quando la marcia viene spostata in posizione di retromarcia (R), il volume del dispositivo viene regolato.

- 1 Premere il tasto <🏠>.
- 2 Sfiocare [Settings].
- 3 Toccare [System].
- 4 Toccare [Reverse with ATT].
- 5 Toccare [◀] or [▶] impostato su [ON]/[OFF].

### 📎 NOTA

- Il valore di impostazione è ON (predefinito).

# Bluetooth

## Registrare il proprio smartphone sull'unità.

È possibile utilizzare il proprio smartphone Bluetooth se è abbinato a quest'unità.

**1 Attivare la funzione Bluetooth sul proprio smartphone/telefono cellulare.**

**2 Ricerare l'unità ("KW-M180DBT"/"KW-M180BT") dal proprio smartphone o cellulare.**

Se viene richiesto un codice PIN, immettere il codice PIN ("0000").

-  compare quando è connesso lo smartphone dotato di Bluetooth.

### **Disconnessione del dispositivo**

- Disattivare la funzione Bluetooth sul proprio smartphone/telefono cellulare.
- Spegnere l'interruttore di accensione.

## Ricevere una telefonata

**1 Sfiore [📞].**

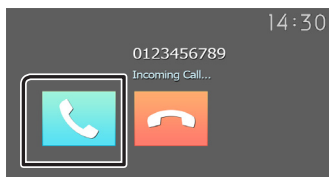

- : Rifiutare una chiamata in arrivo.

### **Operazioni durante una chiamata**

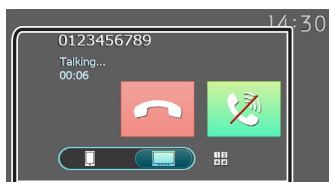

 Terminare una chiamata

 Silenzia la tua voce

 È possibile inviare i toni sfiorando i tasti desiderati sulla schermata.

- Toccare  per chiudere la finestra.

  Commuta l'uscita della voce del parlato tra lo smartphone/telefono cellulare e l'altoparlante.

• **Regolare il volume del ricevitore**

Premere il pulsante <+> o <->.

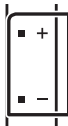

## Effettuare una telefonata



**1 Premere il tasto <🏠>.**

**2 Toccare [Phone].**

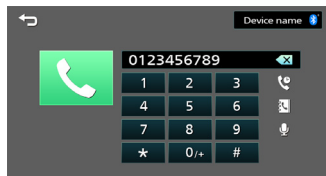



**3 Per ciascuna funzione, fare riferimento alla seguente tabella.**





### **Chiamata tramite inserimento di un numero di telefono**

- 1) Inserire un numero telefonico utilizzando i tasti numerici.
- 2) Sfiore .  
Effettuare una chiamata
- Toccare  per eliminare l'ultimo inserimento.

### **Chiamata utilizzando l'elenco delle chiamate**





- 1) Sfiore .
- 2) Toccare  (Chiamate in entrata),  (Chiamate in uscita),  (Chiamate perse).
- 3) Selezionare il numero telefonico dall'elenco.  
Effettuare una chiamata

### **Chiamata mediante rubrica telefonica**

- 1) Sfiore .
- 2) Selezionare il nome dall'elenco.  
Effettuare una chiamata
- : Consente di aggiornare la rubrica. Toccare questo pulsante dopo aver eseguito una modifica nella rubrica dello smartphone/telefono cellulare.

### **Chiamata in attesa**

Quando ricevi una nuova chiamata mentre parli al telefono:

- 1) Sfiore , la chiamata corrente viene messa in attesa e si può rispondere alla chiamata appena ricevuta
- 2) Ogni volta che si tocca , il chiamante passa all'altro.
- 3) Se si tocca  durante l'attesa di chiamata, rifiutare una chiamata in arrivo.
- 4) Se si tocca , quando qualcuno è in attesa, la chiamata corrente finirà per essere spostata alla chiamata in attesa.
- 5) Sfiore  silenzia la tua voce.



## Bluetooth

### Riproduzione del dispositivo audio Bluetooth

- 1 Premere il tasto <🏠> .
- 2 Toccare [Bluetooth Audio].

#### ☑ Schermata di controllo della sorgente

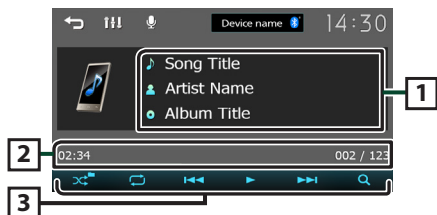

- 1 Vengono visualizzate le informazioni sul file corrente.
- 2 Tempo di riproduzione/Numero file  
**Barra del tempo di riproduzione** : per confermare la posizione di riproduzione corrente.

- 3 [⏮]: seleziona la modalità Riproduzione casuale.  
[🔄]: seleziona la modalità Riproduzione ripetuta.  
[▶], [⏸]: riproduce o mette in pausa.  
[⏪], [⏩]: ricerca il contenuto precedente/ successivo.  
Sfiorare e mantenere il contatto per avanzare/ tornare indietro velocemente.

[Q]: ricerca il file (**P.113**)

#### 📎 NOTA

- Le operazioni e le indicazioni del display possono variare in base alla disponibilità sul dispositivo collegato.

#### ☑ Selezione di un contenuto in un elenco

- 1 Sfioccare [ Q ].
- 2 Sfioccare la voce desiderata.  
Quando si tocca una categoria, viene visualizzato il relativo contenuto.
- 3 Sfioccare la voce desiderata dall'elenco dei contenuti.  
Inizia la riproduzione.

- Toccare [↵] per spostarsi al livello gerarchico superiore.

#### 📎 NOTA

- Viene visualizzata la schermata di controllo della sorgente quando si tocca [↵] al livello gerarchico superiore.

## Regolazione audio

È possibile regolare varie impostazioni, per esempio il bilanciamento audio o il livello del subwoofer.

- 1 Premere il pulsante <EQ>.
- 2 Per ciascuno metodo di funzionamento, fare riferimento a quanto segue.

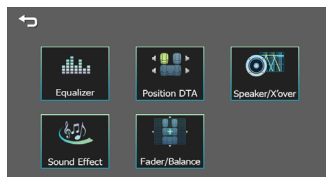

### Regolazione generale dell'audio

- 1 Premere il pulsante <EQ>.
- 2 Sfioccare [Fader / Balance].
- 3 Impostare ogni voce come segue.

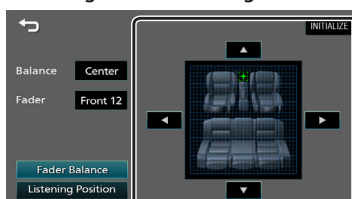

#### [Fader Balance]

**Balance** Regolare il bilanciamento del volume sinistro e destro.

[◀] [▶]  
Da 15 (sinistra) a 15 (destra)

**Fader** Regolare il bilanciamento del volume anteriore e posteriore.

[▲] [▼]  
Da 15 (anteriore) a 15 (posteriore)

[INITIALIZE] Per cancellare la regolazione.

#### [Listening Position]

[●] Selezionare una posizione di ascolto tra "Front Left", "Front All", "Front Right" e "Middle".

[INITIALIZE] Per cancellare la regolazione.

# Installazione

## Prima dell'installazione

Prima dell'installazione di quest'unità, osservare le seguenti precauzioni.

### ▲AVVERTENZE

- Se si collega il cavo di accensione (rosso) e il cavo della batteria (giallo) al telaio della vettura (massa), si potrebbe provocare un cortocircuito, dal quale potrebbe scaturire un incendio. Collegare sempre questi cavi all'alimentazione passante per la scatola fusibili.
- Non escludere il fusibile dal cavo di accensione (rosso) e dal cavo della batteria (giallo). L'alimentazione deve essere collegata ai cavi tramite il fusibile.

### ▲ATTENZIONE

- Installare quest'unità nella console del veicolo. Durante e immediatamente dopo l'uso dell'unità non toccare la parte metallica dell'unità stessa, poiché la temperatura delle parti metalliche, come ad esempio il termodispersore e il contenitore, può diventare molto alta.

### NOTA

- Il montaggio e i collegamenti elettrici di questo prodotto richiedono competenza ed esperienza. Per garantire la massima sicurezza, affidare il montaggio e i collegamenti elettrici a tecnici qualificati.
- Collegare l'unità a massa ad un'alimentazione negativa a 12 V c.c.
- Non installare l'unità in un punto esposto alla luce solare diretta o a calore o umidità eccessivi. Evitare anche luoghi troppo polverosi o esposti a possibili spruzzi d'acqua.
- Non usare viti di tipo diverso; utilizzare soltanto quelle fornite in dotazione. L'uso di viti non idonee, potrebbe danneggiare l'unità.
- Se l'accensione della vettura non prevede la posizione ACC, collegare i cavi dell'accensione ad un'alimentazione commutabile mediante la chiave di accensione. Se si collega il cavo di accensione ad un'alimentazione a tensione costante, come i cavi della batteria, la batteria potrebbe scaricarsi.
- Se la console ha un coperchio, installare l'unità in modo che il frontalino non urti contro il coperchio durante l'apertura e la chiusura.
- In caso di intervento del fusibile, verificare prima se l'eventuale contatto dei cavi ha provocato un cortocircuito e quindi sostituire il fusibile con uno di capacità identica.
- Isolare i cavi scollegati con nastro vinilico o un materiale simile. Per evitare cortocircuiti, non rimuovere i cappucci alle estremità dei cavi

scollegati o dei terminali.

- Assicurare i cavi con dei morsetti e avvolgere del nastro vinilico attorno ai cavi che entrano in contatto con le parti in metallo per proteggerli e per evitare un corto circuito.
- Collegare correttamente i cavi degli altoparlanti ai corrispondenti terminali. L'unità potrebbe danneggiarsi o smettere di funzionare se si condividono i cavi ⊖ o se li si collega a qualsiasi parte metallica nel veicolo.
- Se al sistema sono collegati soltanto due altoparlanti, collegare i connettori ad entrambi i terminali di uscita anteriori o ad entrambi i terminali di uscita posteriori (non collegare contemporaneamente ai terminali anteriori e posteriori). Per esempio, se si collega il connettore ⊕ dell'altoparlante sinistro a un terminale di uscita frontale, non collegare il connettore ⊖ a un terminale di uscita posteriore.
- Dopo l'installazione dell'unità, controllare il corretto funzionamento di luci di arresto, lampeggiatori, tergicristalli, ecc.
- Montare l'unità con un'angolazione non superiore a 30°.
- Non premere con decisione sulla superficie del pannello durante l'installazione dell'unità sul veicolo, onde evitare possibili deformazioni, danni o anomalie.
- La presenza di oggetti metallici in prossimità dell'antenna Bluetooth può compromettere l'efficacia della ricezione.



## Installazione

### Accessori in dotazione per l'installazione

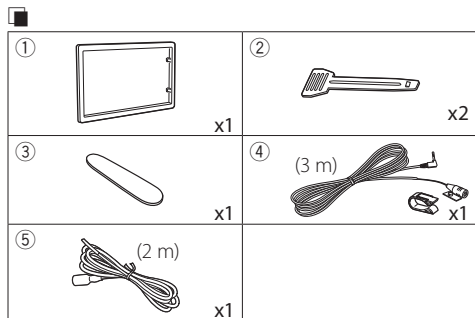

### Procedura di installazione

- 1) Per evitare cortocircuiti, estrarre la chiave dall'accensione e scollegare il  $\ominus$  morsetto della batteria.
- 2) Effettuare le corrette connessioni dei cavi in ingresso e in uscita da ciascuna unità.
- 3) Collegare il cavo al cablaggio.
- 4) Prendere il connettore B dal cablaggio e collegarlo al connettore dell'altoparlante sul veicolo.
- 5) Prendere il connettore A dal cablaggio e collegarlo al connettore dell'alimentazione esterna sul veicolo.
- 6) Collegare il connettore del cablaggio all'unità.
- 7) Installare l'unità sul veicolo.
- 8) Ricollegare il terminale  $\ominus$  della batteria.
- 9) Premere il pulsante di ripristino.

### Installazione dell'unità

#### Autovetture non giapponesi

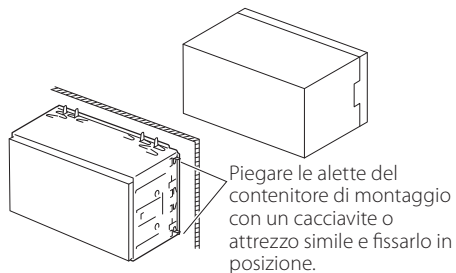

#### NOTA

- Verificare che l'unità sia saldamente installata in posizione. Se l'unità è instabile potrebbe non funzionare correttamente (ad esempio potrebbero verificarsi "salti" in fase di riproduzione).

#### Piastra di taglio

- 1) Fissare l'accessorio ① all'unità.

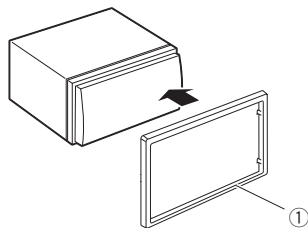

## Installazione

### Microfono

- 1) Controllare la posizione di installazione del microfono (accessorio ④).
- 2) Pulire la superficie di installazione.
- 3) Rimuovere il separatore del microfono (accessorio ④) e attaccare il microfono nel punto mostrato di seguito.
- 4) Collegare il cavo del microfono fino all'unità, fissandolo in vari punti con nastro adesivo o altri metodi di fissaggio.
- 5) Regolare la direzione del microfono (accessorio ④) rispetto al guidatore.

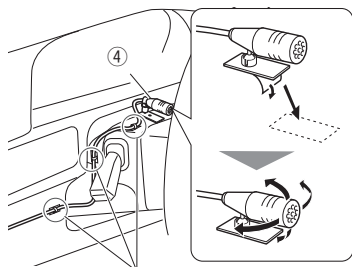

Fissare un cavo con un nastro normalmente reperibile in commercio.

### NOTA

- Invertire i clip se necessario.



### Rimozione della piastra di taglio

- 1) Utilizzare la chiave di estrazione (accessorio ③) per estrarre le quattro linguette (due sulla parte sinistra, due su quella destra).

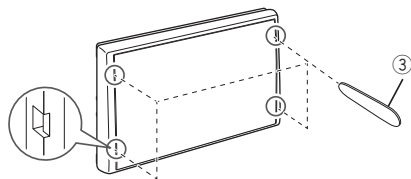

- 2) Tirare la piastra da taglio in avanti.

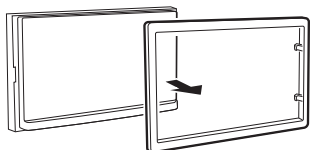

### Rimozione dell'unità

- 1) Rimuovere la piastra di taglio facendo riferimento al passaggio 1 in "Rimozione della piastra di taglio".
- 2) Inserire la chiave di estrazione (accessorio ②) in profondità nella fessura come mostrato in figura. (La sporgenza sulla punta della chiave di estrazione deve trovarsi di fronte all'unità).

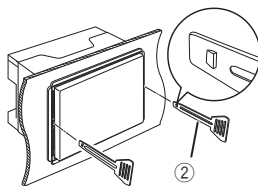

- 3) Con la chiave di estrazione inserita fissata, inserire l'altra chiave di estrazione nella fessura.

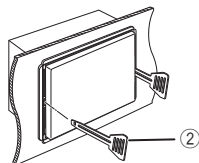

- 4) Estrarre per metà l'unità

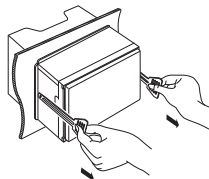

### NOTA

- Fare attenzione a non ferirsi con i dadi di blocco sulla chiave di estrazione.
- 5) Estrarre completamente l'unità senza farla cadere.

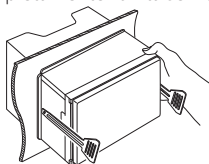

# Installazione

## Collegare i fili ai terminali

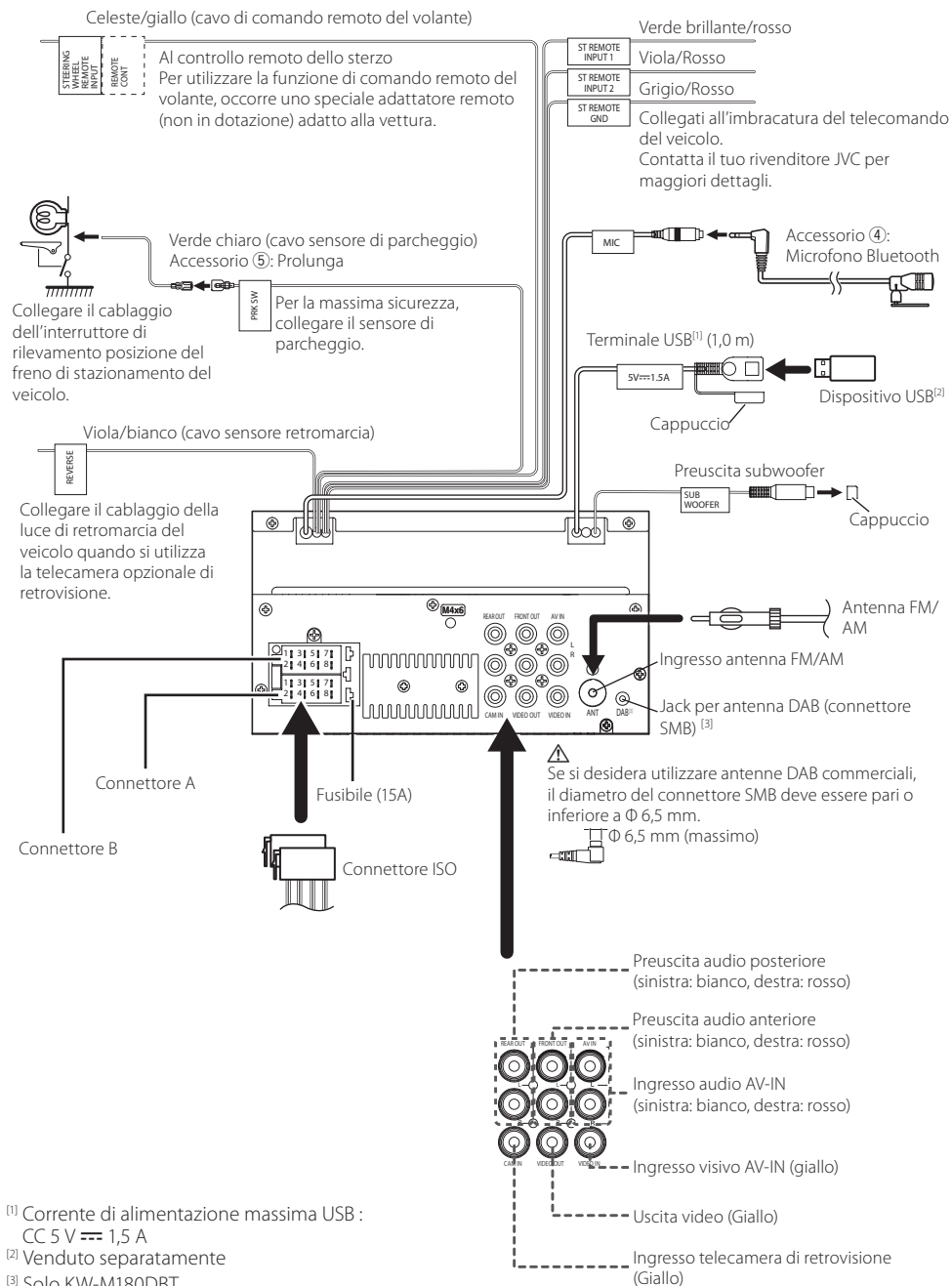

<sup>(1)</sup> Corrente di alimentazione massima USB :  
CC 5 V  $\approx$  1,5 A

<sup>(2)</sup> Venduto separatamente

<sup>(3)</sup> Solo KW-M180DBT

## Installazione

### Guida alle funzioni dei connettori di cablaggio

Contatto	Colori e funzioni	
A-4	Giallo	Batteria
A-5	Blu/Bianco <sup>[1]</sup>	Comando alimentazione
A-7	Rosso	Accensione (ACC)
A-8	Nero	Collegamento a terra (massa)
B-1/B-2	Porpora (+)/viola/nero (-)	Posteriore destro
B-3/B-4	Grigio (+)/grigio/nero (-)	Anteriore destro
B-5/B-6	Bianco (+)/Bianco/Nero (-)	Anteriore sinistro
B-7/B-8	Verde (+) / verde/nero (-)	Posteriore sinistro

<sup>[1]</sup> Max. 150 mA, 12 V

- Impedenza altoparlante: 4-8 Ω

### ⚠ ATTENZIONE

Prima di collegare i connettori ISO disponibili in commercio all'unità, controllare quanto segue:

- Assicurarsi che l'assegnazione del pin del connettore corrisponda all'unità JVC.
- Prestare molta attenzione al cavo di alimentazione.
- Nel caso in cui il cavo della batteria e il cavo di accensione non corrispondano, cambiarli.
- Nel caso in cui la macchina non disponga di un cavo di accensione, utilizzare un'interfaccia disponibile in commercio.

### Connessione di un iPod/iPhone/ dispositivo Android

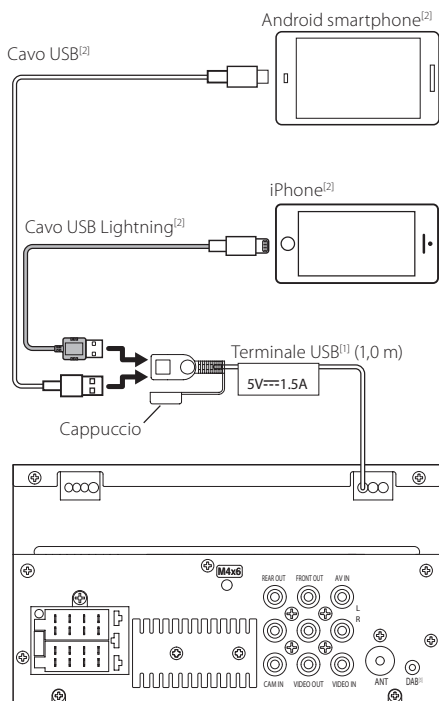

<sup>[1]</sup> Corrente di alimentazione massima USB  
CC 5 V --- 1,5 A

<sup>[2]</sup> Venduto separatamente

<sup>[3]</sup> Solo KW-M180DBT

# Informazioni su questa unità

## Ulteriori informazioni

### Dispositivi USB utilizzabili

Questa unità può riprodurre file MPEG1/MPEG2/MPEG4/H.264/MKV/MP3/WMA/AAC/WAV/FLAC/OGG memorizzati in un dispositivo di archiviazione di massa USB.

- File system: FAT16 / FAT32 / NTFS / exFAT
- Questa unità è in grado di riconoscere un totale di 9.999 file e 320 cartelle (un massimo di 9.999 file per cartella).
- Il numero massimo di caratteri:
  - Nomi cartella: 70 caratteri
  - Nomi file: 70 caratteri
  - Tag: 70 caratteri

### NOTA

- Quando il dispositivo USB è collegato a quest'unità, può essere caricato mediante il cavo USB.
- Installare il dispositivo USB in un punto che non comprometta la sicurezza della guida.
- Non è possibile collegare un dispositivo USB attraverso un hub USB e un lettore multischede.
- Eseguire backup dei file audio usati con questa unità. I file potrebbero essere cancellati a seconda delle condizioni operative del dispositivo USB. Non è previsto nessun risarcimento per i danni derivanti dalla cancellazione dei dati.
- Nessun dispositivo USB è fornito in dotazione con questa unità. Il dispositivo USB deve essere acquistato separatamente.
- Mettere sempre il cappuccio al terminale USB quando non è in uso.

### File audio riproducibili

Formato audio	Velocità di trasferimento/ (Numero bit)	Frequenza di campionamento
MP3 (.mp3)	16 – 320kbps, VBR	16 – 48 kHz
WMA (.wma)	16 – 320kbps	16 – 48 kHz
AAC-LC (.m4a)	16 – 320kbps	16 – 48 kHz
Linear PCM (WAVE) (.wav)	(16/24 bit)	8 – 192 kHz
FLAC (.flac)	(16/24 bit)	8 – 192 kHz
Vorbis (.ogg)	(16/24 bit)	8 – 192 kHz

- Questa unità può visualizzare la versione Tag ID3 1.0/1.1/2.2/2.3/2.4 (per MP3).

### NOTA

- I formati WMA e AAC protetti con sistema DRM non possono essere riprodotti.
- Anche se i file audio sono conformi agli standard elencati sopra, potrebbe essere impossibile riprodurli a seconda del tipo o delle condizioni del supporto o del dispositivo.

### File video accettabili

Formato video	Codec video	Codec audio
MPEG-1 (.mpg, .mpeg)	MPEG-1	MPEG Audio Layer 2
MPEG-2 (.mpg, .mpeg)	MPEG-2	MPEG Audio Layer 2
MPEG-4 (.mp4, .avi)	MPEG-4 (SP,ASP)	MP3, AAC-LC (2ch)
H.264/MPEG-4 AVC (.mp4, .mkv, .avi, .flv, .f4v)	H.264/MPG-4 AVC (BP/MP/HP)	MP3, AAC (2ch)
MKV (.mkv)	Video Format follows H.264/MPEG-4 AVC, MPEG4, XVID	MP3, AAC, Vorbis, FLAC

## Specifiche

### Sezione Bluetooth

#### Frequenza

: 2,4 – 2,48 GHz

#### RF Output Power (E.I.R.P.)

: +8dBm (MAX)

### Sezione audio

#### Impedenza altoparlante

: 4 – 8 Ω

### Gen.

#### Tensione di esercizio

: Batteria auto da 12 V CC

### Copyright

- Il marchio e i loghi Bluetooth® sono marchi di fabbrica registrati di proprietà di Bluetooth SIG, Inc. L'uso di tali marchi da parte di JVCKENWOOD Corporation è soggetto a licenza. Gli altri marchi e nomi commerciali sono di proprietà dei rispettivi proprietari.
- Use of the Made for Apple badge means that an accessory has been designed to connect specifically to the Apple product(s) identified in the badge, and has been certified by the developer to meet Apple performance standards. Apple is not responsible for the operation of this device or its compliance with safety and regulatory standards. Please note that the use of this accessory with an Apple product may affect wireless performance.
- Apple, iPhone and Lightning are trademarks of Apple Inc., registered in the U.S. and other countries.
- Android is a trademark of Google LLC.
- Microsoft and Windows Media are either registered trademarks or trademarks of Microsoft Corporation in the United States and/or other countries.
- THIS PRODUCT IS LICENSED UNDER THE MPEG-4 VISUAL PATENT PORTFOLIO LICENSE FOR THE PERSONAL AND NON-COMMERCIAL USE OF A CONSUMER FOR (i) ENCODING VIDEO IN COMPLIANCE WITH THE MPEG-4 VISUAL STANDARD ("MPEG-4 VIDEO") AND/OR (ii) DECODING MPEG-4 VIDEO THAT WAS ENCODED BY A CONSUMER ENGAGED IN A PERSONAL AND NON-COMMERCIAL ACTIVITY AND/OR WAS OBTAINED FROM A VIDEO PROVIDER LICENSED BY MPEG LA TO PROVIDE MPEG-4 VIDEO. NO LICENSE IS GRANTED OR SHALL BE IMPLIED FOR ANY OTHER USE. ADDITIONAL INFORMATION INCLUDING THAT RELATING TO PROMOTIONAL, INTERNAL AND COMMERCIAL USES AND LICENSING MAY BE OBTAINED FROM MPEG LA, LLC. SEE [HTTP://WWW.MPEGLA.COM](http://www.mpegla.com).
- THIS PRODUCT IS LICENSED UNDER THE AVC PATENT PORTFOLIO LICENSE FOR THE PERSONAL USE OF A CONSUMER OR OTHER USES IN WHICH IT DOES NOT RECEIVE REMUNERATION TO (i) ENCODE VIDEO IN COMPLIANCE WITH THE AVC STANDARD ("AVC VIDEO") AND/OR (ii) DECODE AVC VIDEO THAT WAS ENCODED BY A CONSUMER ENGAGED IN A PERSONAL ACTIVITY AND/OR WAS OBTAINED FROM A VIDEO PROVIDER LICENSED TO PROVIDE AVC VIDEO. NO LICENSE IS GRANTED OR SHALL BE IMPLIED FOR ANY OTHER USE. ADDITIONAL INFORMATION MAY BE OBTAINED FROM MPEG LA, L.L.C. SEE [HTTP://WWW.MPEGLA.COM](http://www.mpegla.com)
- libFLAC  
Copyright (C) 2000-2009 Josh Coalson  
Copyright (C) 2011-2013 Xiph.Org Foundation
  - Redistribution and use in source and binary forms, with or without modification, are permitted provided that the following conditions are met:
  - Redistributions of source code must retain the above copyright notice, this list of conditions and the following disclaimer.
- Redistributions in binary form must reproduce the above copyright notice, this list of conditions and the following disclaimer in the documentation and/or other materials provided with the distribution.  
Neither the name of the Xiph.org Foundation nor the names of its contributors may be used to endorse or promote products derived from this software without specific prior written permission.  
THIS SOFTWARE IS PROVIDED BY THE COPYRIGHT HOLDERS AND CONTRIBUTORS "AS IS" AND ANY EXPRESS OR IMPLIED WARRANTIES, INCLUDING, BUT NOT LIMITED TO, THE IMPLIED WARRANTIES OF MERCHANTABILITY AND FITNESS FOR A PARTICULAR PURPOSE ARE DISCLAIMED. IN NO EVENT SHALL THE FOUNDATION OR CONTRIBUTORS BE LIABLE FOR ANY DIRECT, INDIRECT, INCIDENTAL, SPECIAL, EXEMPLARY, OR CONSEQUENTIAL DAMAGES (INCLUDING, BUT NOT LIMITED TO, PROCUREMENT OF SUBSTITUTE GOODS OR SERVICES; LOSS OF USE, DATA, OR PROFITS; OR BUSINESS INTERRUPTION) HOWEVER CAUSED AND ON ANY THEORY OF LIABILITY, WHETHER IN CONTRACT, STRICT LIABILITY, OR TORT (INCLUDING NEGLIGENCE OR OTHERWISE) ARISING IN ANY WAY OUT OF THE USE OF THIS SOFTWARE, EVEN IF ADVISED OF THE POSSIBILITY OF SUCH DAMAGE.
- libogg  
Copyright (c) 2002, Xiph.org Foundation  
Redistribution and use in source and binary forms, with or without modification, are permitted provided that the following conditions are met:
  - Redistributions of source code must retain the above copyright notice, this list of conditions and the following disclaimer.
  - Redistributions in binary form must reproduce the above copyright notice, this list of conditions and the following disclaimer in the documentation and/or other materials provided with the distribution.
  - Neither the name of the Xiph.org Foundation nor the names of its contributors may be used to endorse or promote products derived from this software without specific prior written permission.THIS SOFTWARE IS PROVIDED BY THE COPYRIGHT HOLDERS AND CONTRIBUTORS "AS IS" AND ANY EXPRESS OR IMPLIED WARRANTIES, INCLUDING, BUT NOT LIMITED TO, THE IMPLIED WARRANTIES OF MERCHANTABILITY AND FITNESS FOR A PARTICULAR PURPOSE ARE DISCLAIMED. IN NO EVENT SHALL THE FOUNDATION OR CONTRIBUTORS BE LIABLE FOR ANY DIRECT, INDIRECT, INCIDENTAL, SPECIAL, EXEMPLARY, OR CONSEQUENTIAL DAMAGES (INCLUDING, BUT NOT LIMITED TO, PROCUREMENT OF SUBSTITUTE GOODS OR SERVICES; LOSS OF USE, DATA, OR PROFITS; OR BUSINESS INTERRUPTION) HOWEVER CAUSED AND ON ANY THEORY OF LIABILITY, WHETHER IN CONTRACT, STRICT LIABILITY, OR TORT (INCLUDING NEGLIGENCE OR OTHERWISE) ARISING IN ANY WAY OUT OF THE USE OF THIS SOFTWARE, EVEN IF ADVISED OF THE POSSIBILITY OF SUCH DAMAGE.



# İçindekiler

Kullanmadan önce.....	121
Kullanım kılavuzun okunması:.....	121
Önlemler.....	121
<b>Başlarken .....</b>	<b>122</b>
Saat ayarları.....	122
<b>Temel Özellikler .....</b>	<b>123</b>
Ön Panel Üzerindeki İşlev Düğmeleri.....	123
Genel İşlemler.....	123
ANA SAYFA ekranı açıklamaları.....	123
Liste ekranı.....	123
<b>Dijital Radyo.....</b>	<b>124</b>
Dijital Radyo Basıl Operasyonu.....	124
Dijital Radyo Kurulumu.....	124
<b>Alıcı .....</b>	<b>125</b>
Tuner Temel İşlemi.....	125
İstasyonları önceden ayarlama.....	125
Tuner Kurulumu.....	125
<b>USB .....</b>	<b>126</b>
Hazırlık.....	126
Çalma işlemleri.....	126
<b>iPhone .....</b>	<b>127</b>
Hazırlık.....	127
Çalma işlemleri.....	127
<b>Diş Bileşenler .....</b>	<b>128</b>
Harici ses/video oynatıcılar kullanma.....	128
Arka görüş kamerası.....	128
Uzaktan kumandanın öğrenme işlevi.....	128
ATT ile geri döndür.....	128
<b>Bluetooth .....</b>	<b>129</b>
Akıllı telefonunuzu üniteye kaydettirin.....	129
Bir telefon araması alın.....	129
Bir telefon araması yapın.....	129
Bluetooth Ses Aygıtını Çalma.....	130
<b>Ses Kontrolü.....</b>	<b>130</b>
Genel Sesin Denetimi.....	130
<b>Kurulum.....</b>	<b>131</b>
Kurulumdan Önce.....	131
Birim kurulumu.....	132
<b>Bu Birim hakkında.....</b>	<b>136</b>
Daha fazla bilgi.....	136
Özellikler.....	136
Telif Hakları.....	137

- Ayrıntılı operasyonlar ve bilgi için, şu sitede INSTRUCTION MANUAL'a refer edin:

<<https://www.jvc.net/cs/car/>>.



# Kullanmadan önce

## Kullanım kılavuzun okunması:

- Bu kılavuzda gösterilen paneller, işlemlerin açık bir şekilde açıklanması için kullanılan örneklerdir. Bu nedenle, gerçek panellerden farklı olabilirler.
- İşlem prosedürlerinde, parantez şekli kontrol etmeyen gereken tuşu veya düğmeyi belirtir.  
< >: panel düğmelerinin adını gösterir.  
[ ]: dokunmatik tuşların adını gösterir



Bu sembol, bu kitapta önemli çalışma ve tutma talimatları var demektir. Bu kitaptaki talimatları dikkatli okumayın.

## Önlemler

### ⚠UYARI

#### ■ Yaralanmayı veya ateşi önlemek için aşağıdaki önlemleri alınız:

- Bir kısa devreyi önlemek için, birimin içine hiçbir zaman metal bir obje (madeni paralar ya da metal aletler gibi) koymayınız veya içinde bırakmayınız.
- Uzun süreli sürüşlerinizde birim ekranını izlemeyin veya gözlerinizi sabitlemeyin.
- Eğer kurulum sırasında problem yaşarsanız, JVC satıcınıza danışın.

#### ■ Bu birimin kullanımı ile ilgili önlemler

- İsteğe bağlı aksesuarlar satın aldıysanız, modelinizle ve bölgenizde çalışıklarından emin olmak için JVC yetkili satıcınıza danışın.
- Menüleri, ses dosya etiketlerini gösterecek bir dili seçebilirsiniz, etc. Bkz. **Başlarken (S.122)**
- Radyo Veri Sistemi veya Radyo Yayın Veri Sistemi özelliği, servisin herhangi bir yayını istasyonu tarafından desteklenmediği durumlarda çalışmaz.

#### ■ Monitörü koruma

- Monitörün hasar görmesini önlemek için monitörü, tükenmez kalem veya ucu keskin olan benzer bir alet kullanarak çalıştırmayın.

#### ■ Üniteyi Temizleme

Ünitenin ön paneli lekelenmişse silikon bez gibi kuru, yumuşak bir bezle silin. Ön yüz kötü bir şekilde lekelenmişse lekeleri nötr temizleyiciyle nemlendirilmiş bir bezle silin ve daha sonra temiz, yumuşak ve kuru bir bezle silin.

#### ⚠DİKKAT

- Sprey temizleyiciyi doğrudan üniteye uygulamak, mekanik parçalarını etkileyebilir. Ön paneli sert bir bezle silme veya tiner veya alkol gibi uçucu bir sıvı kullanarak temizleme yüzeyi çizilebilir veya ekran baskısını silebilir.

#### ■ Ünitenizi sıfırlama

Ünite veya bağlı ünite düzgün çalışmazsa üniteyi sıfırlayın.

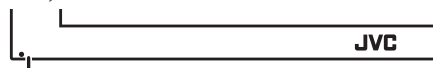

Sıfırlama düğmesi

# Başlarken

## 1 Aracınızın kontak anahtarını ACC konumuna çevirin.

Birim açıldı, lütfen uyarıyı okuyun ve ekranı girmek için "Agree" basın.



## 2 < 🏠 > düğmesine basın.

## 3 [Settings] öğesine dokunun.

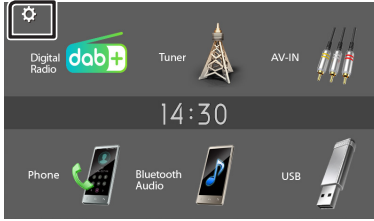

## 4 İlgili tuşa dokunun ve değeri ayarlayın.

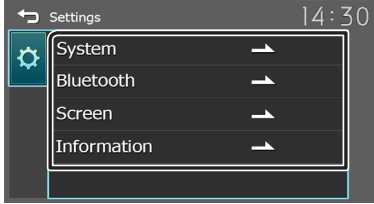

### [System]

#### [Beep Tone]

Tuşa dokunma sesini etkinleştirir veya devre dışı bırakır."ON" (Varsayılan), "OFF"

#### [Language]

Kumanda ekranı ve ayar öğeleri için kullanılan dili seçin. "English" varsayılan ayardır.

#### [Time/Date]

Saati ayarlayın. (S.122)

#### [Clock Mode]

Zamanı görüntüleme biçimini seçin. [12hr] / [24hr] (Varsayılan)

#### [Steering Remote]

İstenen fonksiyonu direksiyon uzaktan kumandasında ayarlar. Bkz. **Uzaktan kumandanın öğrenme işlevi (S.128)**

#### [Parking Guidelines]

Dişliyi ters (R) konuma getirdiğinizde park etmeyi kolaylaştırmak için park etme yönergelerini görüntüleyebilirsiniz. Varsayılan "ON"dur.

### [Guidelines SETUP]

[Parking Guidelines] için [ON] seçerseniz, park etme yönergelerini ayarlayabilirsiniz.

### [Reverse with ATT (-20dB)]

Gerçekçi ters (R) pozisyonuna değiştirildiğinde, cihazın sesi ayarlanır. Öntanımlı "ON". Bkz. **Tersine ATT ile ayarlamak için (S.128)**

### [System Reset]

Tüm ayarları ilk varsayılan ayarlara getirmek için [System Reset] öğesine dokunun ve sonra [YES] öğesine dokunun.

### [Bluetooth]

Bluetooth Ayarlar ekranını görüntüler. (S.129)

### [Screen]

#### [Dimmer]

Işık azaltıcı modunu seçin. "High" (Varsayılan) / "Mid" / "Low"

#### [Demo]

Gösterim modunu seçin. Varsayılan "ON"dur.

### [Information]

Bu birimin yazılım sürümünü ve modeli numarasını gösterir.

## 5 [↔] öğesine dokunun.

## Saat ayarları

### ☑ Saati FM RDS ile senkronize etme

[RDS Clock Sync] öğesini etkinleştirin. Bkz. **Tuner Kurulumu (S.125)**.

### ☑ Saati manuel olarak ayarlama

#### 🔑 NOT

• Saati ayarlamadan önce [RDS Clock Sync] öğesini devre dışı bırakın.

## 1 < 🏠 > düğmesine basın.

## 2 [Settings] öğesine dokunun.

## 3 [System] öğesine dokunun.

## 4 [Time/Date] öğesine dokunun.

Saat ekranı görünür.

## 5 Saati ayarlamak için [▲] veya [▼] öğesine dokunun.

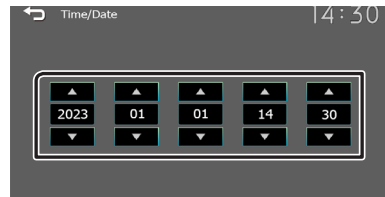

## 6 [↔] öğesine dokunun.

# Temel Özellikler

## Ön Panel Üzerindeki İşlev Düğmeleri

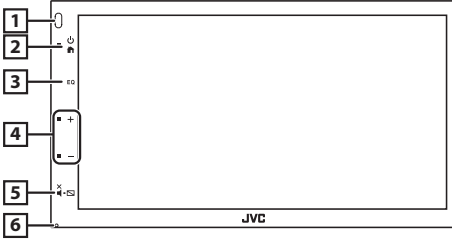

### 1 Uzaktan Algılayıcı

- Uzaktan kumanda sinyalinin alır

### 2 (HOME)

- ANA SAYFA ekranını görüntüler. **(S.123)**
- Basın ve ikinci dakika gücü kapatır.
- Güç kapalı olduğunda gücü açar.

### 3 EQ

- Ses ekranını görüntüler.\* **(S.130)**
- \* Ses ekranı, KURULUM ekranı veya liste ekranında vb. sırasında görüntülenmez,

### 4 +, - (Ses)

- Ses düzeyini ayarlar. [ + ] düğmesine basmaya devam ettiğinizde ses 15'ye kadar devam eder.

### 5 (SESSİZ, Ekran kapalı)

- Sesi kısar/eski haline getirir.
- Basın ve tutun ekranı kapatır.
- Ekranı kapalıyken ekranı açmak için ekrana dokununuz.

### 6 Sıfırla

- Ünite veya bağlı ünite düzgün çalışmazsa, ünite bu düğmeye basıldığında fabrika ayarlarına geri döner.

## Genel İşlemler

### Ünitenin açılması

1 <🏠> düğmesine basın.



### Ünitenin kapatılması

1 <🏠> düğmesini basılı tutun.

## ANA SAYFA ekranı açıklamaları

1 <🏠> düğmesine basın.



ANA SAYFA ekranı görünür.



1 Saat ekranı

Saat ekranını görüntülemek için dokununuz.

2 Basın ve tutun ekranı kapatır. Dijital radyo yayınına geçer.\* **(S.124)**

\* **Yalnızca KW-M180DBT**

3 Tuner yayınına geçer. **(S.125)**

4 AV-IN giriş terminaline bağlı bir harici bileşene geçer. **(S.128)**

5 Eller Serbest Ekranını görüntüler. **(S.129)**

6 Bir Bluetooth ses çalar oynatır. **(S.130)**

7 [USB]

Bir USB cihazındaki dosyaları oynatır. **(S.126)**

[iPhone]

Bir iPhone oynatır. **(S.127)**

• iPhone bağlandığında.

[Mirroring]

Aynalama ekranını görüntüler.

• "Mirroring OB for JVC" uygulamasının yüklü olduğu android cihaz bağlı olduğunda.

8 SETUP ekranını görüntüler. **(S.122)**

## Kaynak kontrol ekranı



1 [🏠]: Önceki ekrana döner.

[☰]: Ses ekranını görüntüler. **(S.130)**

# Dijital Radyo (KW-M180DBT)

## Dijital Radyo Basil Operasyonu

- 1 <img alt="Home button icon" data-bbox="100 108 125 125"/> düğmesine basın.
- 2 [Digital Radio] ögesine dokunun.

### Kaynak kontrol ekranı



- 1 Mevcut hizmetin bilgisini gösterir:  
Servis adı, Ensemble adı, PTY Genre, Kanal
- 2 **[DAB]** : Dijital Radyo ön ayarlama grubunu değiştirir.  
"DAB1", "DAB2", "DAB3"  
**[DLS]** : Dinamik Etiket Bölüm Ekranını Göster  
**[<img alt="Left arrow icon" data-bbox="100 425 125 440"/> <img alt="Right arrow icon" data-bbox="150 425 175 440"/>]** : Bir ensemble, hizmet ve komponent seçin.  
**[<img alt="Menu icon" data-bbox="100 455 125 470"/>]** : Bir ensemble, hizmet ve komponent seçin.  
(S.124)
- 3 Hafızaya alınan istasyonu geri çağırır.  
2 saniye dokunulduğunda, mevcut alıcı istasyonu hafızaya kaydeder.

### Bir hizmet sakla

Ağımdaki alın hizmetini hafızada saklayabilirsiniz.

- 1 Önceden ayarlamak istediğiniz bir hizmete girin
- 2 İstasyonu kaydetmek istediğiniz numaranın simgesine [#] (#:1-5) dokunup basılı tutun.

### Kaydedilen bir hizmet seçin

- 1 [#] (#:1-5) ögesine dokunun.

## Dijital Radyo Kurulumu

- 1 [<img alt="Menu icon" data-bbox="535 108 560 125"/>] düğmesine dokunun.
- 2 Her maddeyi aşağıdaki gibi ayarlayın.

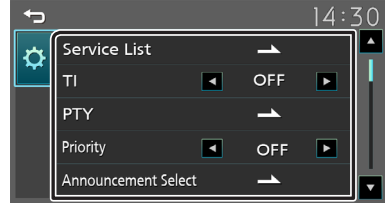

### [Service List]

Servis Listesi ekranını gösterir

- [<img alt="Search icon" data-bbox="535 330 560 345"/>] : Son servis listesini bulmak için dokun ve dokun.

### [TI]

Trafik mermi başladığında trafik bilgisine otomatik olarak değiştirir.

"ON", "off" (Öntanımlı)

### [PTY]

Bir program türü seçin.

### [Priority]

Dijital Radyo tarafından verilen hizmetin alınmasında aynı hizmet Radyo Veri Sistemi tarafından verilirse, otomatik olarak Radyo Veri Sistemine değiştirir.  
"ON", "off" (Öntanımlı)

### [Announcement Select]

Tüm Açıklama Hizmeti'ne geçiyor.

### [Related Service]

Açıklığı seçince, birim DAB hizmet ağı ulaşılmadığında (varsa) ilişkilendirilen bir hizmete değiştirir. Öntanımlı "OFF".

### [Antenna Power]

Dijital Radyo antene'ye güç sağlamlını ayarlar. Kullanıldığı Dijital Radyo anteni bir booster ile hazırlanmış olduğunda "ON" olarak ayarlayın. Öntanımlı "ON".

- 3 [<img alt="Home button icon" data-bbox="535 752 560 769"/>] ögesine dokunun.

# Alıcı

## Tuner Temel İşlemin

- 1 <img alt="Home icon" data-bbox="95 108 125 125"> düğmesine basın.
- 2 [Tuner] ögesine dokununuz.

### Kaynak kontrol ekranı

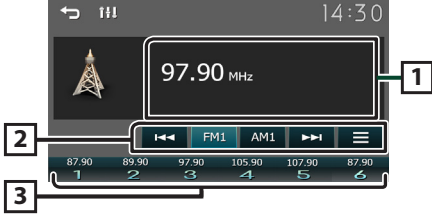

- 1 Geçerli istasyonun bilgilerini görüntüler:  
PS adı, Frekans, PTY Türü, Gösterge Ögeleri
- 2 [FM] : FM bandına geçiş yapar.  
"FM1", "FM2", "FM3"  
[AM] : AM bandına geçiş yapar.  
"AM1", "AM2"  
[<img alt="Left arrow" data-bbox="95 435 125 450"/> <img alt="Right arrow" data-bbox="135 435 165 450"/> ] : Otomatik olarak iyi bir istasyona sahip bir istasyona girer.  
[<img alt="Menu icon" data-bbox="135 465 165 480"/> ] : Ayarlayıcı Ayar ekranını görüntüler. (S.125)
- 3 Hafızaya alınan istasyonu geri çağırır.  
2 saniye dokunulduğunda, mevcut alıcı istasyonu hafızaya kaydeder.

## İstasyonları önceden ayarlama

### Oto hafıza

Mevcut bant (FM1/FM2/FM3/AM1/AM2) için 6 istasyonu önceden ayarlayabilirsiniz.

- 1 Bandı seçmek için [FM] veya [AM] ögesine dokununuz.
- 2 [<img alt="Menu icon" data-bbox="95 685 125 700"/>] ögesine dokununuz.
- 3 [Auto Store] ögesine dokununuz.  
En güçlü sinyallere sahip yerel radyo istasyonları bulunur ve otomatik olarak belleğe kaydedilir.

### Manuel hafıza

Mevcut alıcı istasyonu hafızasında saklayabilirsiniz.

- 1 Ön ayar yapmak istediğiniz bir istasyonu ayarlayın.
- 2 İstasyonu kaydetmek istediğiniz numaranın simgesine [#] (#:1-6) dokunup basılı tutun.

### Ön ayar istasyonunu geri çağırma

- 1 [#] (#:1-6) ögesine dokununuz.

## Tuner Kurulumu

- 1 [<img alt="Menu icon" data-bbox="535 108 565 125"/>] düğmesine dokununuz.
- 2 Her maddeyi aşağıdaki gibi ayarlayın.

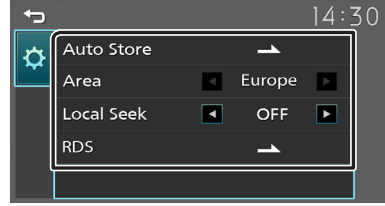

### [Auto Store]

Seçilen bant için en güçlü sinyal seviyesine sahip 6 istasyonu otomatik olarak arayıp kaydeder.  
"Auto Store" görünür.

### [Area]

"Europe" : AM/FM aralıkları: 9 kHz/50 kHz.

### [Local Seek]

Yalnızca yeterli sinyal gücüne sahip istasyonları ayarlar. (LOC göstergesi yanar.)  
"ON", "OFF" (Varsayılan)

### [RDS] \*1

RDS Ayarları ekranını görüntüler.

### [AF]

İstasyon sinyali zayıf olduğunda, aynı Radyo Veri Sistemi ağı üzerinden aynı programı yayınlayan istasyona otomatik olarak geçer.  
"ON", "OFF" (Varsayılan), "OFF"

### [TA]

Trafik bülteni başladığında otomatik olarak trafik bilgilerine geçiş yapar. (TI göstergesi yanar.)  
"ON", "OFF" (Varsayılan)

### [RDS Clock Sync]

Radyo Veri Sistemi istasyon saat verileri ile bu ünitenin saatini senkronize etme.  
"ON", "OFF" (Varsayılan), "OFF"

### [PTY]

Bir program türü seçin.

### [PTY Seek]

Program türüne göre bir program arar.

\*1 Yalnızca FM

- 3 [<img alt="Home icon" data-bbox="535 827 565 844"/>] ögesine dokununuz.

# USB

## Hazırlık

### ■ USB cihaz bağlanması

- 1 USB terminalinin kapağını çıkarın.
- 2 USB cihazını USB kablosu ile bağlayın.

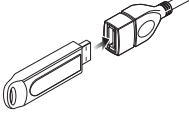

Ünite cihazı okur ve çalma işlemi başlar.

### ■ USB cihazının bağlantısını kesmek için:

- 1 <Home> düğmesine basın.
- 2 [USB] dışında bir kaynağa dokununuz.
- 3 USB cihazını çıkarın.

### ■ Kullanılabilir USB cihazı

Bu ünite bir USB yığın depolama sınıfı cihazında kayıtlı MPEG1/ MPEG2/ MPEG4/ H.264/ MKV/ MP3/ WMA/ AAC/ WAV/ FLAC/ OGG dosyalarını çalabilir. (S.136)

## Çalma işlemleri

### ■ Kaynak kontrolü ekranında dinlediğiniz müziği kontrol edin.

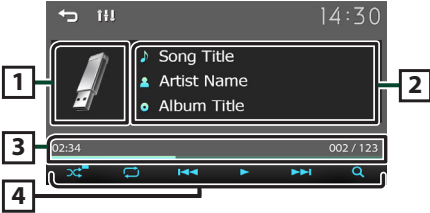

- 1 Çalmakta olan dosyanın ceketi görüntülenir.
- 2 Geçerli dosyanın bilgilerini görüntüler.
- 3 Çalma süresi/Dosya numarası  
Çalma süresi çubuğu : Mevcut çalma konumunun onaylanması için.
- 4 [ ] : Rastgele çalma modunu seçer.  
[ ] : Tekrar çalma modunu seçer.  
[ ] : Çalar veya duraklatır.  
[ ] : Önceki/sonraki içeriği arar.  
Hızlı ileri sarmak veya geriye doğru hızlıca ilerlemek için dokunup basılı tutun.  
[ ] : Dosyayı arar (S.126)

### ■ Video oynatma için

- 1 İşlem düğmeleri ekranda görüntülenmiyorsa ekrana dokununuz.

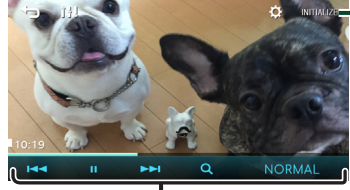

- 5 [ ] : Video ekranında görüntü kalitesini ayarlayabilirsiniz.  
[ ] : Ayarı temizlemek için.
- 6 [ ] : Çalar veya duraklatır.  
[ ] : Önceki/sonraki içeriği arar.  
Hızlı ileri sarmak veya geriye doğru hızlıca ilerlemek için dokunup basılı tutun.  
[ ] : Dosyayı arar. (S.126)  
[ ]/[ ]/[ ] : Bir ekran modu seçin.

### ■ Bir liste içinde bir parçayı seçme (Dosyayı arar)

- 1 [ ] ögesine dokununuz.
- 2 Ses dosyalarının mı [ ] , yoksa video dosyalarının mı [ ] aranacağını seçin.

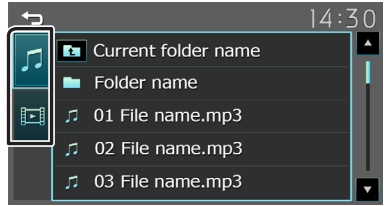

- 3 Üst hiyerarşiye taşımak için [ ] ögesine dokununuz.
  - 4 İsteddiğiniz klasöre dokununuz.  
Bir klasöre dokunduğunuzda içeriği görüntülenir.  
• Üst hiyerarşiye taşımak için [ ] ögesine dokununuz.
  - 5 İçerik listesinden istediğiniz öğeye dokununuz.  
Oynatma başlar.
- NOT
- En üst hiyerarşide [ ] ögesine dokunduğunuzda kaynak kontrol ekranı görünür.

## Hazırlık

### iPhone cihazlarının bağlanması

- iPhone bağlama hakkında daha fazla bilgi için bkz. sayfa 135.

### 1 USB terminalinin kapağını çıkarın.

### 2 iPhone'u bağlayın.

Ünite cihazı okur ve çalma işlemi başlar.

### iPhone'un bağlantısını kesmek için

#### 1 <Home> düğmesine basın.

#### 2 [iPhone] dışında bir kaynağa dokununuz..

#### 3 iPhone'u çıkarın.

### Bağlanabilir iPhone

Aşağıdaki modeller bu üniteye bağlanabilir.

Aşağıdakiler için üretilmiştir:

- iPhone 14 Pro Max
- iPhone 14 Pro
- iPhone 14 Plus
- iPhone 14
- iPhone 13 Pro Max
- iPhone 13 Pro
- iPhone 13
- iPhone 13 mini
- iPhone 12 Pro Max
- iPhone 12 Pro
- iPhone 12
- iPhone 12 mini
- iPhone SE (2nd generation)
- iPhone 11 Pro Max
- iPhone 11 Pro
- iPhone 11
- iPhone XS Max
- iPhone XS
- iPhone XR
- iPhone X
- iPhone 8 Plus
- iPhone 8
- iPhone 7 Plus
- iPhone 7
- iPhone SE
- iPhone 6s Plus
- iPhone 6s

### NOT

- iPhone'u bağladıktan sonra oynatmayı başlatırsanız, önce iPhone tarafından çalınan müzik çalınır.
- Kullanmadığınız her zaman USB terminalinin kapağını kapatın.

## Çalma işlemleri

### Kaynak kontrolü ekranında dinlediğiniz müziği kontrol edin.

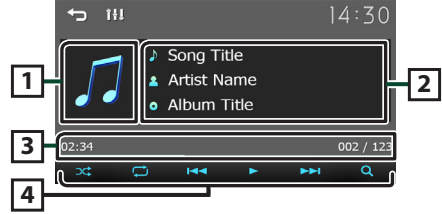

1 Kapak resmi (Parça kapak resmi içeriyorsa gösterilir)

2 Geçerli dosyanın bilgilerini görüntüler.

3 Çalma süresi/Dosya numarası  
Çalma süresi çubuğu : Mevcut çalma konumunun onaylanması için.

4 [ ] : Rastgele çalma modunu seçer.

[ ] : Tekrar çalma modunu seçer.

[▶], [⏸] : Çalar veya duraklatır.

[◀◀], [▶▶] : Önceki/sonraki içeriği arar.

Hızlı ileri sarmak veya geriye doğru hızlıca ilerlemek için dokunup basılı tutun.

[Q] : İçeriği arar. (S.127)

### Bir liste içinde bir içeriği seçme

#### 1 [Q] öğesine dokununuz.

#### 2 İsteddiğiniz öğeye dokununuz.

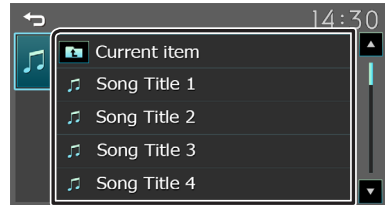

Bir kategoriye dokunduğunuzda içeriği görüntülenir.

#### 3 İçerik listesinden istediğiniz öğeye dokununuz.

Oynatma başlar.

- Üst hiyerarşiye taşımak için [↶] öğesine dokununuz.

### NOT

- En üst hiyerarşide [↶] öğesine dokunduğunuzda kaynak kontrol ekranı görünür.

# Dış Bileşenler

## Harici ses/video oynatıcılar kullanma

### ▶ Oynatmayı başlatma

- 1 AV-IN giriş terminaline harici bir bileşen bağlayın. (S.134)
- 2 <🏠> düğmesine basın.
- 3 [AV-IN] ögesine dokunun.
- 4 Bağlanan bileşeni açın ve kaynağı çalmaya başlayın.

### ▶ Video oynatma için

- 1 İşlem düğmeleri ekranda görüntülenmiyorsa ekrana dokunun.

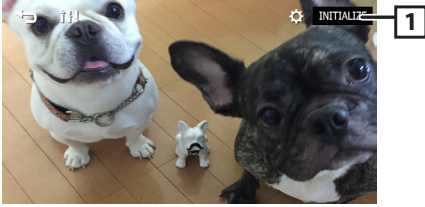

- 1 [⚙️]: Video ekranında görüntü kalitesini ayarlayabilirsiniz.  
[INITIALIZE]: Ayarı temizlemek için.

### 📎 NOT

- AV-IN ekranında arka görüş kamerasından gelen resim görüntülendiğinde, Görsel Çıkış terminalinden gelen görüntü kaybolur.

## Arka görüş kamerası

Bir arka görüş kamerası kullanmak için GERİ ucu bağlantısı gerekir. Bir arka görüş kamerası bağlamak için. (S.134)

### ▶ Arka görüş kamerasından görüntü alınması

Vites geri (R) konuma getirildiğinde arka görünüm ekranı görüntülenir.



- İlk dokunuş Dikkat'ı kaldırır ve ikinci dokunuş kamera Ekranını kapatır.

## Uzaktan kumandanın öğrenme işlevi

Bu işlev yalnızca aracınız, direksiyondan uzaktan kumanda özelliğine sahip ise kullanılabilir.

- 1 <🏠> düğmesine basın.
- 2 [Settings] ögesine dokunun.
- 3 [System] ögesine dokunun.
- 4 [Steering Remote] ögesine dokunun.
- 5 Ayarlamak istediğiniz işleve dokunun.
- 6 Direksiyon uzaktan kumanda düğmesini basılı tutun.

### 📎 NOT

- Ünitenin her seferinde tüm düğmeleri öğrenmesini sağlayabilirsiniz. Bu durumda tüm düğmelere teker teker basın ve hepsine bastıktan sonra Direksiyon Uzaktan Kumanda Ayarı ekranında [↔️] ögesine dokunun.

7 5. ve 6. basamakları gerektiği gibi tekrarlayın.

8 [↔️] ögesine dokunun.

### 📎 NOT

- Tüm ayarları başlangıç varsayılan ayarlara getirmek için [Initialize] ögesine dokunun ve sonra [Yes] ögesine dokunun.

## ATT ile geri döndür (-20dB)

Gerçekçi tersi (R) pozisyonuna değiştirildiğinde, cihazın sesi ayarlanır.

- 1 <🏠> düğmesine basın.
- 2 [Settings] ögesine dokunun.
- 3 [System] ögesine dokunun.
- 4 [Reverse with ATT] ögesine dokunun.
- 5 [◀️] or [▶️] ögesine dokunun.set to [ON]/[OFF].

### 📎 NOT

- Ayarlama değeri açıktır (öntanımlı)



# Bluetooth

## Akıllı telefonunuzu üniteye kaydettirin

Bluetooth akıllı telefonunuzu bu ünite ile eşleştirdiğinizde kullanabilirsiniz.

**1 Akıllı telefonunuzdaki/cep telefonunuzdaki Bluetooth işlevini açın.**

**2 Akıllı telefonunuzdan/cep telefonunuzdan ("KW-M180DBT"/"KW-M180BT") ünitesini aratın.**

- Bir PIN kodu gerekiyorsa PIN kodunu girin ("0000").
- Bluetooth akıllı telefon bağlı olduğunda  görünür.

## ■ Cihazın bağlantısının kesilmesi

- Akıllı telefonunuzdaki/cep telefonunuzdaki Bluetooth işlevini kapatın.
- Kontak anahtarını kapatın.

## Bir telefon araması alın



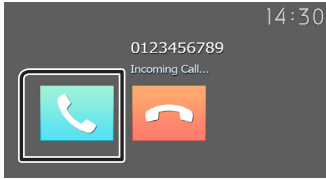

**1  öğesine dokununuz.**

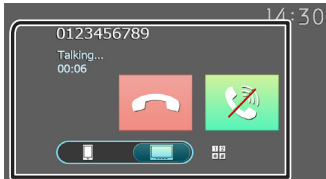

-  : Gelen aramayı reddedin.

## ■ Bir arama sırasında işlemler



-  Bir aramayı sonlandırma
-  Sesini seslendir.
-  Ekrandaki istediğiniz tuşlara dokunarak sesler gönderebilirsiniz.
  - Pencereyi kapatmak için  öğesine dokununuz.
-  Konuşma sesi çıkışı akıllı telefon/cep telefonu ile hoparlör arasında değiştirir.

- Alıcı ses seviyesini ayarlayın  
<-> veya <-> düğmesine basın.

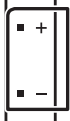



## Bir telefon araması yapın

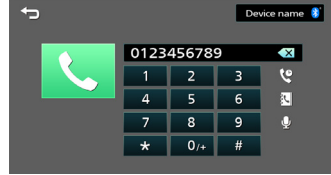



- 1  düğmesine basın.**
- 2 [Phone] üzerine dokununuz.**
- 3 Her çalışma yöntemi için aşağıdaki tabloya bakın.**





## Bir telefon numarası girerek arama

- Sayı tuşlarıyla bir telefon numarası girin.
-  öğesine dokununuz.  
Bir arama yapma
- En son girişi silmek için  öğesine dokununuz.

## Arama kayıtlarını kullanarak arama





-  öğesine dokununuz.
-  (Gelen Aramalar),  (Giden Aramalar),  (Cevapsız Aramalar) öğesine dokununuz.
- Listeden telefon numarasını seçin.  
Bir arama yapma

## Telefon defterini kullanarak arama

-  öğesine dokununuz.
- Listeden adınızı seçin.  
Bir arama yapma
  -  : Telefon defterini günceller. Akıllı telefonunuzun/cep telefonunuzun telefon defterinde bir değişiklik yaptıktan sonra bu düğmeye dokununuz.

## Arama bekliyor

Telefonda konuşurken yeni bir arama alındığında:

-  öğesine dokununuz. şu anda çağrı tutuluyor ve yeni alınan çağrıya cevap verebilirsiniz.
- Her dokunursanız  , çağırıcı diğerine geçicek.
- Arama sırasında  dokunursanız, gelen bir aramayı reddedin.
- Eğer biri tutulurken  dokunursanız, şu anda arama sonunda bekleyen çağrıya çarpılacak.
-  öğesine dokununuz sesini kes.

## Bluetooth

### Bluetooth Ses Aygıtını Çalma

- 1 <🏠> düğmesine basın.
- 2 [Bluetooth Audio] öğesine dokunun..

#### 📱 Kaynak kontrol ekranı

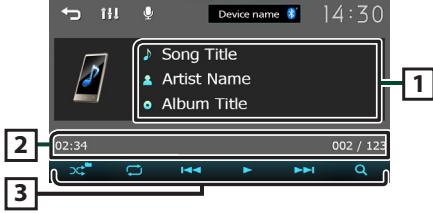

- 1 Geçerli dosyanın bilgilerini görüntüler.
- 2 Çalma süresi/Dosya numarası  
Çalma süresi çubuğu : Mevcut çalma konumunun onaylanması için.

- 3 [🔍] : Rastgele çalma modunu seçer.  
[🔄] : Tekrar çalma modunu seçer.  
[▶], [⏸] : Çalar veya duraklatır.  
[◀], [▶] : Önceki/sonraki içeriği arar.  
Hızlı ileri sarmak veya geriye doğru hızlıca ilerlemek için dokunup basılı tutun.  
[🔍] : Dosyayı arar. (S.130)

#### 📌 NOT

- İşlemler ve ekran göstergeleri bağlı cihazdaki kullanılabilirlik durumuna göre farklılık gösterebilir.

#### 📱 Bir liste içinde bir içeriği seçme

- 1 [🔍] öğesine dokunun.
- 2 İsteddiğiniz öğeye dokunun.  
Bir kategoriye dokunduğunuzda içeriği görüntülenir.
- 3 İçerik listesinden istediğiniz öğeye dokunun.  
Oynatma başlar.
  - Üst hiyerarşiye taşımak için [↶] öğesine dokunun.

#### 📌 NOT

- En üst hiyerarşide [↶] öğesine dokunduğunuzda kaynak kontrol ekranı görünür.

## Ses Kontrolü

Ses dengesi ya da subwoofer seviyesi gibi çeşitli ayarları yapabilirsiniz.

- 1 <EQ> düğmesine basın.
- 2 Her çalıştırma yöntemi için aşağıya bakın.



### Genel Sesin Denetimi

- 1 <EQ> düğmesine basın.
- 2 [Fader / Balance] öğesine dokunun.
- 3 Her maddeyi aşağıdaki gibi ayarlayın.

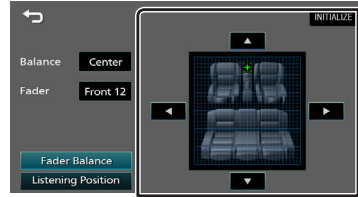

#### [Fader Balance]

**Balance** Sol ve sağ ses dengesini ayarlayın.

[◀] [▶] 15 (sol) ila 15 (sağ)

**Fader** Ön ve arka ses dengesini ayarlayın.

[▲] [▼] 15 (ön) ila 15 (arka)

[INITIALIZE] Ayarı temizlemek için.

#### [Listening Position]

[●] "Front Left", "Front All", "Front Right" ve "Middle" arasından bir dinleme konumu seçin.

[INITIALIZE] Ayarı temizlemek için.

# Kurulum

## Kurulumdan Önce

Üniteyi kurmadan önce lütfen aşağıdaki önlemleri alın.

### ▲ UYARILAR

- Kontak kablosunu (kırmızı) ve akü kablosunu (sarı) otomobilin şasisine (topraklama) bağlarsanız, kısa devreye sebep olabilirsiniz ve bu da yangına sebep olabilir. Bu kabloları güç kaynağına her zaman sigorta kutusu üzerinden bağlayın.
- Kontak kablosu (kırmızı) ile akü kablosu (sarı) hattından sigortayı çıkarmayın. Güç kaynağı kablolarına sigorta üzerinden bağlanmalıdır.

### ▲ DİKKAT

- Bu üniteyi aracınızın konsoluna takın. Birimin kullanımı sırasında veya kısa bir süre sonra bu birimin metal parçasına dokunmayın. Isı alıcı ve muhafaza gibi metal parçaları ısınır.

### NOT



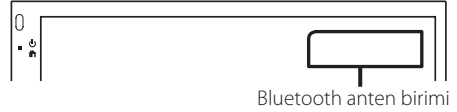

- Bu ürünün montajı ve kablo hattının çekilmesi beceri ve tecrübe gerektirir. En güvenli uygulama için, montaj ve kablo bağlantısı işini uzman kişilere yaptırın.
- Birimi negatif 12V DC güç kaynağına toprakladığınızdan emin olun.
- Üniteyi doğrudan güneş ışığına maruz kalacak bir yere, aşırı sıcak veya nemli ortamlara kurmayın. Fazla toz içeren veya su sıçrama ihtimali bulunan yerlerden de kaçınin.
- Kendi vidalarınızı kullanmayın. Yalnızca ürünle birlikte verilen vidaları kullanın. Yanlış vidaları kullanmanız durumunda birime zarar verebilirsiniz.
- Eğer otomobilinizin kontağı ACC konumuna sahip değilse, kontak anahtarıyla birlikte açılıp kapanabilmesi için kontak kablolarını güç kaynağına bağlayın. Kontak kablosunu, güç kaynağına akü kabloları gibi sürekli elektrik çekeceği şekilde bağlarsanız, akü bitebilir.
- Konsolun bir kapağı varsa, üniteyi, kapatma ve açma sırasında ön panelin kapağı çarpmamasını sağlamaya dikkat edin.
- Sigorta patlarsa, önce kısa devreye neden olacak tellerin temas etmediğinden emin olun, daha sonra eski sigortayı aynı voltaja sahip sigortayla değiştirin.
- Bağlanmayan kabloları vinil bant veya benzer bir malzeme ile yalıtın. Kısa devre olmasını önlemek için bağlanmamış kablo veya terminallerin uçlarında bulunan kapakları çıkarmayın.
- Kabloları kablo kelepçeleriyle sabitleyin ve kabloları korumak ve kısa devre yapmasını engellemek için metal parçalarla temas eden kabloların etrafını vinil bant sarın.

- Hoparlör kablolarını kendisine karşılık gelen doğru terminallere bağlayın. ⊖ kablolarını birden fazla birimle paylaşırır veya kabloları otomobilin içindeki metal kısımlarla topraklama yaptırırsanız, birim zarar görebilir ve çalışmayabilir.
- Sistemde yalnızca iki hoparlör bağlandığında, konektörleri hem ön çıkış terminallerine hem de arka çıkış terminallerine bağlayın (ön ve arka bölmeyi karıştırmayın). Örneğin, sol hoparlörün ⊕ konektörünü ön çıkış terminaline bağladığınızda, ⊖ konektörünü arka çıkış terminaline bağlamayın.
- Ünite takıldıktan sonra, fren lambalarının, sinyallerin, sileceklerin, vb. düzgün bir şekilde çalışıp çalışmadığını kontrol edin.
- Üniteyi montaj açısı 30° veya daha düşük olacak şekilde monte edin.
- Üniteyi araca monte ederken panel yüzeyine sertçe bastırmayın. Aksi takdirde yara izi, hasar veya arıza meydana gelebilir.
- Bluetooth anten yakınında metal nesnelere varsa alım alçalabilir.

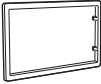

## Kurulum

### ■ Supplied accessories for installation

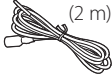
①		②		x1	x2
③		④		x1	x1
⑤				x1	

### ■ Kurulum prosedürü

- 1) Kısa devreyi engellemek için anahtar kontakları çıkarın ve  $\ominus$  akünün kutup başı bağlantısını çıkarın.
- 2) Her birim için doğru giriş ve çıkış kabloları bağlantıları yapın.
- 3) Kabloyu kablo demetine bağlayın.
- 4) Kablo demetindeki B Konektörünü alıp cihazınızdaki hoparlör konektörüne bağlayın.
- 5) Kablo demetindeki A Konektörünü alıp aracınızdaki harici güç konektörüne bağlayın.
- 6) Kablo demetindeki konektörünü birime takın.
- 7) Üniteyi araca monte edin.
- 8)  $\ominus$  akü kutup başını bağlayın.
- 9) Sıfırlama düğmesine basın.

## Birimin kurulumu

### ■ Japon olmayan arabalar

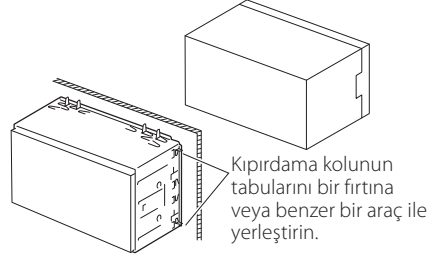

### NOT

- Birimin güvenli olarak yerleştirildiğinden emin olun. Eğer birim stabil değilse, yanlış çalışabilir (mesela ses atlayabilir).

### ■ Düzeltme plakası

- 1) Birliğe erişim ①'ini ekle.

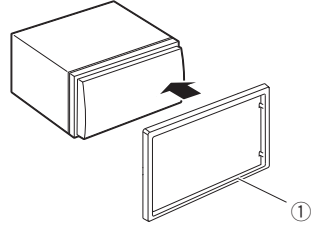

## Kurulum

### ■ Mikrofon birimi

- 1) Mikrofonun montaj konumunu kontrol edin (aksesuar ④).
- 2) Montaj yüzeyini temizleyin.
- 3) Mikrofon ayırıcıyı çıkarın (aksesuar ④) ve mikrofonu aşağıda gösterilen yere yapıştırın.
- 4) Mikrofon kablosunu, kaset veya başka istenen yöntemi kullanarak çeşitli konumlarda sabitlenmiş olarak birime bağlayın.
- 5) Mikrofonun yönünü (aksesuar ④) sürücüyü göre ayarlayın.

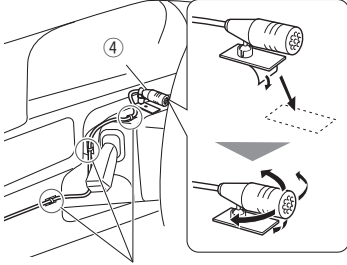

Ticari bir bant parçası olan bir kabloyu düzeltin.

### NOT

- Gerekirse klipsleri değiştirin.

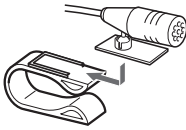

### ■ Trim plakasını sökme

- 1) Dört tırnağı (ikisi sol tarafta, ikisi sağ tarafta) kaldırmak için, çıkarma anahtarını (aksesuar ③) kullanın.

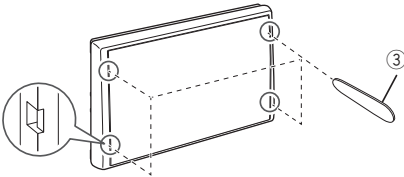

- 2) Düzeltme plakasını öne doğru çekin.

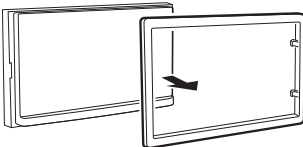

### ■ Birimi siliyor

- 1) "Kaldırım tabağını silerek 1 adım'a referans ediyoruz."
- 2) Gösterilen gibi yere çıkarma anahtarını (accessory ②) derinden koyun. Çıkarma anahtarının ucundaki durum birimlere karşı karşılaşmalı

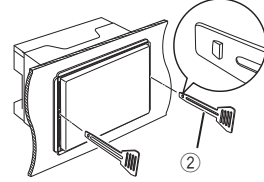

- 3) Yerleştirilmiş çıkarma anahtarını güvenli olarak, diğer çıkarma anahtarını yere koyun.

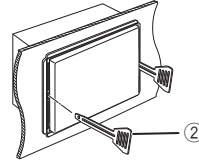

- 4) Birimi yarısına çıkar.

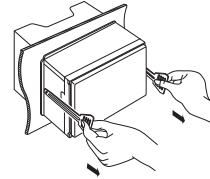

### NOT

- Çıkarma anahtarındaki yakalama piçlerinden yaralanmayı engellemek için dikkatli olun.
- 5) Birimi ellerinle dışarı çıkar, bırakmayı dikkatli ol.

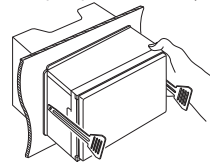

# Kurulum

## Kabloları terminallere bağlama

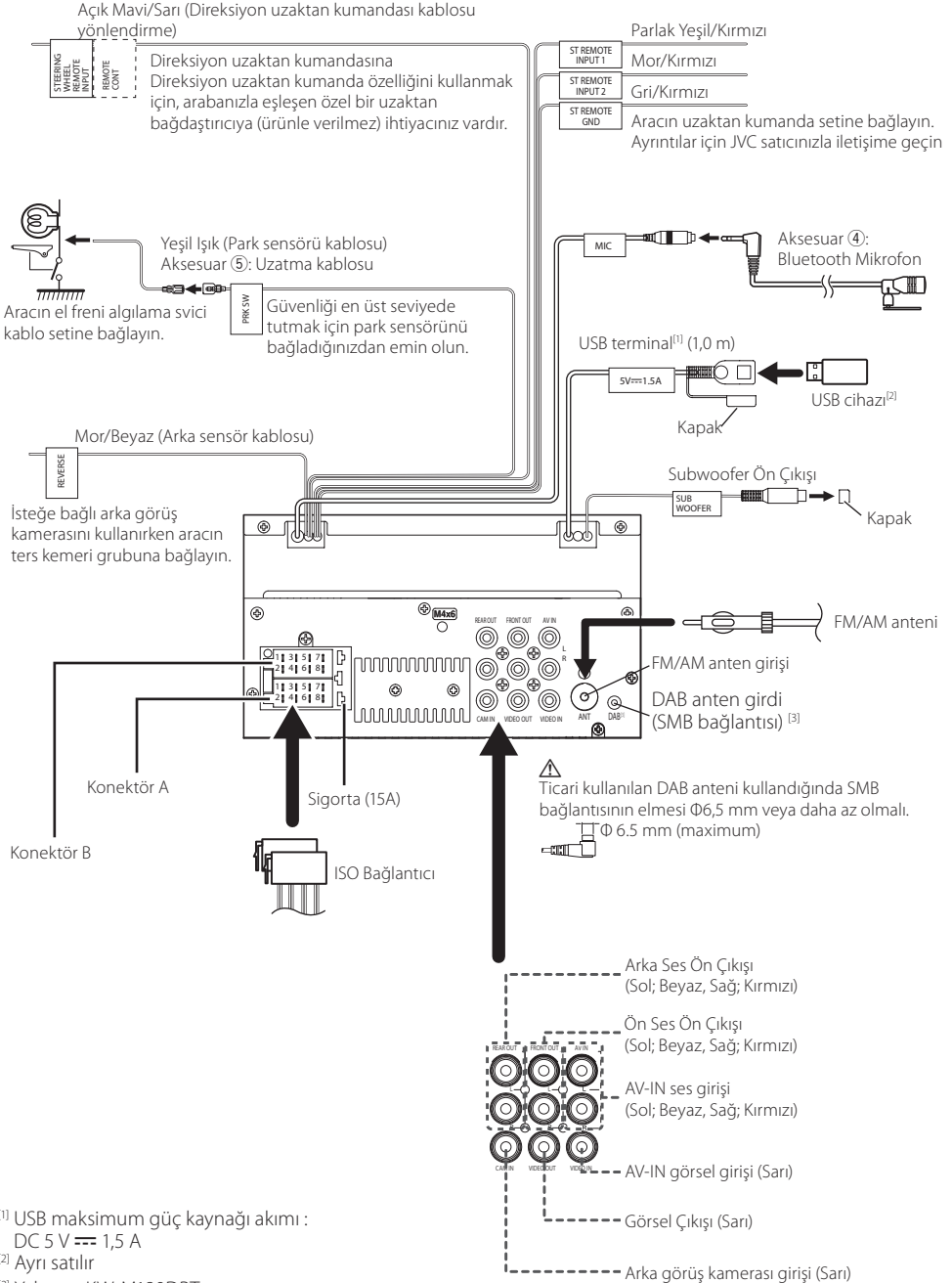

<sup>[1]</sup> USB maksimum güç kaynağı akımı :  
DC 5 V  $\pm$  1,5 A

<sup>[2]</sup> Ayrı satılır

<sup>[3]</sup> Yalnızca KW-M180DBT

## Kurulum

### ■ Kuvvetli bağlantı fonksiyonu rehberini siliyor

Pin	Renk ve fonksiyon
A-4	Sarı Batarya
A-5	Mavi <sup>[1]</sup> Güç Kontrolü
A-7	Kırmızı İlhamal (ACC)
A-8	Siyah Dünya (Yer) BağlantısıName
B-1/ B-2	Gümüş (+) / Gümüş/Siyah (-) Sağ arka
B-3/ B-4	Sıra (+) / Sıra/Siyah (-) Sağ önü
B-5/ B-6	Beyaz (+) / Beyaz/ Kara (-) Sol önünde
B-7/ B-8	Yeşil (+) / Yeşil/Siyah (-) Sol arkası

<sup>[1]</sup> Max. 150mA, 12V

- Konuşturucu sıkıntısı: 4-8 Ω

### ⚠ KAUCTION

Ticaret olarak kullanılabilir ISO bağlantılarını birimle bağlamadan önce, aşağıdaki şartları kontrol edin:

- Konektörün pin görevlerinin JVC birimi ile uyuşmasını sağlayın.
- Elektrik kablosunu daha fazla haber verin
- Batarya kablosu ve ateş kablosu uygun olmadığında bunları uygun şekilde değiştirin
- Arabanın ateş kablosu yoksa ticari olarak kullanın.

### ■ Bir iPhone/Android cihazın bağlanması

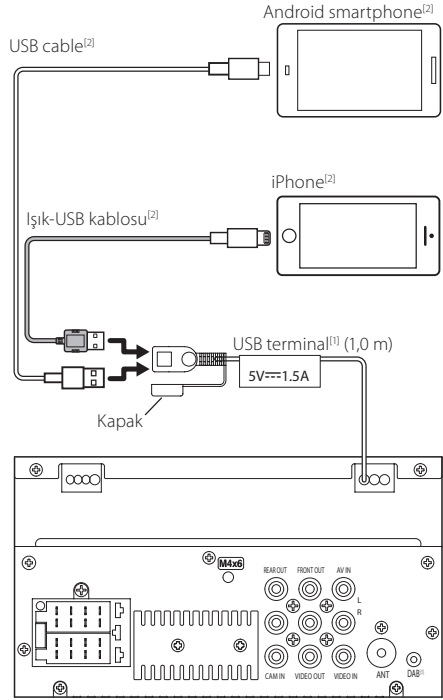

<sup>[1]</sup> USB maksimum güç kaynağı akımı :  
DC 5 V --- 1,5 A

<sup>[2]</sup> Ayrı satılır

<sup>[3]</sup> Yalnızca KW-M180DBT

# Bu Birim hakkında

## Daha fazla bilgi

### ■ Kullanılabilir USB cihazı

Bu ünite bir USB yığın depolama sınıfı cihazında kayıtlı MPEG1/ MPEG2/ MPEG4/ H.264/ MKV/ MP3/ WMA/ AAC/ WAV/ FLAC/ OGG dosyalarını çalabilir.

- Dosya sistemi: FAT16 / FAT32 / NTFS / exFAT
- Bu ünite toplam 9999 dosyayı ve 320 klasörü (klasör başına maksimum 9999 dosya) tanıyabilir.
- Maksimum karakter sayısı:
  - Klasör isimleri: 70 karakter
  - Dosya isimleri: 70 karakter
  - Etiket : 70 karakter

### NOT

- USB cihazı bu üniteye bağlandığında USB kablosu üzerinden şarj edilebilir.
- USB cihazını, güvenli sürüşü etkilemeyeceği yere kurun.
- USB aygıtını, USB hub ve Çoklu Kart Okuyucu vasıtasıyla bağlayamazsınız.
- Bu ünite ile kullanılan ses dosyalarının yedeklerini alın. Dosyalar, USB cihazının çalışma koşullarına bağlı olarak silinebilir. Silinen verilerden kaynaklanan hasarlar için hiçbir tazminat ödemeyeceğiz.
- Bu ünite ile USB cihazı verilmez. Piyasada satılan bir USB cihazı satın almanız gerekir.
- Kullanmadığınız her zaman USB terminalinin kapağını kapatın.

### ■ Çalınabilir Ses dosyaları

Ses formatı	Bit hızı/ (Bit sayısı)	Örnekleme frekansı
MP3 (.mp3)	16 – 320kbps, VBR	16 – 48 kHz
WMA (.wma)	16 – 320kbps	16 – 48 kHz
AAC-LC (.m4a)	16 – 320kbps	16 – 48 kHz
Linear PCM (WAVE) (.wav)	(16/24 bit)	8 – 192 kHz
FLAC (.flac)	(16/24 bit)	8 – 192 kHz
Vorbis (.ogg)	(16/24 bit)	8 – 192 kHz

- Bu ünite, ID3 Etiket Sürümü 1.0/1.1/2.2/2.3/2.4'ü gösterebilir (MP3 için).

### NOT

- WMA ve AAC'nin DRM ile kaplı olduğu durumlarda çalınmaz.
- Ses dosyaları yukarıda listelenen standartlara uymakla birlikte, ortam veya aygıtın türlerine veya koşullarına bağlı olarak oynatma imkansız olabilir.

### ■ Kabul edilebilir Video dosyaları

Video formatı	Video kod çözücüsü	Ses kodeki
MPEG-1 (.mpg, .mpeg)	MPEG-1	MPEG Audio Layer 2
MPEG-2 (.mpg, .mpeg)	MPEG-2	MPEG Audio Layer 2
MPEG-4 (.mp4, .avi)	MPEG-4 (SP,ASP)	MP3, AAC-LC (2ch)
H.264/MPEG-4 AVC (.mp4, .mkv, .avi, .flv, .f4v)	H.264/MPG-4 AVC (BP/MP/HP)	MP3, AAC (2ch)
MKV (.mkv)	Video Format follows H.264/ MPEG-4 AVC, MPEG4, XVID	MP3, AAC, Vorbis, FLAC

## Özellikler

### ■ Bluetooth bölümü

#### Frekans

: 2,4 – 2,48 GHz

#### RF Output Power (E.I.R.P.)

: +8dBm (MAX)

### ■ Audio bölümü

#### Hoparlör empedansı

: 4 – 8 Ω

### ■ Genel

#### Çalışma Voltajı

: 12 V DC araba aküsü



### Telif Hakları

- Bluetooth® sözcük markası ve logoları Bluetooth SIG, Inc.'in tescilli ticari markalarıdır ve bu markaların JVCKENWOOD Corporation tarafından tüm kullanıcıları lisans altındadır. Diğer ticari markalar ve ticari adlar kendi sahiplerine aittir.
- Use of the Made for Apple badge means that an accessory has been designed to connect specifically to the Apple product(s) identified in the badge, and has been certified by the developer to meet Apple performance standards. Apple is not responsible for the operation of this device or its compliance with safety and regulatory standards. Please note that the use of this accessory with an Apple product may affect wireless performance.
- Apple, iPhone and Lightning are trademarks of Apple Inc., registered in the U.S. and other countries.
- Android is a trademark of Google LLC.
- Microsoft and Windows Media are either registered trademarks or trademarks of Microsoft Corporation in the United States and/or other countries.
- THIS PRODUCT IS LICENSED UNDER THE MPEG-4 VISUAL PATENT PORTFOLIO LICENSE FOR THE PERSONAL AND NON-COMMERCIAL USE OF A CONSUMER FOR (i) ENCODING VIDEO IN COMPLIANCE WITH THE MPEG-4 VISUAL STANDARD ("MPEG-4 VIDEO") AND/OR (ii) DECODING MPEG-4 VIDEO THAT WAS ENCODED BY A CONSUMER ENGAGED IN A PERSONAL AND NON-COMMERCIAL ACTIVITY AND/OR WAS OBTAINED FROM A VIDEO PROVIDER LICENSED BY MPEG LA TO PROVIDE MPEG-4 VIDEO. NO LICENSE IS GRANTED OR SHALL BE IMPLIED FOR ANY OTHER USE. ADDITIONAL INFORMATION INCLUDING THAT RELATING TO PROMOTIONAL, INTERNAL AND COMMERCIAL USES AND LICENSING MAY BE OBTAINED FROM MPEG LA, LLC. SEE [HTTP://WWW.MPEGLA.COM](http://www.mpegla.com).
- THIS PRODUCT IS LICENSED UNDER THE AVC PATENT PORTFOLIO LICENSE FOR THE PERSONAL USE OF A CONSUMER OR OTHER USES IN WHICH IT DOES NOT RECEIVE REMUNERATION TO (i) ENCODE VIDEO IN COMPLIANCE WITH THE AVC STANDARD ("AVC VIDEO") AND/OR (ii) DECODE AVC VIDEO THAT WAS ENCODED BY A CONSUMER ENGAGED IN A PERSONAL ACTIVITY AND/OR WAS OBTAINED FROM A VIDEO PROVIDER LICENSED TO PROVIDE AVC VIDEO. NO LICENSE IS GRANTED OR SHALL BE IMPLIED FOR ANY OTHER USE. ADDITIONAL INFORMATION MAY BE OBTAINED FROM MPEG LA, L.L.C. SEE [HTTP://WWW.MPEGLA.COM](http://www.mpegla.com)
- libFLAC  
Copyright (C) 2000-2009 Josh Coalson  
Copyright (C) 2011-2013 Xiph.Org Foundation
  - Redistribution and use in source and binary forms, with or without modification, are permitted provided that the following conditions are met:
  - Redistributions of source code must retain the above copyright notice, this list of conditions and the following disclaimer.

– Redistributions in binary form must reproduce the above copyright notice, this list of conditions and the following disclaimer in the documentation and/or other materials provided with the distribution.

Neither the name of the Xiph.org Foundation nor the names of its contributors may be used to endorse or promote products derived from this software without specific prior written permission.

THIS SOFTWARE IS PROVIDED BY THE COPYRIGHT HOLDERS AND CONTRIBUTORS "AS IS" AND ANY EXPRESS OR IMPLIED WARRANTIES, INCLUDING, BUT NOT LIMITED TO, THE IMPLIED WARRANTIES OF MERCHANTABILITY AND FITNESS FOR A PARTICULAR PURPOSE ARE DISCLAIMED. IN NO EVENT SHALL THE FOUNDATION OR CONTRIBUTORS BE LIABLE FOR ANY DIRECT, INDIRECT, INCIDENTAL, SPECIAL, EXEMPLARY, OR CONSEQUENTIAL DAMAGES (INCLUDING, BUT NOT LIMITED TO, PROCUREMENT OF SUBSTITUTE GOODS OR SERVICES; LOSS OF USE, DATA, OR PROFITS; OR BUSINESS INTERRUPTION) HOWEVER CAUSED AND ON ANY THEORY OF LIABILITY, WHETHER IN CONTRACT, STRICT LIABILITY, OR TORT (INCLUDING NEGLIGENCE OR OTHERWISE) ARISING IN ANY WAY OUT OF THE USE OF THIS SOFTWARE, EVEN IF ADVISED OF THE POSSIBILITY OF SUCH DAMAGE.

#### • libogg

Copyright (c) 2002, Xiph.org Foundation Redistribution and use in source and binary forms, with or without modification, are permitted provided that the following conditions are met:

– Redistributions of source code must retain the above copyright notice, this list of conditions and the following disclaimer.

– Redistributions in binary form must reproduce the above copyright notice, this list of conditions and the following disclaimer in the documentation and/or other materials provided with the distribution.

– Neither the name of the Xiph.org Foundation nor the names of its contributors may be used to endorse or promote products derived from this software without specific prior written permission.

THIS SOFTWARE IS PROVIDED BY THE COPYRIGHT HOLDERS AND CONTRIBUTORS "AS IS" AND ANY EXPRESS OR IMPLIED WARRANTIES, INCLUDING, BUT NOT LIMITED TO, THE IMPLIED WARRANTIES OF MERCHANTABILITY AND FITNESS FOR A PARTICULAR PURPOSE ARE DISCLAIMED. IN NO EVENT SHALL THE FOUNDATION OR CONTRIBUTORS BE LIABLE FOR ANY DIRECT, INDIRECT, INCIDENTAL, SPECIAL, EXEMPLARY, OR CONSEQUENTIAL DAMAGES (INCLUDING, BUT NOT LIMITED TO, PROCUREMENT OF SUBSTITUTE GOODS OR SERVICES; LOSS OF USE, DATA, OR PROFITS; OR BUSINESS INTERRUPTION) HOWEVER CAUSED AND ON ANY THEORY OF LIABILITY, WHETHER IN CONTRACT, STRICT LIABILITY, OR TORT (INCLUDING NEGLIGENCE OR OTHERWISE) ARISING IN ANY WAY OUT OF THE USE OF THIS SOFTWARE, EVEN IF ADVISED OF THE POSSIBILITY OF SUCH DAMAGE.

## Information on Disposal of Old Electrical and Electronic Equipment and Batteries (applicable for EU countries that have adopted separate waste collection systems)

Products and batteries with the symbol (crossed-out wheeled bin) cannot be disposed as household waste. Old electrical and electronic equipment and batteries should be recycled at a facility capable of handling these items and their waste byproducts.

Contact your local authority for details in locating a recycle facility nearest to you.

Proper recycling and waste disposal will help conserve resources whilst preventing detrimental effects on our health and the environment.



## מידע בדבר השלכה לאשפה של ציוד חשמלי ואלקטרוני ישן וכן סוללות (רלוונטי למדינות שמשמשות במערכת איסוף אשפה מופרדת).

לא ניתן להשליך מוצרים וסוללות עם הסימון (פח אשפה עם X עליו) כאשפה ביתית רגילה.

יש למחזר ציוד חשמלי ואלקטרוני ישן וכן סוללות במתקן המסוגל לטפל בפריטים כאלה ובתוצרי הלוואי שלהם.

צרו קשר עם הרשות המקומית לקבלת פרטים אודות מתקן המיחזור הקרוב אליכם. מיחזור והשלכה לאשפה נאותים יעזרו לשמר משאבים ולמנוע השפעות שליליות על בריאותנו ועל הסביבה.



## Informations sur l'élimination des anciens équipements électriques et électroniques et piles électriques (applicables dans les pays européens qui ont adopté des systèmes de collecte sélective)

Les produits et piles électriques sur lesquels le pictogramme (poubelle barrée) est apposé ne peuvent pas être éliminés comme ordures ménagères. Les anciens équipements électriques et électroniques et les piles électriques doivent être recyclés sur des sites capables de traiter ces produits et leurs sous-produits déchets.

Contactez vos autorités locales pour connaître le site de recyclage le plus proche.

Un recyclage adapté et l'élimination des déchets aideront à conserver les ressources et à nous préserver des leurs effets nocifs sur notre santé et sur l'environnement.

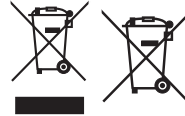

## Entsorgung von gebrauchten elektrischen und elektronischen Geräten und Batterien (anzuwenden in EU-Ländern mit einem separaten Sammelsystem für solche Geräte)

Das Symbol (durchgestrichene Mülltonne) auf dem Produkt oder seiner Verpackung weist darauf hin, dass dieses Produkt nicht als normaler Haushaltsabfall behandelt werden darf.

Alte elektrische und elektronische Geräte müssen in einer Anlage recycelt werden, die für den Umgang mit diesen Artikeln und dem Begleitabfall geeignet sind. Unsachgemäße oder falsche Entsorgung gefährden Umwelt und Gesundheit.

Weitere Informationen über das Recycling dieses Produktes erhalten Sie von Ihrer Gemeinde oder den kommunalen Entsorgungsbetrieben.



## **■ Informatie over het weggoien van gebruikte elektrische en elektronische apparatuur en batterijen (voor EU-landen die gescheiden vuilverwerkingssystemen gebruiken)**

Producten en batterijen met dit symbool (doorkruiste vuilnisbak) kunnen niet als gewoon huisvuil worden weggegooid.

Oude elektrische en elektronische apparaten en batterijen moeten worden gerecycled door een hiervoor geschikte faciliteit.

Raadpleeg de lokale betreffende instantie voor details aangaande een geschikte recycle-faciliteit in uw buurt.

Het juist recyclen en weggoien van vuil helpt bronnen te besparen en vermindert een schadelijke invloed op uw gezondheid en het milieu.



## **■ Informazioni sull'eliminazione dei prodotti elettrici ed elettronici e delle batterie (per i paesi UE che adottano la raccolta differenziata dei rifiuti)**

I prodotti e le batterie che recano questo simbolo (bidone della spazzatura barrato con una croce) non devono essere eliminati come rifiuti solidi urbani.

I prodotti elettrici ed elettronici nonché le batterie devono essere riciclati in appositi centri attrezzati anche per la gestione dei prodotti da essi derivati.

Per informazioni dettagliate sui centri di riciclaggio più vicini si suggerisce di chiedere al proprio rivenditore.

Se eseguiti correttamente, l'eliminazione e il riciclaggio di questi prodotti aiutano a conservare le risorse e a prevenire gli effetti nocivi sulla salute e l'ambiente.



## **■ Información acerca de la eliminación de equipos eléctricos, electrónicos y baterías al final de su vida útil (aplicable a los países de la UE que hayan adoptado sistemas independientes de recogida de residuos)**

Los productos y las pilas con el símbolo (cubo de basura tachado) no podrán ser desechados como residuos domésticos.

Las pilas y los equipos eléctricos y electrónicos usados se deben reciclar en instalaciones que gestionen tales elementos y residuos.

Póngase en contacto con la autoridad local para obtener detalles acerca de una planta de reciclaje cercana.

Un reciclaje y tratamiento de residuos correcto ayudará a conservar los recursos a la vez que evitará efectos perjudiciales para nuestra salud y el medio ambiente.



## **■ Informações sobre a Eliminação de Baterias e de Equipamentos Elétricos e Eletrônicos Usados (aplicável nos países da UE que adotaram sistemas de recolha separada de resíduos)**

Produtos e baterias com o símbolo (contentor de lixo com rodas barrado com uma cruz) não podem ser eliminados como lixo doméstico.

As baterias e os equipamentos elétricos e eletrônicos usados devem ser reciclados em uma instalação capaz de manusear esses itens e seus subprodutos residuais.

Contacte a autoridade local para os detalhes sobre a localização da instalação de reciclagem mais próxima.

A reciclagem e eliminação de lixo adequada ajudará a preservar os recursos naturais, ao mesmo tempo que prevenirá efeitos prejudiciais à nossa saúde e meio ambiente.



**Eski Elektrik ve Elektronik Ekipmanların İmha Edilmesi Hakkında Bilgi (ayrı atık toplama sistemlerini kullanan ülkeleri için uygulanabilir)**

Sembollü (üzerinde çarpı işareti olan çöp kutusu) ürünler ev atıkları olarak atılamaz.

Eski elektrik ve elektronik ekipmanlar, bu ürünleri ve ürün atıklarını geri dönüştürebilecek bir tesiste değerlendirilmelidir.

Yaşadığınız bölgeye en yakın geri dönüşüm tesisinin yerini öğrenmek için yerel makamlara müracaat edin. Uygun geri dönüşüm ve atık imha yöntemi sağlığımız ve çevremiz üzerindeki zararlı etkileri önlerken kaynakların korunmasına da yardımcı olacaktır.



**UK  
CA**

**Declaration of Conformity with regard to the Radio Equipment Regulations 2017 (S.I. 2017/1206)**

**Declaration of Conformity with regard to the Restriction of the Use of Certain Hazardous Substances in Electrical and Electronic Equipment Regulations 2012 (S.I. 2012/3032)**

**Manufacturer:**

JVCKENWOOD Corporation  
3-12, Moriya-cho, Kanagawa-ku, Yokohama-shi, Kanagawa,  
221-0022, JAPAN

**UK Importer:**

JVCKENWOOD U.K. Limited  
First Floor, Gleneagles, the Belfry, Colonial Way, Watford,  
Hertfordshire WD24 4WH, UNITED KINGDOM

Hereby, JVCKENWOOD declares that the radio equipment "KW-M180DBT" /"KW-M180BT" is in compliance with the relevant statutory requirements. The full text of the declaration of conformity is available at the following internet address:<https://www.jvc.net/euukdoc/>



**Declaration of Conformity with regard to the RE Directive 2014/53/EU**

**Declaration of Conformity with regard to the RoHS Directive 2011/65/EU**

**Manufacturer:**

JVCKENWOOD Corporation  
3-12, Moriyacho, Kanagawa-ku, Yokohama-shi,  
Kanagawa 221-0022, JAPAN

**EU Representative:**

JVCKENWOOD Europe B.V.  
Rendementsweg 20 B-9, 3641 SL Mijdrecht, THE  
NETHERLANDS

**Déclaration de conformité se rapportant à la directive RE 2014/53/UE**

**Déclaration de conformité se rapportant à la directive RoHS 2011/65/UE**

**Fabricant:**

JVCKENWOOD Corporation  
3-12, Moriyacho, Kanagawa-ku, Yokohama-shi,  
Kanagawa 221-0022, JAPAN

**Représentant dans l'UE :**

JVCKENWOOD Europe B.V.  
Rendementsweg 20 B-9, 3641 SL Mijdrecht, THE  
PAYS-BAS

**Konformitätserklärung in Bezug auf die RERichtlinie 2014/53/EU**

**Konformitätserklärung in Bezug auf die RoHSRichtlinie 2011/65/EU**

**Hersteller:**

JVCKENWOOD Corporation  
3-12, Moriyacho, Kanagawa-ku, Yokohama-shi,  
Kanagawa 221-0022, JAPAN

**EU-Vertreter:**

JVCKENWOOD Europa B.V.  
Rendementsweg 20 B-9, 3641 SL Mijdrecht, THE  
NIEDERLANDE

**Conformiteitsverklaring met betrekking tot RE-richtlijn 2014/53/EU**

**Conformiteitsverklaring met betrekking tot RoHS-richtlijn 2011/65/EU**

**Fabrikant:**

JVCKENWOOD Corporation  
3-12, Moriyacho, Kanagawa-ku, Yokohama-shi,  
Kanagawa 221-0022, JAPAN

**EU-vertegenwoordiger:**

JVCKENWOOD Europa B.V.  
Rendementsweg 20 B-9, 3641 SL Mijdrecht, THE  
NEDERLAND

**Dichiarazione di conformità relativa alla direttiva RE 2014/53/UE**

**Dichiarazione di conformità relativa alla direttiva RoHS 2011/65/UE**

**Produttore:**

JVCKENWOOD Corporation  
3-12, Moriyacho, Kanagawa-ku, Yokohama-shi,  
Kanagawa 221-0022, JAPAN

**Rappresentante UE:**

JVCKENWOOD Europe B.V.  
Rendementsweg 20 B-9, 3641 SL Mijdrecht, THE  
PAESI BASSI

**Declaración de conformidad con respecto a la Directiva RE 2014/53/UE**

**Declaración de conformidad con respecto a la Directiva RoHS 2011/65/UE**

**Fabricante:**

JVCKENWOOD Corporation  
3-12, Moriyacho, Kanagawa-ku, Yokohama-shi,  
Kanagawa 221-0022, JAPAN

**Representante en la UE:**

JVCKENWOOD Europe B.V.  
Rendementsweg 20 B-9, 3641 SL Mijdrecht, THE  
PAÍSES BAJOS

**Declaração de Conformidade relativa à Diretiva RE 2014/53/UE**

**Declaração de conformidade relativa à Diretiva RoHS 2011/65/UE**

**Fabricante:**

JVCKENWOOD Corporation  
3-12, Moriyacho, Kanagawa-ku, Yokohama-shi,  
Kanagawa 221-0022, JAPÃO

**Representante na UE:**

JVCKENWOOD Europe B.V.  
Rendementsweg 20 B-9, 3641 SL Mijdrecht, THE  
PAÍSES BAIXOS

**2014/53/EU RE Direktifi ile Uyumluluk Beyanı**

**RoHS Direktifi 2011/65/EU için Uyum Beyanı**

**Üretici:**

JVCKENWOOD Corporation  
3-12, Moriyacho, Kanagawa-ku, Yokohama-shi,  
Kanagawa 221-0022, JAPONYA

**AB Temsilcisi:**

JVCKENWOOD Europe B.V.  
Rendementsweg 20 B-9, 3641 SL Mijdrecht, THE  
HOLLANDA

## English

Hereby, JVCENWOOD declares that the radio equipment "KW-M180DBT"/"KW-M180BT" is in compliance with Directive 2014/53/EU. The full text of the EU declaration of conformity is available at the following internet address:

## French

Par la présente, JVCENWOOD déclare que l'équipement radio "KW-M180DBT"/"KW-M180BT" est conforme à la directive 2014/53/UE. L'intégralité de la déclaration de conformité UE est disponible à l'adresse Internet suivante :

## Deutsch

Hiermit erkläre JVCENWOOD, dass das Funkgerät "KW-M180DBT"/"KW-M180BT" der Richtlinie 2014/53/EU entspricht. Der volle Text der EU-Konformitätserklärung steht unter der folgenden Internetadresse zur Verfügung:

## Nederlands

Hierbij verklaart JVCENWOOD dat de radioapparatuur "KW-M180DBT"/"KW-M180BT" in overeenstemming is met Richtlijn 2014/53/EU. De volledige tekst van de EU-verklaring van overeenstemming is te vinden op het volgende internetadres:

## Italiano

Con la presente, JVCENWOOD dichiara che l'apparecchio radio "KW-M180DBT"/"KW-M180BT" è conforme alla Direttiva 2014/53/UE. Il testo integrale della dichiarazione di conformità UE è disponibile al seguente indirizzo internet:

## Español

Por la presente, JVCENWOOD declara que el equipo de radio "KW-M180DBT"/"KW-M180BT" cumple la Directiva 2014/53/UE. El texto completo de la declaración de conformidad con la UE está disponible en la siguiente dirección de internet:

## Português

Deste modo, a JVCENWOOD declara que o equipamento de rádio "KW-M180DBT"/"KW-M180BT" está em conformidade com a Diretiva 2014/53/UE. O texto integral da declaração de conformidade da UE está disponível no seguinte endereço de internet:

## Polska

Niniejszym, JVCENWOOD deklaruje, że sprzęt radiowy "KW-M180DBT"/"KW-M180BT" jest zgodny z dyrektywą 2014/53/UE. Pełny tekst deklaracji zgodności EU jest dostępny pod adresem:

## Česky

Společnost JVCENWOOD tímto prohlašuje, že rádiové zařízení "KW-M180DBT"/"KW-M180BT" splňuje podmínky směrnice 2014/53/UE. Plný text EU prohlášení o shodě je dostupný na následující internetové adrese:

## Magyar

JVCENWOOD ezennel kijelenti, hogy a "KW-M180DBT"/"KW-M180BT" rádióberendezés megfelel a 2014/53/EU irányelvnek. Az EU konformitási nyilatkozat teljes szövege az alábbi weboldalon érhető el:

## Hrvatski

JVCENWOOD ovim izjavljuje da je radio oprema "KW-M180DBT"/"KW-M180BT" u skladu s Direktivom 2014/53/EU. Cjeloviti tekst deklaracije Europske unije o usklađenosti dostupan je na sljedećoj internet adresi:

## Svenska

Härmed försäkras JVCENWOOD att radioutrustningen "KW-M180DBT"/"KW-M180BT" är i enlighet med direktiv 2014/53/EU. Den fullständiga texten av EU-försäkran om överensstämmelse finns på följande Internetadress:

## Suomi

JVCENWOOD julistaa täten, että radiolaitte "KW-M180DBT"/"KW-M180BT" on direktiivin 2014/53/EU mukainen. EU-vaatimustenmukaisuusvakuutus löytyy kokonaisuudessaan seuraavasta internet-osoitteesta:

## Slovensko

S tem JVCENWOOD izjavlja, da je radijska oprema "KW-M180DBT"/"KW-M180BT" v skladu z Direktivo 2014/53/EU. Celotno besedilo direktive EU o skladnosti je dostopno na tem spletnem naslovu:

## Slovensky

Spoločnosť JVCENWOOD týmto vyhlasuje, že rádiové zariadenie "KW-M180DBT"/"KW-M180BT" vyhovuje smernici 2014/53/EU. Celý text EU vyhlásenia o zhode nájdete na nasledovnej internetovej adrese:

## Dansk

Herved erklærer JVCENWOOD, at radioustyret "KW-M180DBT"/"KW-M180BT" er i overensstemmelse med Direktiv 2014/53/EU. EU-oversensstemmelseerklæringens fulde ordlyd er tilgængelig på følgende internetadresse:

## Norsk

JVCENWOOD erklærer herved at radioustyret "KW-M180DBT"/"KW-M180BT" er i samsvar med Direktiv 2014/53/EU. Den fullstendige teksten til EU-konformitetserklæringen er tilgjengelig på følgende internetadresse:

## Ελληνικά

Με το παρόν, η JVCENWOOD δηλώνει ότι ο ραδιοεξοπλισμός "KW-M180DBT"/"KW-M180BT" συμμορφώνεται με την Οδηγία 2014/53/ΕΕ. Το πλήρες κείμενο της δήλωσης συμμόρφωσης της ΕΕ είναι διαθέσιμο στην ακόλουθη διεύθυνση στο διαδίκτυο:

## Eesti

Käesolevaga JVCENWOOD kinnitab, et "KW-M180DBT"/"KW-M180BT" raadiovarusust on vastavuses direktiiviga 2014/53/EL. Eli vastavusdeklaratsiooni terviktekst on kättesaadav järgmisel internetiaadressil:

## Latviešu

JVCENWOOD ar šo deklarē, ka radio aparatūra "KW-M180DBT"/"KW-M180BT" atbilst direktivas 2014/53/ES prasībām. Pilns ES atbilstības deklarācijas teksts ir pieejams šādā tīmekļa adresē:

## Lietuviškai

Šiuo JVCENWOOD pažymi, kad radijo įranga "KW-M180DBT"/"KW-M180BT" atitinka 2014/53/EB direktyvos reikalavimus. Visą EB direktyvos atitikties deklaracijos tekstą galite rasti šiuo internetiniu adresu:

## Malti

B'dan, JVCENWOOD jiddikjara li t-taghmir tar-radju "KW-M180DBT"/"KW-M180BT" huwa konformi mad-Direttiva 2014/53/UE. It-test kollu tad-dikjarazzjoni ta' konformita huwa disponibbli fl-indirizz intranet li hej:

## Українська

Таким чином, компанія JVCENWOOD заявляє, що радіообладнання "KW-M180DBT"/"KW-M180BT" відповідає Директиві 2014/53/ЄУ. Повний текст декларації про відповідність ЄС можна знайти в Інтернеті за такою адресою:

## Türkçe

Burada, JVCENWOOD "KW-M180DBT"/"KW-M180BT" radyo ekipmanının 2014/53/AB Direktifine uygun olduğunu bildirir. AB uyumluluk deklarasyonunun tam metni aşağıdaki internet adresinde mevcuttur.

## Русский

JVCENWOOD настоящим заявляет, что радиооборудование "KW-M180DBT"/"KW-M180BT" соответствует Директиве 2014/53/ЕУ. Полный текст декларации соответствия ЕС доступен по следующему адресу в сети Интернет:

## Limba română

Prin prezenta, JVCENWOOD declară că echipamentul radio "KW-M180DBT"/"KW-M180BT" este în conformitate cu Directiva 2014/53/UE. Textul integral al declarației de conformitate UE este disponibil la următoarea adresă de internet:

## Български език

С настоящото JVCENWOOD декларира, че радиооборудването на "KW-M180DBT"/"KW-M180BT" е в съответствие с Директива 2014/53/ЕС. Пълният текст на ЕС декларацията за съответствие е достъпен на следния интернет адрес:



**JVC**